

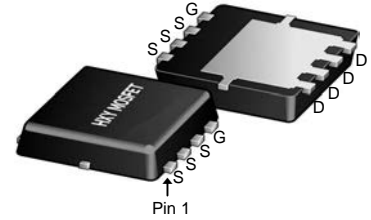

## General Description

The BSC0702LS use advanced SGT MOSFET technology to provide low RDS(ON), low gate charge, fast switching and excellent avalanche characteristics.

This device is specially designed to get better ruggedness and suitable to use in



DFN5X6-8L

## General Features

$V_{DS} = 60V$   $I_D = 125A$

$R_{DS(ON)} < 2.9m\Omega @ V_{GS} = 10V$

## Applications

Consumer electronic power supply Motor control

Synchronous-rectification Isolated DC

Synchronous-rectification applications

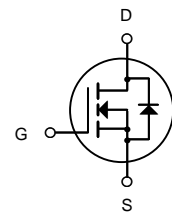

N-Channel MOSFET

## Package Marking and Ordering Information

Product ID	Pack	Marking	Qty(PCS)
BSC0702LS	DFN5X6-8L	0702LS XXXX	5000

## Absolute Maximum Ratings ( $T_C = 25^\circ C$ unless otherwise noted)

Symbol	Parameter	Rating	Units
$V_{DS}$	Drain-Source Voltage	60	V
$V_{GS}$	Gate-Source Voltage	$\pm 20$	V
$I_D @ T_C = 25^\circ C$	Continuous Drain Current, $V_{GS} @ 10V$	125	A
$I_D @ T_C = 100^\circ C$	Continuous Drain Current, $V_{GS} @ 10V$	101	A
$I_{DM}$	Pulsed Drain Current <sup>2</sup>	641	A
EAS	Single Pulse Avalanche Energy <sup>3</sup>	189	mJ
$P_D @ T_C = 25^\circ C$	Total Power Dissipation <sup>4</sup>	113	W
$T_{STG}$	Storage Temperature Range	-55 to 150	$^\circ C$
$T_J$	Operating Junction Temperature Range	-55 to 150	$^\circ C$
$R_{\theta JC}$	Thermal Resistance from Junction-to-Ambient <sup>3</sup>	1.11	$^\circ C/W$
$R_{\theta JA}$	Thermal Resistance Junction-Ambient <sup>1</sup>	39.4	$^\circ C/W$



**Electrical Characteristics** ( $T_J=25^\circ\text{C}$  unless otherwise specified)

Symbol	Parameter	Test Condition	Min.	Typ.	Max.	Units
$V_{(BR)DSS}$	Drain-Source Breakdown Voltage	$V_{GS}=0V, I_D=250\mu A$	60	-	-	V
$I_{DSS}$	Zero Gate Voltage Drain Current	$V_{DS}=60V, V_{GS}=0V,$	-	-	1.0	$\mu A$
$I_{GSS}$	Gate to Body Leakage Current	$V_{DS}=0V, V_{GS}=\pm 20V$	-	-	$\pm 100$	nA
$V_{GS(th)}$	Gate Threshold Voltage	$V_{DS}=V_{GS}, I_D=250\mu A$	1.2	1.6	2.2	V
$R_{DS(on)}$	Static Drain-Source on-Resistance <small>note3</small>	$V_{GS}=10V, I_D=20A$	-	2.4	2.9	m $\Omega$
$C_{iss}$	Input Capacitance	$V_{DS}=30V, V_{GS}=0V,$ $f=1.0MHz$	-	4610	6915	pF
$C_{oss}$	Output Capacitance		-	2188	3282	pF
$C_{rss}$	Reverse Transfer Capacitance		-	66	132	pF
$Q_g$	Total Gate Charge	$V_{DS}=30V, I_D=40A,$ $V_{GS}=10V$	-	74.37	111.56	nC
$Q_{gs}$	Gate-Source Charge		-	17.26	-	nC
$Q_{gd}$	Gate-Drain("Miller") Charge		-	9.44	18.88	nC
$t_{d(on)}$	Turn-on Delay Time	$V_{DD}=30V, I_D=40A,$ $R_G=2.7\Omega, V_{GS}=10V$	-	14.13	-	ns
$t_r$	Turn-on Rise Time		-	63.73	-	ns
$t_{d(off)}$	Turn-off Delay Time		-	46.8	-	ns
$t_f$	Turn-off Fall Time		-	105.07	-	ns
$I_S$	Maximum Continuous Drain to Source Diode Forward Current		-	-	125	A
$I_{SM}$	Maximum Pulsed Drain to Source Diode Forward Current		-	-	641	A
$V_{SD}$	Drain to Source Diode Forward Voltage	$V_{GS}=0V, I_S=40A$	-	-	1.2	V
$t_{rr}$	Body Diode Reverse Recovery Time	$T_J=25^\circ\text{C},$ $I_F=40A, di/dt=100A/\mu s$	-	52.78	105.56	ns
$Q_{rr}$	Body Diode Reverse Recovery Charge		-	56.31	112.62	nC

Notes:1. Repetitive Rating: Pulse Width Limited by Maximum Junction Temperature

2. EAS condition:  $T_J=25^\circ\text{C}, V_{DD}=30V, V_G=10V, R_G=25\Omega, L=0.5mH, I_{AS}=12A$

3. Pulse Test: Pulse Width $\leq 300\mu s$ , Duty Cycle $\leq 0.5\%$



### Typical Characteristics

Fig 1: Output Characteristics

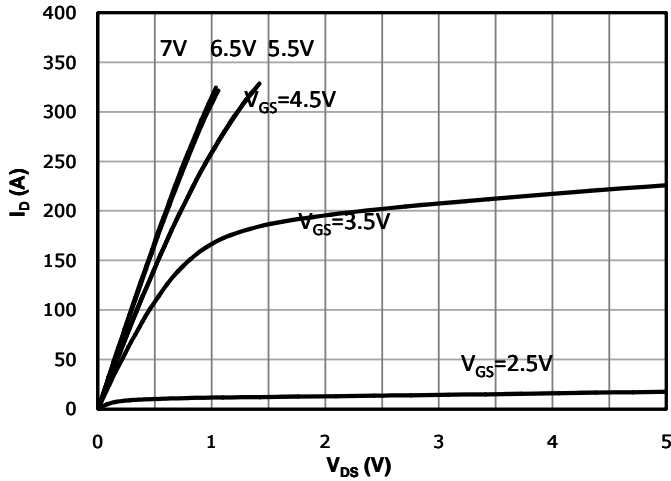

Fig 2: Transfer Characteristics

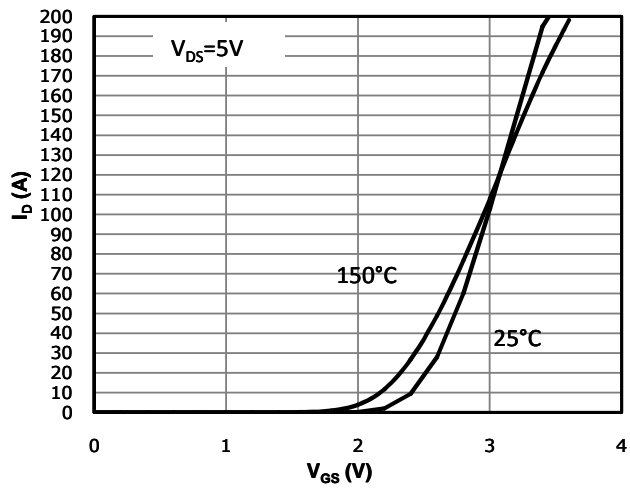

Fig 3:  $R_{DS(on)}$  vs Drain Current and Gate Voltage

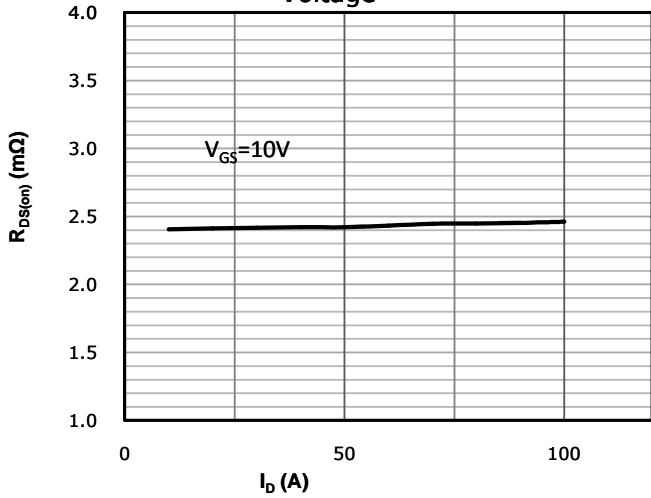

Fig 4:  $R_{DS(on)}$  vs Gate Voltage

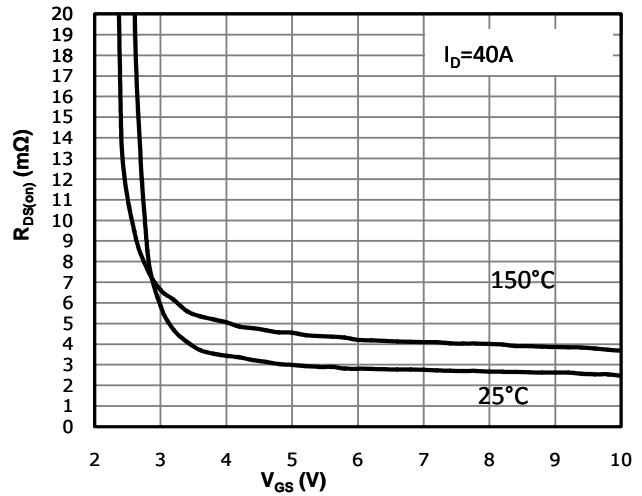

Fig 5:  $R_{DS(on)}$  vs. Temperature

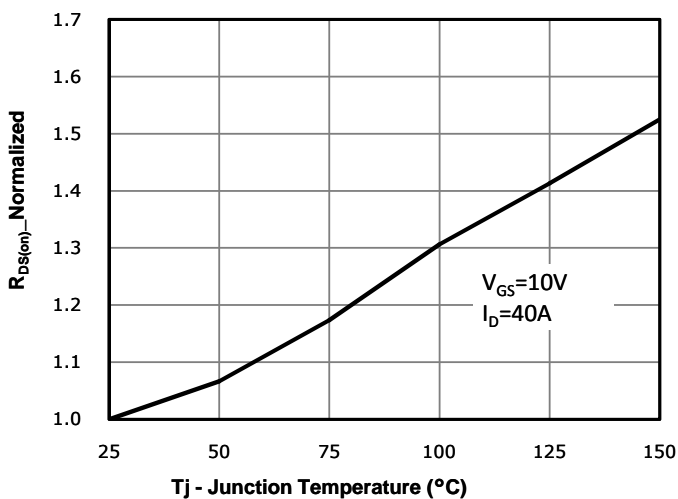

Fig 6: Capacitance Characteristics

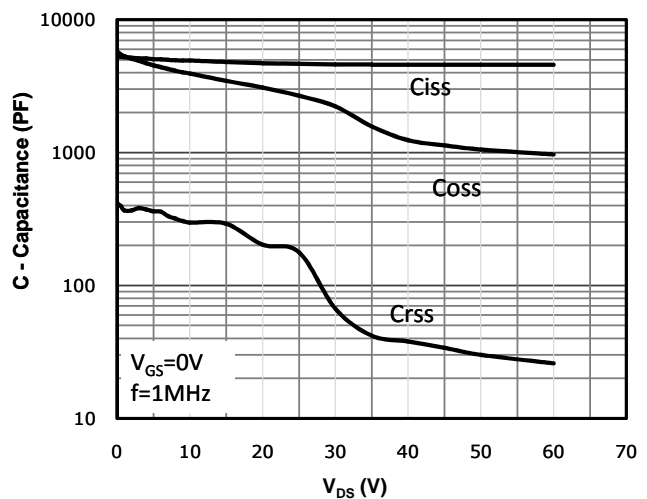



Fig 7: Gate Charge Characteristics

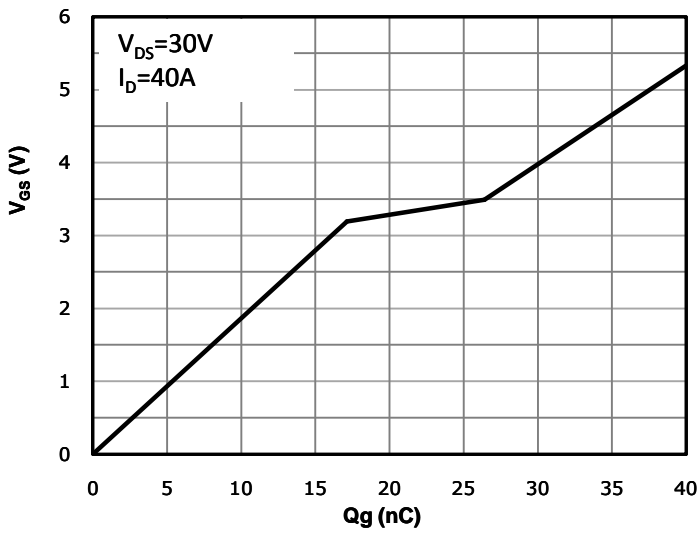

Fig 8: Body-diode Forward Characteristics

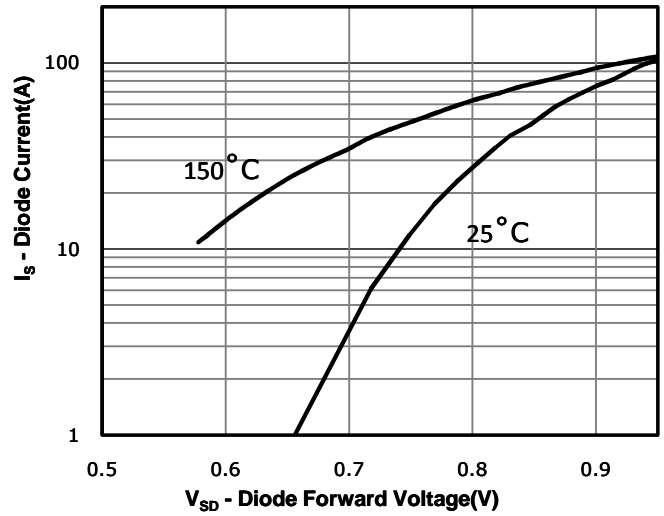

Fig 9: Power Dissipation

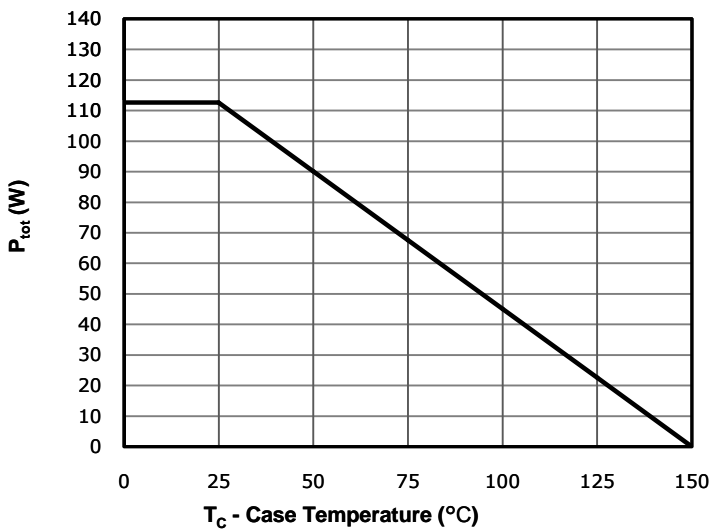

Fig 10: Drain Current Derating

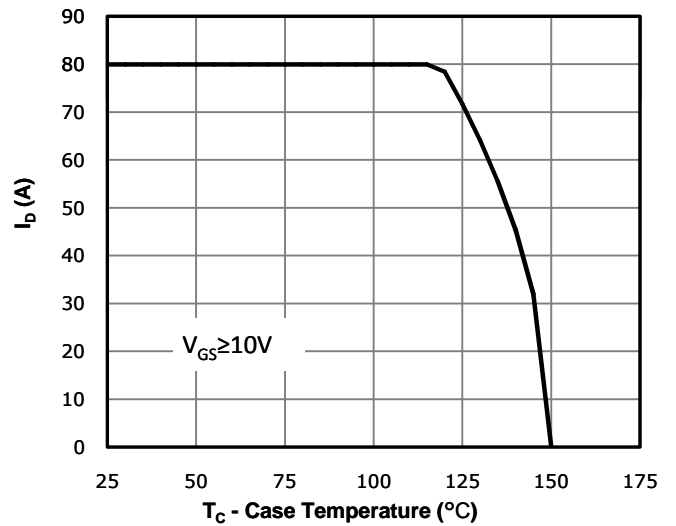

Fig 11: Safe Operating Area

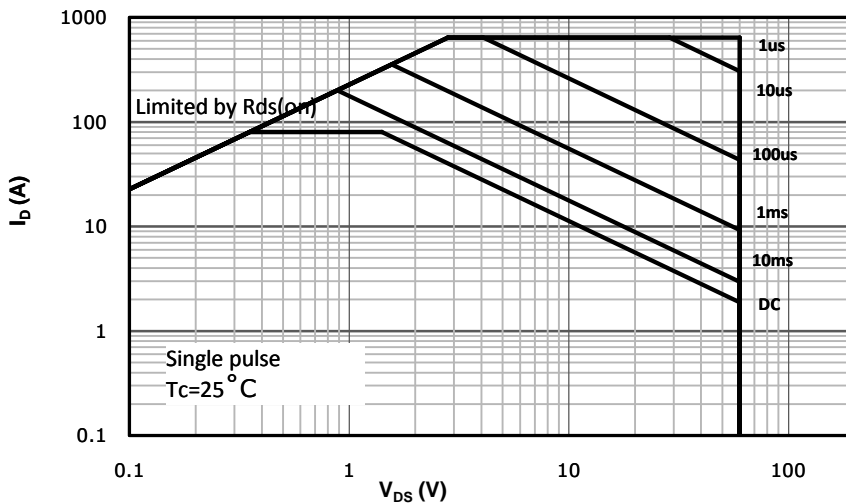
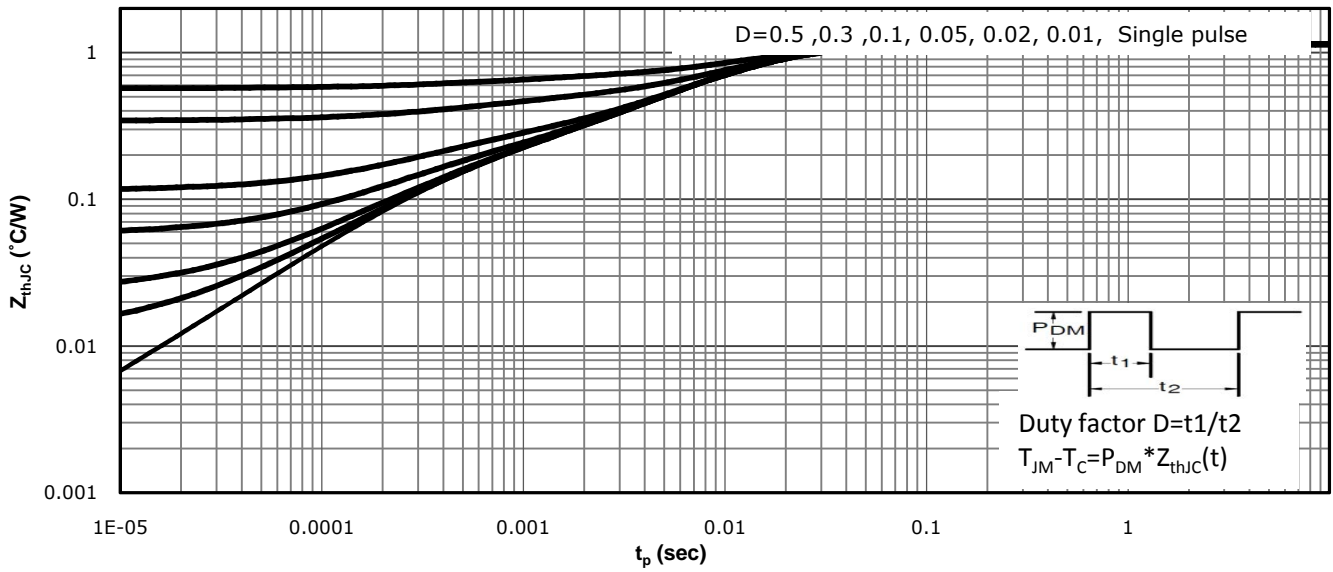

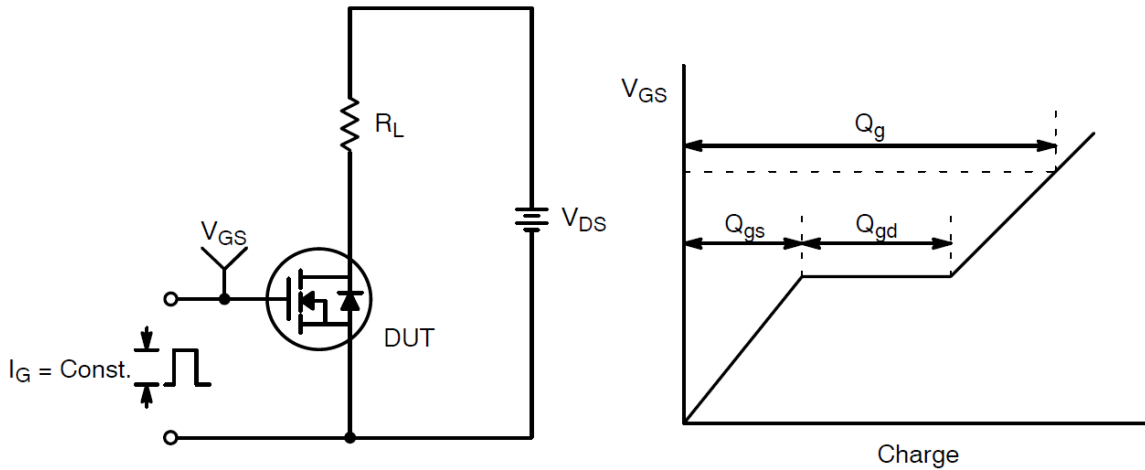

Fig 12: Max. Transient Thermal Impedance





### Test Circuit and Waveform:



Gate Charge Test Circuit & Waveform

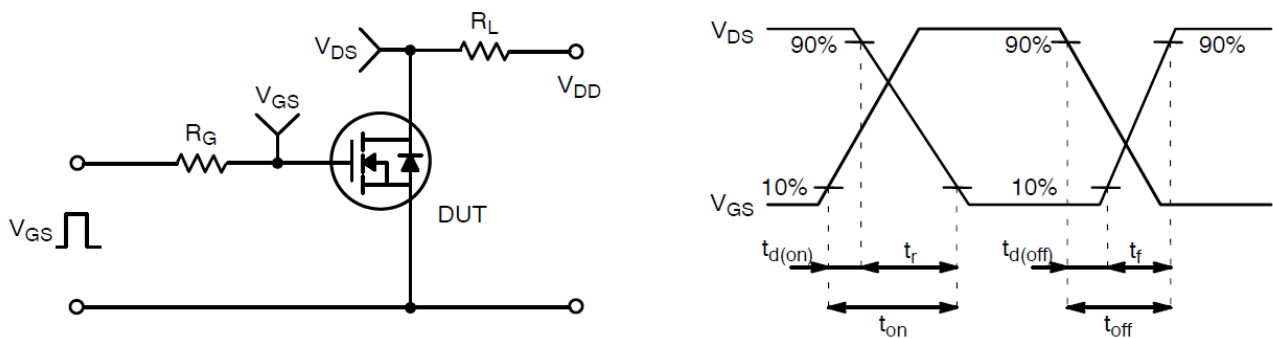

Resistive Switching Test Circuit & Waveforms

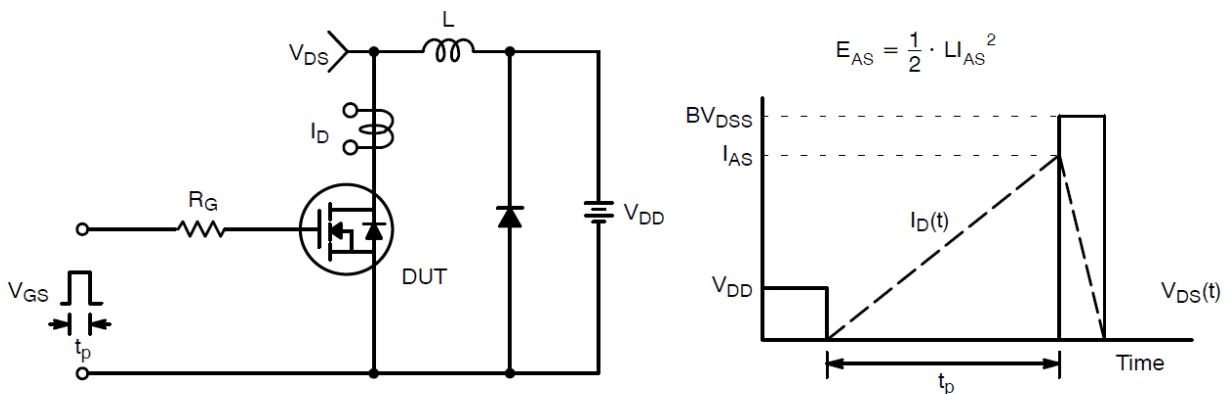

Unclamped Inductive Switching Test Circuit & Waveforms



**DFN5X6-8L Package Information**

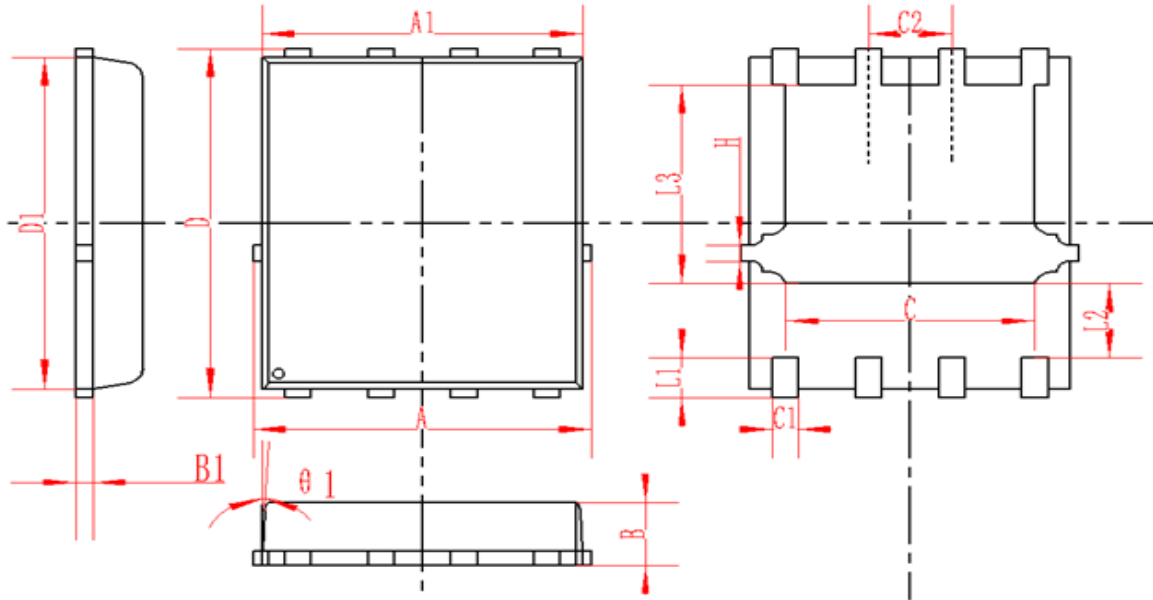

SYMBOL	MM			INCH		
	MIN	NOM	MAX	MIN	NOM	MAX
A	4.95	5	5.05	0.195	0.197	0.199
A1	4.82	4.9	4.98	0.190	0.193	0.196
D	5.98	6	6.02	0.235	0.236	0.237
D1	5.67	5.75	5.83	0.223	0.226	0.230
B	0.9	0.95	1	0.035	0.037	0.039
B1	0.254REF			0.010REF		
C	3.95	4	4.05	0.156	0.157	0.159
C1	0.35	0.4	0.45	0.014	0.016	0.018
C2	1.27TYP			0.5TYP		
θ1	8°	10°	12°	8°	10°	12°
L1	0.63	0.64	0.65	0.025	0.025	0.026
L2	1.2	1.3	1.4	0.047	0.051	0.055
L3	3.415	3.42	3.425	0.134	0.135	0.135
H	0.24	0.25	0.26	0.009	0.010	0.010



### Attention

- Any and all HUA XUAN YANG ELECTRONICS products described or contained herein do not have specifications that can handle applications that require extremely high levels of reliability, such as life-support systems, aircraft's control systems, or other applications whose failure can be reasonably expected to result in serious physical and/or material damage. Consult with your HUA XUAN YANG ELECTRONICS representative nearest you before using any HUA XUAN YANG ELECTRONICS products described or contained herein in such applications.
- HUA XUAN YANG ELECTRONICS assumes no responsibility for equipment failures that result from using products at values that exceed, even momentarily, rated values (such as maximum ratings, operating condition ranges, or other parameters) listed in products specifications of any and all HUA XUAN YANG ELECTRONICS products described or contained herein.
- Specifications of any and all HUA XUAN YANG ELECTRONICS products described or contained herein stipulate the performance, characteristics, and functions of the described products in the independent state, and are not guarantees of the performance, characteristics, and functions of the described products as mounted in the customer's products or equipment. To verify symptoms and states that cannot be evaluated in an independent device, the customer should always evaluate and test devices mounted in the customer's products or equipment.
- HUA XUAN YANG ELECTRONICS CO.,LTD. strives to supply high-quality high-reliability products. However, any and all semiconductor products fail with some probability. It is possible that these probabilistic failures could give rise to accidents or events that could endanger human lives, that could give rise to smoke or fire, or that could cause damage to other property. When designing equipment, adopt safety measures so that these kinds of accidents or events cannot occur. Such measures include but are not limited to protective circuits and error prevention circuits for safe design, redundant design, and structural design.
- In the event that any or all HUA XUAN YANG ELECTRONICS products(including technical data, services) described or contained herein are controlled under any of applicable local export control laws and regulations, such products must not be exported without obtaining the export license from the authorities concerned in accordance with the above law.
- No part of this publication may be reproduced or transmitted in any form or by any means, electronic or mechanical, including photocopying and recording, or any information storage or retrieval system, or otherwise, without the prior written permission of HUA XUAN YANG ELECTRONICS CO.,LTD.
- Information (including circuit diagrams and circuit parameters) herein is for example only ; it is not guaranteed for volume production. HUA XUAN YANG ELECTRONICS believes information herein is accurate and reliable, but no guarantees are made or implied regarding its use or any infringements of intellectual property rights or other rights of third parties.
- Any and all information described or contained herein are subject to change without notice due to product/technology improvement, etc. When designing equipment, refer to the "Delivery Specification" for the HUA XUAN YANG ELECTRONICS product that you intend to use.