



SOLID STATE INC.

46 FARRAND STREET
BLOOMFIELD, NEW JERSEY 07003

www.solidstateinc.com

**MUR2505
MUR2510
MUR2515
MUR2520**



SWITCHMODE POWER RECTIFIERS

... designed for use in switching power supplies, inverters and as free wheeling diodes, these state-of-the-art devices have the following features:

- Ultrafast 50 Nanosecond Recovery Time
- Low Forward Voltage Drop
- Hermetically Sealed Metal DO-203AA (DO-4) Package

**ULTRAFAST
RECTIFIERS**

**25 AMPERES
50 to 200 VOLTS**

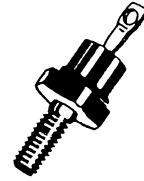

DO 4

MAXIMUM RATINGS

Rating	Symbol	MUR				Unit
		2505	2510	2515	2520	
Peak Repetitive Reverse Voltage Working Peak Reverse Voltage DC Blocking Voltage	V_{RRM} V_{RWM} V_R	50	100	150	200	Volts
Nonrepetitive Peak Reverse Voltage	V_{RSM}	55	110	165	220	Volts
Average Forward Current $T_C = 145^\circ\text{C}$	$I_{F(AV)}$	25				Amps
Nonrepetitive Peak Surge Forward Current (half cycle, 60 Hz, Sinusoidal Waveform)	I_{FSM}	500				Amps
Operating Junction and Storage Temperature	T_J, T_{stg}	-65 to +175				$^\circ\text{C}$

THERMAL CHARACTERISTICS

Rating	Symbol	All Devices	Unit
Thermal Resistance, Junction to Case	$R_{\theta JC}$	1.3	$^\circ\text{C}/\text{W}$

ELECTRICAL CHARACTERISTICS

Maximum Instantaneous Forward Voltage Drop ($i_F = 25 \text{ Amp}, T_J = 25^\circ\text{C}$) ($i_F = 25 \text{ Amp}, T_J = 125^\circ\text{C}$) ($i_F = 50 \text{ Amp}, T_J = 125^\circ\text{C}$)	v_F	0.95 0.80 0.88	Volts
Maximum Reverse Current @ DC Voltage ($T_J = 25^\circ\text{C}$) ($T_J = 125^\circ\text{C}$)	I_R	10 1.0	μA mA
Maximum Reverse Recovery Time ($I_F = 1.0 \text{ Amp}, di/dt = 50 \text{ Amp}/\mu\text{s}, V_R = 30 \text{ V}, T_J = 25^\circ\text{C}$)	t_{rr}	50	ns

MUR2505, MUR2510, MUR2515, MUR2520

FIGURE 1 — TYPICAL FORWARD VOLTAGE

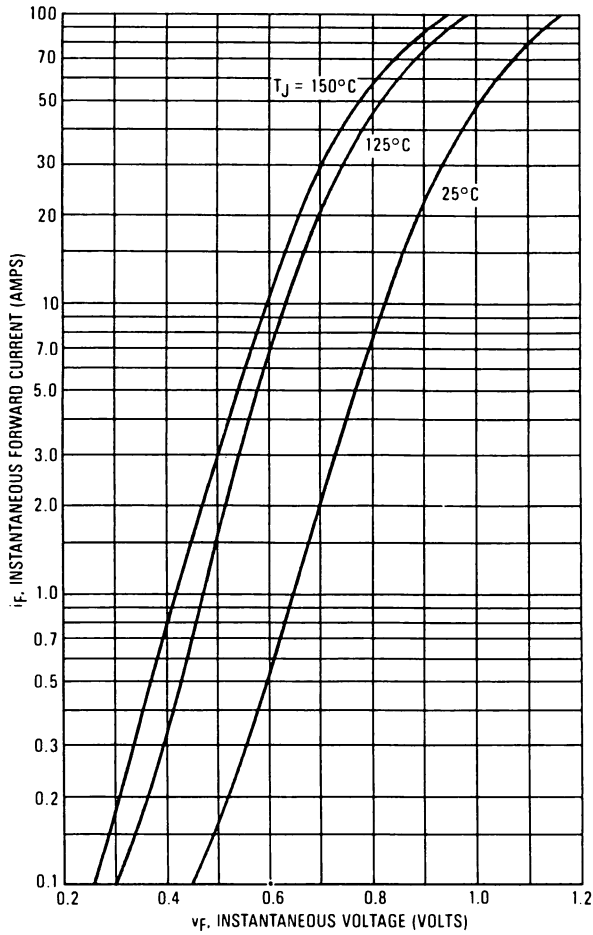
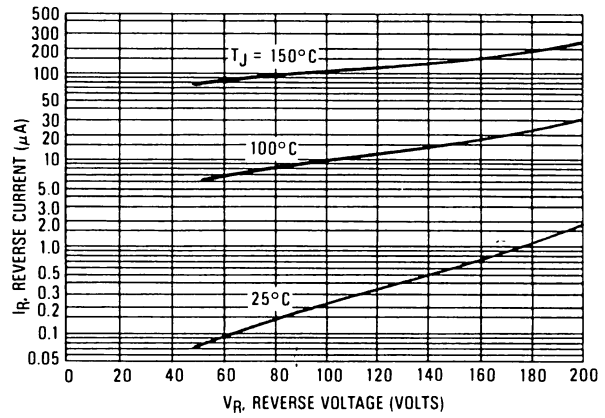

FIGURE 2 — TYPICAL REVERSE CURRENT*



*The curves shown are typical for the highest voltage device in the voltage grouping. Typical reverse current for lower voltage selections can be estimated from these same curves if V_R is sufficiently below rated V_R .

FIGURE 3 — CURRENT DERATING, CASE

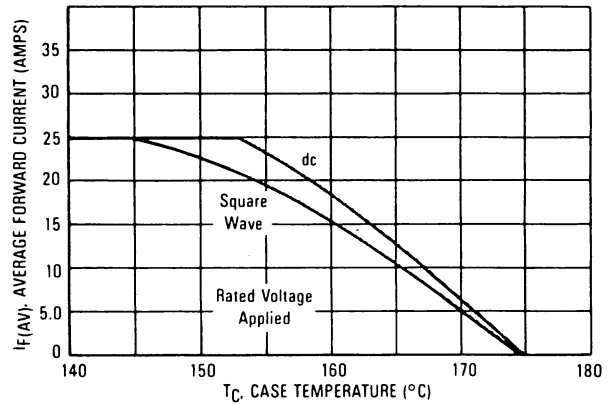

FIGURE 4 — POWER DISSIPATION

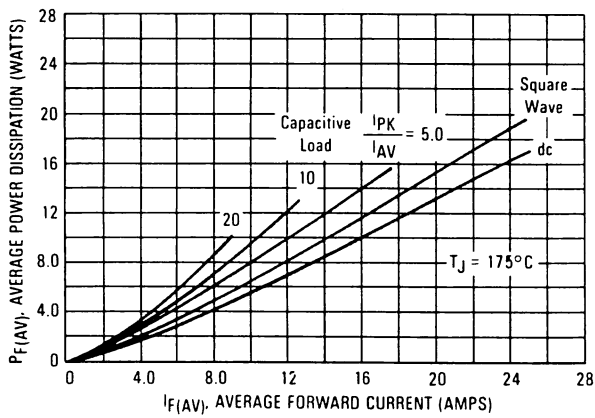

FIGURE 5 — TYPICAL CAPACITANCE

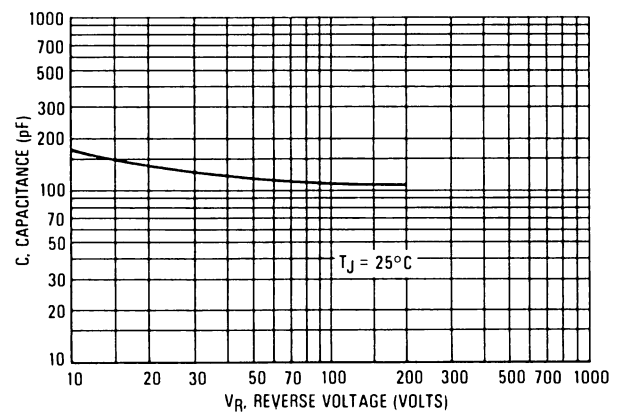
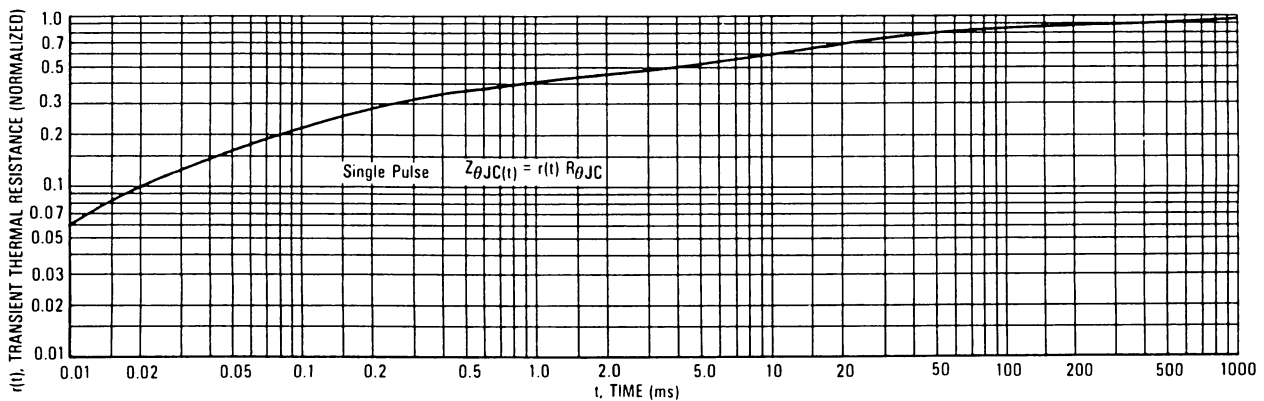

FIGURE 6 — THERMAL RESPONSE





SOLID STATE INC.

46 FARRAND STREET
BLOOMFIELD, NEW JERSEY 07003

www.solidstateinc.com

PACKAGE MECHANICAL DATA

DO 4 Metal

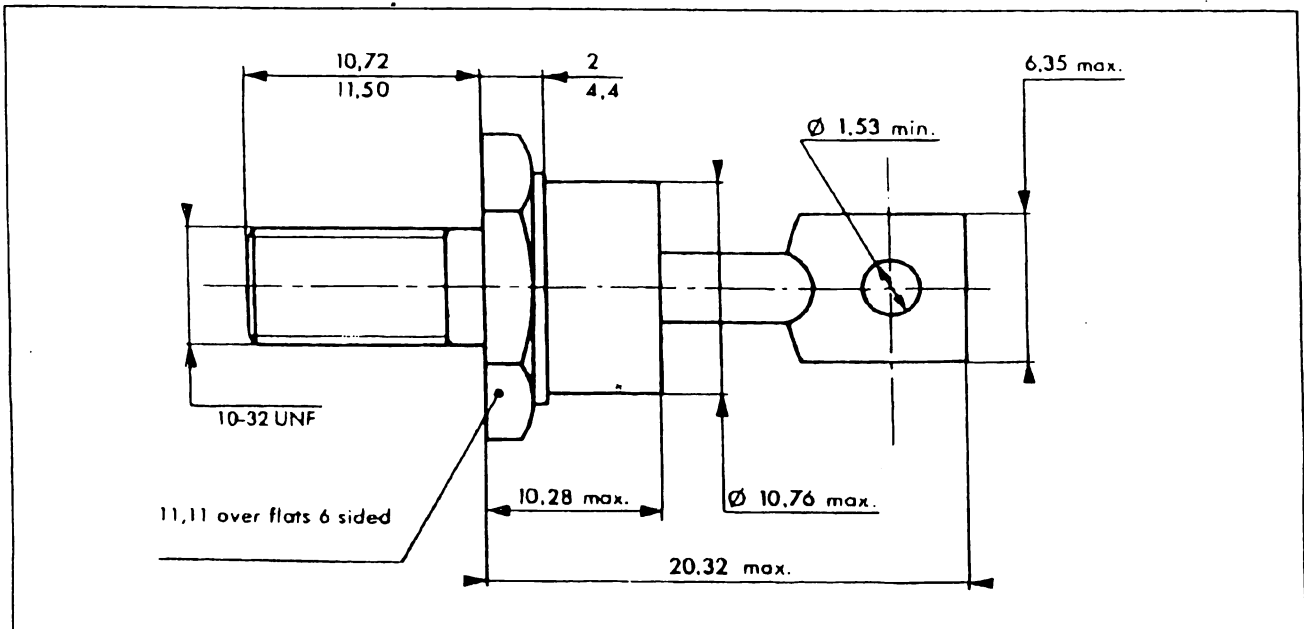

Marking : Cathode connected to case