

MFSA

SMD current sensing resistor-metal foil



Applications

- Switched-mode power supply (SMPS)
- Voltage regulator module
- Power management
- Stepper motor drives

Environmental compliance



Product features

- Low sensing resistance
- 0402 (1005 metric) to 1206 (3216 metric)
- High power dissipation
- AEC-Q200 compliant
- Moisture sensitivity level (MSL): 1

Table 1. Part numbering configuration scheme

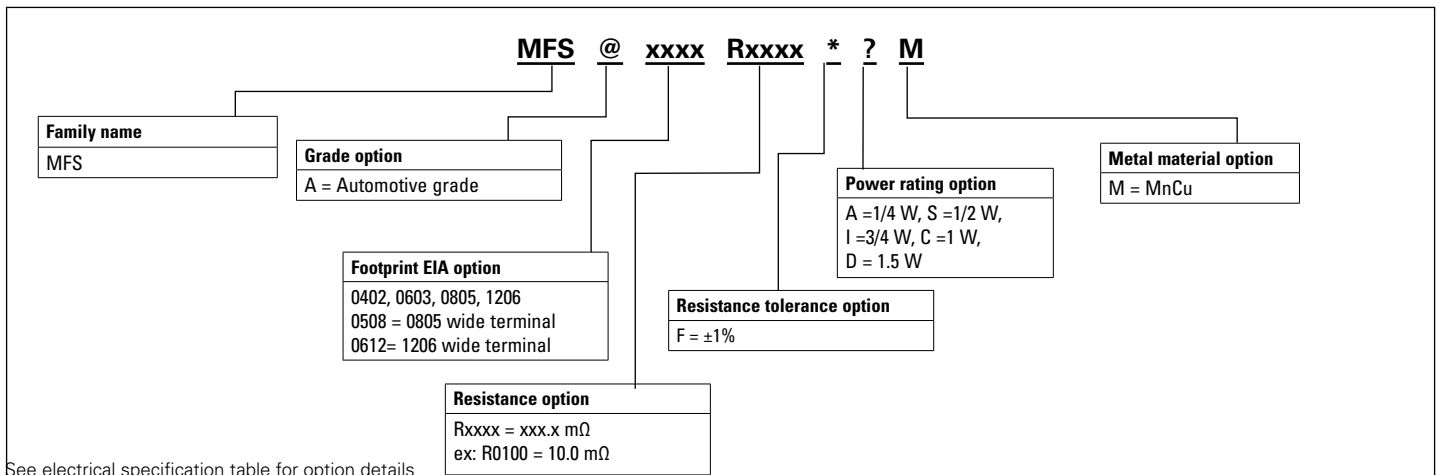

Mechanical parameters- Inches [mm]

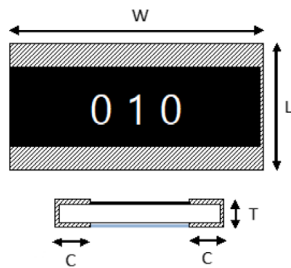
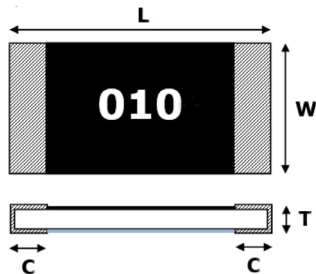

Construction

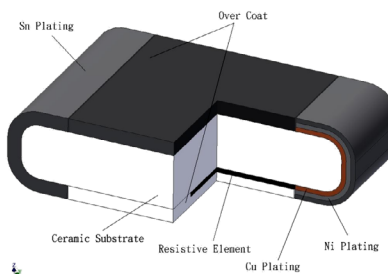
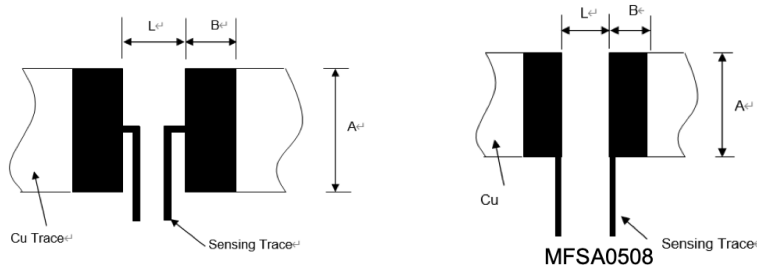

Figure A

Figure B

Family	Size code	L	W	C	T	Figure
MFSA0402	0402 [1005]	0.040 ± 0.004 [1.0 ± 0.10]	0.020 ± 0.004 [0.55 ± 0.10]	0.012 ± 0.004 [0.30 ± 0.10]	0.018 ± 0.004 [0.45 ± 0.10]	A
MFSA0603	0603 [1608]	0.063 ± 0.008 [1.60 ± 0.20]	0.031 ± 0.008 [0.80 ± 0.20]	0.016 ± 0.008 [0.40 ± 0.20]	0.028 ± 0.008 [0.70 ± 0.20]	A
MFSA0805	0805 [2012]	0.079 ± 0.008 [2.0 ± 0.20]	0.049 ± 0.008 [1.25 ± 0.20]	0.016 ± 0.012 [0.40 ± 0.30]	0.028 ± 0.008 [0.70 ± 0.20]	A
MFSA1206	1206 [3216]	0.126 ± 0.008 [3.20 ± 0.20]	0.063 ± 0.008 [1.60 ± 0.20]	0.020 ± 0.012 [0.50 ± 0.30]	0.028 ± 0.008 [0.70 ± 0.20]	A
MFSA0508	0508 [1220]	0.049 ± 0.008 [1.25 ± 0.20]	0.079 ± 0.008 [2.0 ± 0.20]	0.016 ± 0.008 [0.40 ± 0.20]	0.020 ± 0.008 [0.50 ± 0.20]	B
MFSA0612	0612 [1632]	0.063 ± 0.008 [1.60 ± 0.20]	0.126 ± 0.008 [3.20 ± 0.20]	0.016 ± 0.008 [0.40 ± 0.20]	0.020 ± 0.008 [0.50 ± 0.20]	B

Recommended PCB layout- mm



Family	Resistance (mΩ)	A	L	B
MFSA0402	10 ~ 20	0.7	0.45	0.375
MFSA0603	5 ≤ R ≤ 20	1	0.6	1.1
MFSA0805	5 ≤ R ≤ 30	1.4	1.2	1
MFSA1206	5 ≤ R ≤ 30	1.8	1.6	1.55
	31 ≤ R ≤ 40	1.8	2.2	1.35
MFSA0508	5 ≤ R ≤ 10	2.4	0.45	0.875
MFSA0612	1 ≤ R ≤ 20	3.8	0.85	0.625

Part marking

Family	Marking
MFSA0402	No marking
MFSA0603	No marking
MFSA0805	xxx: (xxx= resistance value in ohms expressed in 3 digits) 005 = 0.005 Ω or 5 mΩ
MFSA1206	010 = 0.010 Ω or 10 mΩ exception: 6.5 = 0.0065 Ω or 6.5 mΩ
MFSA0508	No marking
MFSA0612	xxx: (xxx= resistance value in ohms expressed in 3-4 digits) 0025 = 0.0025 Ω or 2.5 mΩ 005 = 0.005 Ω or 5 mΩ 010 = 0.010 Ω or 10 mΩ

1. The copper foil thickness of PCB needs 3 oz. minimum
2. PCB layout dimension tolerance is +/-0.1 mm.
3. The Resistance will change slightly after soldered; it is dependent on PCB pad size design and it's necessary to consider the effect of the resistance increase or decrease.

Electrical specifications

Part number	Size	Grade option	Resistance value mΩ (Part number code)	Resistance tolerance (Part number code)	Power rating (Part number code)	TCR (ppm/°C)	Operating temperature
MFS@0402Rxxxx*?M	0402 (1005 metric)	A	10 (0100)	±1% (F)	1/4 W (A)	± 100	-55 °C to +125 °C
MFS@0402Rxxxx*?M	0402 (1005 metric)	A	20 (0200)	±1% (F)	1/4 W (A)	± 100	-55 °C to +125 °C
MFS@0603Rxxxx*?M	0603 (1608 metric)	A	5 (0050)	±1% (F)	1/2 W (S)	± 50	-55 °C to +155 °C
MFS@0603Rxxxx*?M	0603 (1608 metric)	A	7 (0070)	±1% (F)	1/2 W (S)	± 50	-55 °C to +155 °C
MFS@0603Rxxxx*?M	0603 (1608 metric)	A	9 (0090)	±1% (F)	1/2 W (S)	± 50	-55 °C to +155 °C
MFS@0603Rxxxx*?M	0603 (1608 metric)	A	10 (0100)	±1% (F)	1/2 W (S)	± 50	-55 °C to +155 °C
MFS@0603Rxxxx*?M	0603 (1608 metric)	A	15 (0150)	±1% (F)	1/2 W (S)	± 50	-55 °C to +155 °C
MFS@0603Rxxxx*?M	0603 (1608 metric)	A	20 (0200)	±1% (F)	1/2 W (S)	± 50	-55 °C to +155 °C
MFS@0805Rxxxx*?M	0805 (2012 metric)	A	5(0050)	±1% (F)	3/4 W (I)	± 50	-55 °C to +155 °C
MFS@0805Rxxxx*?M	0805 (2012 metric)	A	6 (0060)	±1% (F)	3/4 W (I)	± 50	-55 °C to +155 °C
MFS@0805Rxxxx*?M	0805 (2012 metric)	A	6.5 (0065)	±1% (F)	3/4 W (I)	± 50	-55 °C to +155 °C
MFS@0805Rxxxx*?M	0805 (2012 metric)	A	7 (0070)	±1% (F)	3/4 W (I)	± 50	-55 °C to +155 °C
MFS@0805Rxxxx*?M	0805 (2012 metric)	A	8 (0080)	±1% (F)	3/4 W (I)	± 50	-55 °C to +155 °C
MFS@0805Rxxxx*?M	0805 (2012 metric)	A	9 (0090)	±1% (F)	3/4 W (I)	± 50	-55 °C to +155 °C
MFS@0805Rxxxx*?M	0805 (2012 metric)	A	10 (0100)	±1% (F)	3/4 W (I)	± 50	-55 °C to +155 °C
MFS@0805Rxxxx*?M	0805 (2012 metric)	A	15 (0150)	±1% (F)	3/4 W (I)	± 50	-55 °C to +155 °C
MFS@0805Rxxxx*?M	0805 (2012 metric)	A	20 (0200)	±1% (F)	3/4 W (I)	± 50	-55 °C to +155 °C
MFS@0805Rxxxx*?M	0805 (2012 metric)	A	25 (0250)	±1% (F)	3/4 W (I)	± 50	-55 °C to +155 °C
MFS@0805Rxxxx*?M	0805 (2012 metric)	A	30 (0300)	±1% (F)	3/4 W (I)	± 50	-55 °C to +155 °C
MFS@1206Rxxxx*?M	1206 (3216 metric)	A	5 (0050)	±1% (F)	1 W (C)	± 50	-55 °C to +155 °C
MFS@1206Rxxxx*?M	1206 (3216 metric)	A	6 (0060)	±1% (F)	1 W (C)	± 50	-55 °C to +155 °C
MFS@1206Rxxxx*?M	1206 (3216 metric)	A	8 (0080)	±1% (F)	1 W (C)	± 50	-55 °C to +155 °C
MFS@1206Rxxxx*?M	1206 (3216 metric)	A	10 (0100)	±1% (F)	1 W (C)	± 50	-55 °C to +155 °C
MFS@1206Rxxxx*?M	1206 (3216 metric)	A	11 (0110)	±1% (F)	1 W (C)	± 50	-55 °C to +155 °C
MFS@1206Rxxxx*?M	1206 (3216 metric)	A	12 (0120)	±1% (F)	1 W (C)	± 50	-55 °C to +155 °C
MFS@1206Rxxxx*?M	1206 (3216 metric)	A	15 (0150)	±1% (F)	1 W (C)	± 50	-55 °C to +155 °C
MFS@1206Rxxxx*?M	1206 (3216 metric)	A	17 (0170)	±1% (F)	1 W (C)	± 50	-55 °C to +155 °C
MFS@1206Rxxxx*?M	1206 (3216 metric)	A	18 (0180)	±1% (F)	1 W (C)	± 50	-55 °C to +155 °C
MFS@1206Rxxxx*?M	1206 (3216 metric)	A	20 (0200)	±1% (F)	1 W (C)	± 50	-55 °C to +155 °C
MFS@1206Rxxxx*?M	1206 (3216 metric)	A	22 (0220)	±1% (F)	1 W (C)	± 50	-55 °C to +155 °C
MFS@1206Rxxxx*?M	1206 (3216 metric)	A	25 (0250)	±1% (F)	1 W (C)	± 50	-55 °C to +155 °C
MFS@1206Rxxxx*?M	1206 (3216 metric)	A	27 (0270)	±1% (F)	1 W (C)	± 50	-55 °C to +155 °C
MFS@1206Rxxxx*?M	1206 (3216 metric)	A	30 (0300)	±1% (F)	1 W (C)	± 50	-55 °C to +155 °C
MFS@1206Rxxxx*?M	1206 (3216 metric)	A	33 (0330)	±1% (F)	1 W (C)	± 50	-55 °C to +155 °C
MFS@1206Rxxxx*?M	1206 (3216 metric)	A	40 (0400)	±1% (F)	1 W (C)	± 50	-55 °C to +155 °C

@= Enter grade option code from table above (A=Automotive)
Rxxxx = Enter resistance code option from table above xxx= resistance code (xxx.x mΩ ex: R0100 = 10.0 mΩ)
*= Enter resistance tolerance code option from table above (F= ±1%)
?= Enter power rating code option from table above (A =1/4 W, S =1/2 W, I =3/4 W, C=1 W, D = 1.5 W)
M=MnCu (Metal material)

Electrical specifications

Part number	Size	Grade option	Resistance value mΩ (Part number code)	Resistance tolerance (Part number code)	Power rating (Part number code)	TCR (ppm/°C)	Operating temperature
MFS@0508Rxxxx*?M	0508 (1220 metric)	A	5 (0050)	±1% (F)	1 W (C)	± 50	-55 °C to +155 °C
MFS@0508Rxxxx*?M	0508 (1220 metric)	A	10 (0100)	±1% (F)	1 W (C)	± 50	-55 °C to +155 °C
MFS@0612Rxxxx*?M	0612 (1632 metric)	A	2 (0020)	±1% (F)	1.5 W (D)	± 75	-55 °C to +155 °C
MFS@0612Rxxxx*?M	0612 (1632 metric)	A	3 (0030)	±1% (F)	1.5 W (D)	± 75	-55 °C to +155 °C
MFS@0612Rxxxx*?M	0612 (1632 metric)	A	4 (0040)	±1% (F)	1.5 W (D)	± 75	-55 °C to +155 °C
MFS@0612Rxxxx*?M	0612 (1632 metric)	A	5 (0050)	±1% (F)	1.5 W (D)	± 50	-55 °C to +155 °C
MFS@0612Rxxxx*?M	0612 (1632 metric)	A	6 (0060)	±1% (F)	1.5 W (D)	± 50	-55 °C to +155 °C
MFS@0612Rxxxx*?M	0612 (1632 metric)	A	6.5 (0065)	±1% (F)	1.5 W (D)	± 50	-55 °C to +155 °C
MFS@0612Rxxxx*?M	0612 (1632 metric)	A	7 (0070)	±1% (F)	1.5 W (D)	± 50	-55 °C to +155 °C
MFS@0612Rxxxx*?M	0612 (1632 metric)	A	8 (0080)	±1% (F)	1.5 W (D)	± 50	-55 °C to +155 °C
MFS@0612Rxxxx*?M	0612 (1632 metric)	A	9 (0090)	±1% (F)	1.5 W (D)	± 50	-55 °C to +155 °C
MFS@0612Rxxxx*?M	0612 (1632 metric)	A	10 (0100)	±1% (F)	1.5 W (D)	± 50	-55 °C to +155 °C

@= Enter grade option code from table above (A=Automotive)

Rxxxx = Enter resistance code option from table above xxxx= resistance code (xxx.x mΩ ex: R0100 = 10.0 mΩ)

*= Enter resistance tolerance code option from table above (F= ±1%)

?= Enter power rating code option from table above (A =1/4 W, S =1/2 W, I =3/4 W, C =1 W, D = 1.5 W)

M=MnCu (Metal material)

Packaging information- mm

Supplied in tape and reel on a 7.0" diameter reel (EIA-481 compliant)

Size	Tape	Quantity
0402	7 inch paper	10K
0603	7 inch paper	5K
0805	7 inch paper	4K
1206	7 inch paper	4K
0508	7 inch paper	4K
0612	7 inch paper	4K

Tape carrier and dimensions

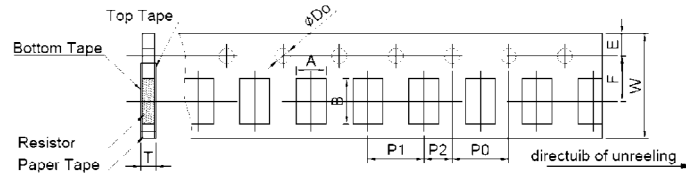

Dimension	0402	0603	0805	1206	0508	0612
E1	1.75 ± 0.1	1.75 ± 0.1	1.75 ± 0.1	1.75 ± 0.1	1.75 ± 0.1	1.75 ± 0.1
F	3.5 ± 0.05	3.5 ± 0.05	3.5 ± 0.05	3.5 ± 0.05	3.5 ± 0.05	3.5 ± 0.05
P2	2.0 ± 0.1	2.0 ± 0.1	2.0 ± 0.1	2.0 ± 0.1	2.0 ± 0.1	2.0 ± 0.1
D0	1.5 ± 0.1	1.5 ± 0.1	1.5 ± 0.1	1.5 ± 0.1	1.5 ± 0.1	1.5 ± 0.1
P0	4.0 ± 0.1	4.0 ± 0.1	4.0 ± 0.1	4.0 ± 0.1	4.0 ± 0.1	4.0 ± 0.1
W	8.0 ± 0.2	8.0 ± 0.2	8.0 ± 0.2	8.0 ± 0.2	8.0 ± 0.2	8.0 ± 0.2
P1	4.0 ± 0.1	4.0 ± 0.1	4.0 ± 0.1	4.0 ± 0.1	4.0 ± 0.1	4.0 ± 0.1
A0	0.75 ± 0.05	1.1 ± 0.15	1.6 ± 0.15	2.0 ± 0.15	1.6 ± 0.15	2.0 ± 0.15
B0	1.3 ± 0.05	1.9 ± 0.2	2.4 ± 0.2	3.6 ± 0.2	2.4 ± 0.2	3.6 ± 0.2
T	0.65 ± 0.1	0.85 ± 0.1	1.05 ± 0.1	1.05 ± 0.1	1.05 ± 0.1	1.05 ± 0.1

Reel dimensions

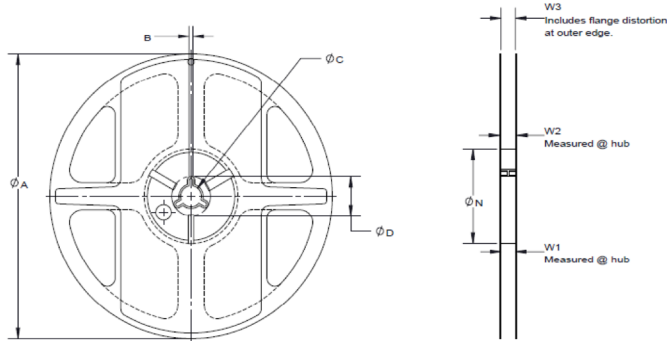

Size	A	B	C	D	N	W1	W2	W3
0402	178 ± 2.0	3.5 ± 0.5	13.0 ± 1.0	na	60 ± 1.0	9.0 ± 1.0	11.4 ± 1.0	na
0603	178 ± 2.0	3.5 ± 0.5	13.0 ± 1.0	na	60 ± 1.0	9.0 ± 1.0	11.4 ± 1.0	na
0805	178 ± 2.0	3.5 ± 0.5	13.0 ± 1.0	na	60 ± 1.0	9.0 ± 1.0	11.4 ± 1.0	na
1206	178 ± 2.0	3.5 ± 0.5	13.0 ± 1.0	na	60 ± 1.0	9.0 ± 1.0	11.4 ± 1.0	na
0508	178 ± 2.0	3.5 ± 0.5	13.0 ± 1.0	na	60 ± 1.0	9.0 ± 1.0	11.4 ± 1.0	na
0612	178 ± 2.0	3.5 ± 0.5	13.0 ± 1.0	na	60 ± 1.0	9.0 ± 1.0	11.4 ± 1.0	na

General specifications

Insulation resistance: > 100 MΩ

Temperature coefficient of resistance: IEC60115-1 4.8, +25 °C to +125 °C

Short time overload: IEC60115-1 4.13, 5 X rated power for 5 s

High temperature exposure (storage): AEC-Q200-REV D-test 3, MIL-STD202 Method 108, 1000 hours. @ Tup, Max operation temperature

Temperature cycling: AEC-Q200-REV D-Test 4, JESD22 Method JA-104, 1000 cycles (-55 °C to +125 °C), 30 minute maximum dwell time at each temperature extreme. 1 minute maximum transition time.

Moisture resistance: AEC-Q200-REV D-Test 6 , MIL-STD-202 method 106, 24 hours per cycle, 10 cycles, Notes: Steps 7a& 7b not required. Unpowered

Biased humidity: AEC-Q200-REV D-Test 7, MIL-STD-202 method 103, 1000 hours +85 °C/85% RH. Note: Specified conditions: 10% of operating power (not exceeding max working voltage).

Operational life: AEC-Q200-REV D-Test 8, MIL-STD-202 method 108, 1000 hours, +125 °C at 35% rated power.

Resistance to solvents: AEC-Q200-REV D-Test 12, MIL-STD-202 method 215, a: Isopropyl alcohol : mineral spirits= 1 : 3, b: Terpene defluxer (Bioact EC-7R) c: Deionized water : Propylene glycol Monomethyl ether : monoethanolamine = 42 : 1

Mechanical shock: AEC-Q200-REV D-Test 13, MIL-STD-202 Method 213, half sine shock pulse, peak value is 100 g's. Normal duration (D) is 6 (ms),

Vibration: AEC-Q200-REV D-Test 14, MIL-STD-202 method 204, 5 g's for 20 minutes, 12 cycles each of 3 orientations. Test from 10-2000 Hz

Resistance to soldering heat: AEC-Q200-REV D-Test 15, MIL-STD-202 method 210, Condition B : Immerse in eutectic solder at +260 °C ± 5 °C for 10 ± 1 second

Thermal shock: AEC-Q200-REV D-Test 16, MIL-STD-202 method 107, -55 °C/+155 °C. 300 cycles, Maximum transfer time 20 seconds, Dwell time 15 minutes. Air-Air

ESD: AEC-Q200-REV D-Test 17, AEC-Q200-002 or ISO/DIS 10605, verify the voltage setting at 500 V

Solderability: AEC-Q200-REV D-Test 18, J-STD-002, method B, aging 4 hours at +155 °C dry heat Lead-free solder bath at +235 °C ± 3 °C, Dipping time: 3 ± 0.5 seconds, > 95% area covered with tin

Flammability: AEC-Q200-REV D-Test 20, UL-94, V-0 or V-1 are acceptable.

Board flex (bending): AEC-Q200-REV D-Test 21, AEC-Q200-005, The duration of the applied forces shall be 60 (+ 5) seconds, 2 mm deflection

Terminal strength (SMD): AEC-Q200-REV D-Test 22, AEC-Q200-006, Force of 1.8 kg for 60 seconds

Temperature derating curve

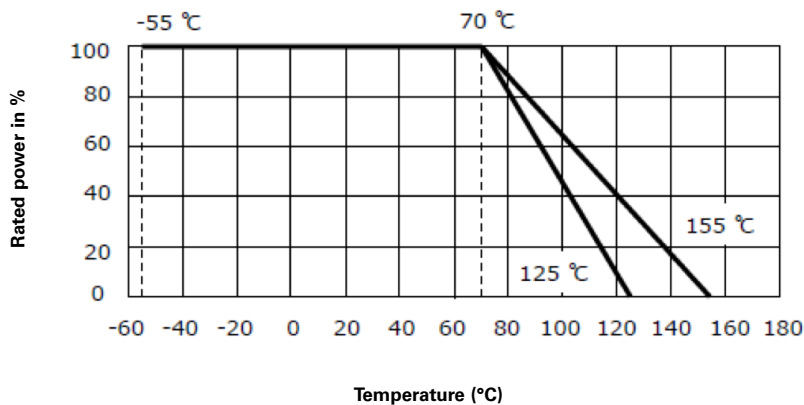

Rated current & voltage

The rated Current and Voltage are calculated by the following formula:

$$I = \sqrt{P \div R}$$

$$V = \sqrt{P \times R}$$

I: Rated current (A)

V: Rated voltage (V)

P: Rated power (W)

R: Resistance value (Ω)

Solder reflow profile

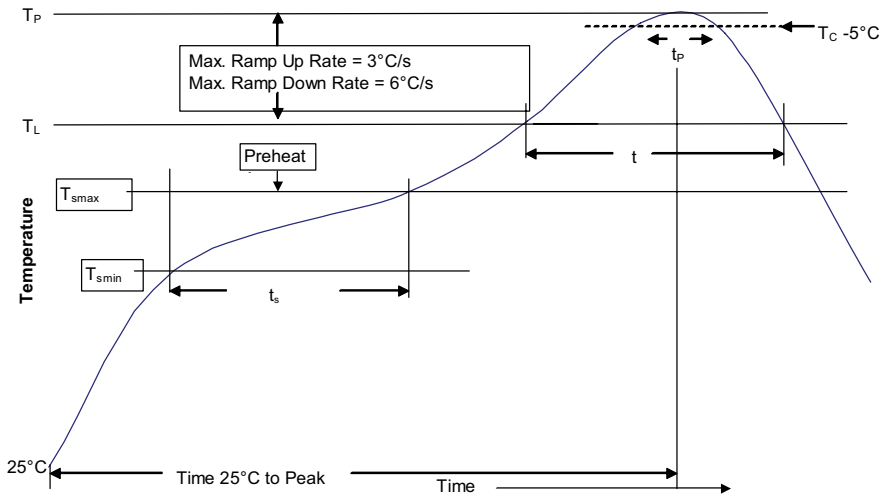

Profile feature	Lead (Pb) free solder	
Preheat and soak	<ul style="list-style-type: none"> • Temperature min. (T_{smin}) • Temperature max. (T_{smax}) • Time (T_{smin} to T_{smax}) (t_s) 	150 °C 200 °C 60-150 seconds
Ramp up rate T_L to T_p	3 °C/ second max.	
Liquidous temperature (T_L) Time (t_L) maintained above T_L	217 °C 60-120 seconds	
Peak package body temperature (T_p)*	260 °C	
Time (t_p)* within 5 °C of the specified classification temperature (T_c)	10 seconds*	
Ramp-down rate (T_p to T_L)	6 °C/ second max.	
Time 25 °C to peak temperature	8 minutes max.	

* Tolerance for peak profile temperature (T_p) is defined as a supplier minimum and a user maximum.

Manual solder

+350 °C ±10 °C , 3 +1/-0 seconds 1 time (by soldering iron), generally manual, hand soldering is not recommended

Life Support Policy: Eaton does not authorize the use of any of its products for use in life support devices or systems without the express written approval of an officer of the Company. Life support systems are devices which support or sustain life, and whose failure to perform, when properly used in accordance with instructions for use provided in the labeling, can be reasonably expected to result in significant injury to the user.

Eaton reserves the right, without notice, to change design or construction of any products and to discontinue or limit distribution of any products. Eaton also reserves the right to change or update, without notice, any technical information contained in this bulletin.

Eaton
Electronics Division
 1000 Eaton Boulevard
 Cleveland, OH 44122
 United States
 Eaton.com/electronics

© 2022 Eaton
 All Rights Reserved
 Printed in USA
 Publication No. ELX1180 BU-ELX22040
 June 2022

Eaton is a registered trademark.

All other trademarks are property of their respective owners.

Follow us on social media to get the latest product and support information.

