

1. 产品描述/ Features

- 外观尺寸/ Package (L/W/H): 1.1*0.5*0.4 mm
- 颜色/ Color: 黄绿光 / Green-yellow light
- 胶体/ Lens: 透明平面胶体/ Transparent planar colloid
- EIA规范标准包装/ EIA STD Package
- 环保产品, 符合ROHS要求/ Meet ROHS, Green Product
- 适用于自动贴片机/ Compatible With SMT Automatic Equipment
- 适用于红外线回流焊制程/ Compatible With Infrared Reflow Solder Process

2. 外形尺寸及建议焊盘尺寸/ Package Profile & Soldering PAD Suggested

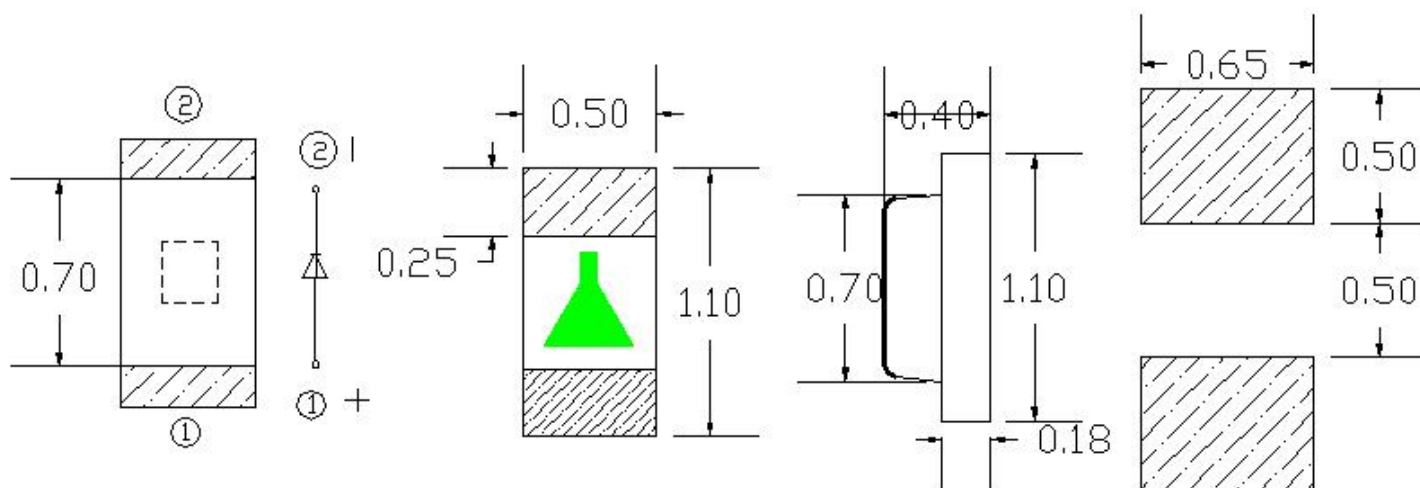

注/ Notes: 1. 单位 : 毫米 (mm) / All dimensions are in millimeters

2. 公差 : 如无特别标注则为 ± 0.1 mm Tolerance is ± 0.10 mm unless otherwise noted

3. 建议焊接温度曲线 / Soldering Profile Suggested

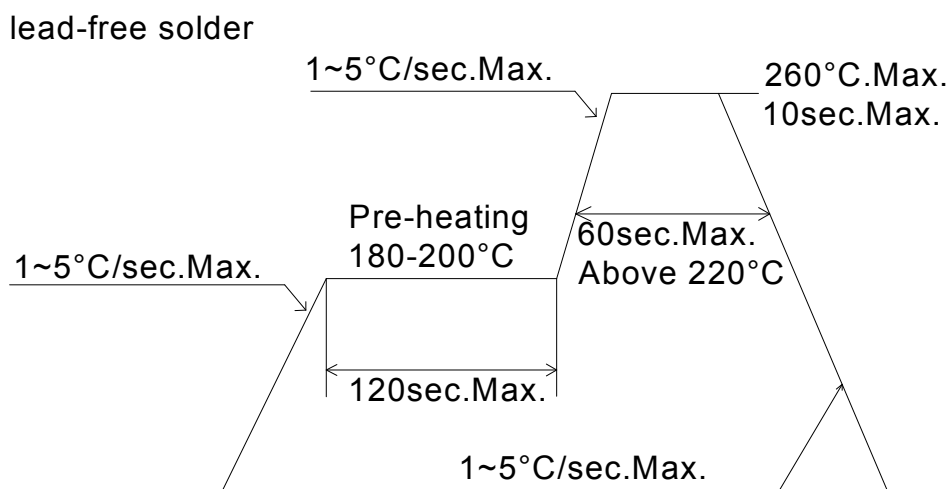

4. 最大绝对额定值/ Absolute Maximum Ratings (Ta=25°C)

参数/ Parameter	符号Symbol	最大额定值/ Rating	单位/ Unit
消耗功率/ Power Dissipation	Pd	60	mW
最大脉冲电流/ Peak Forward Current (1/10占空比, 0.1ms脉宽)	IFP	60	mA
正向直流工作电流/ DC Forward Current	IF	20	mA
工作温度范围 Operating Temperature Range	Topr	-40°C ~ +85°C	
存储温度范围 Storage Temperature Range	Tstg	-40°C ~ +85°C	
焊接条件 Soldering Condition	Tsol	回流焊/ Reflow soldering : 260°C , 10s 手动焊/ Hand soldering : 300°C , 3s	
抗静电能力 Electrostatic Discharge	ESD		V

5. 光电参数/ Electrical Optical Characteristics (Ta=25°C)

参数 Parameter	符号 Symbol	最小值 Min.	代表值 Typ.	最大值 Max.	单位 Unit	测试条件 Test Condition
光强 Light Intensity	IV	24	--	85	mcd	IF = 20mA
半光强视角 Viewing Angle	2θ1/2	---	120	---	deg	IF = 20mA
主波长 Dominant Wavelength	λd	568		576	nm	IF = 20mA
峰值波长 Peak Wavelength	λp		578		nm	IF = 20mA
正向电压 Forward Voltage	VF	1.8		2.4	V	IF = 20mA
反向电流 Reverse current	IR	Not designed for reverse operation 未设计反向应用			μA	VR = 5V
半波宽 Spectral Line Half-Width	Δλ		20		nm	IF = 20mA

Note 备注: VR=5V For test conditions , VR=5V 为测试分选条件

6. 光电参数代表值特征曲线/ Typical Electrical-Optical Characteristics Curves

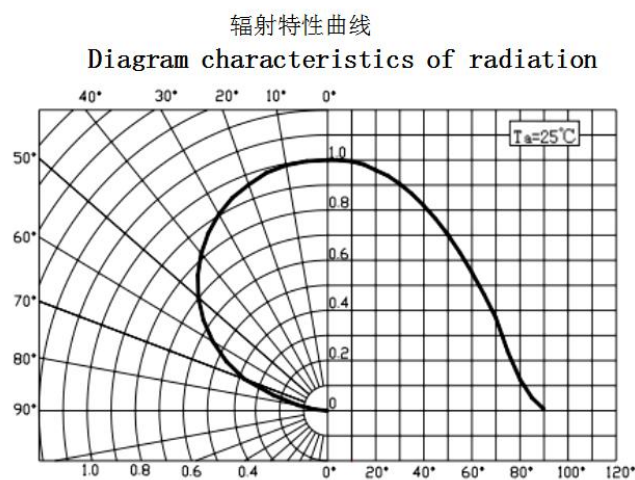
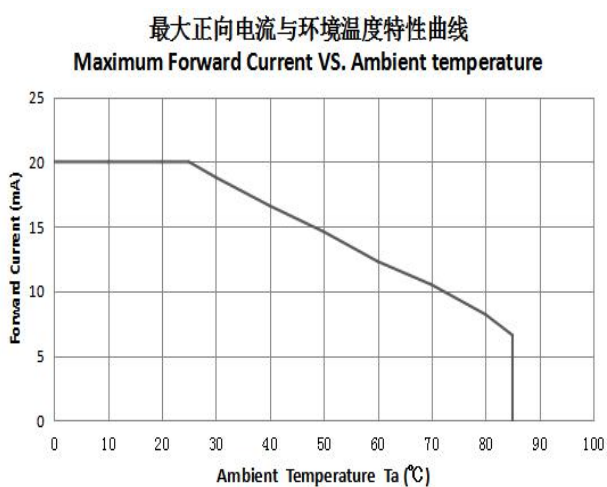
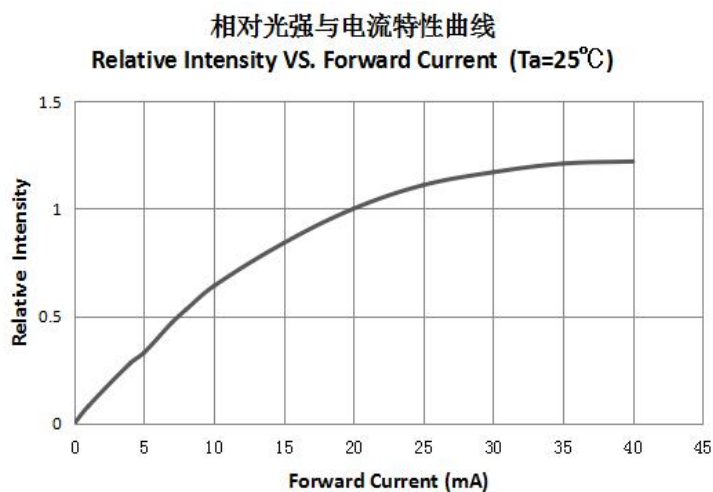
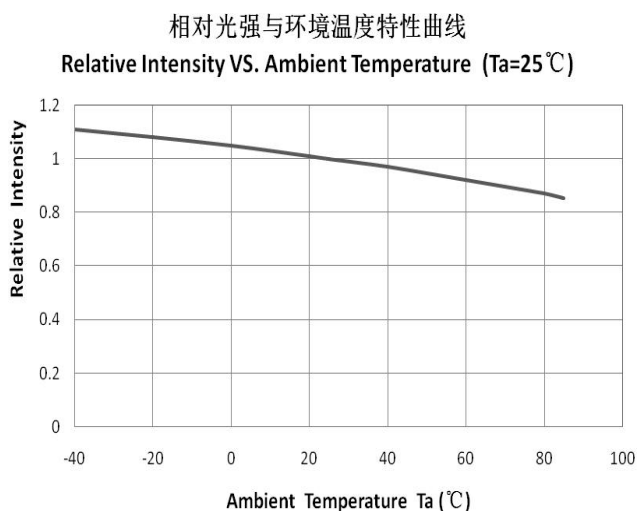
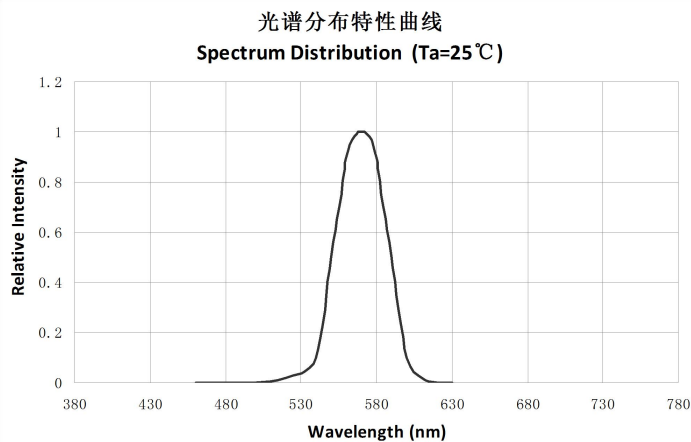
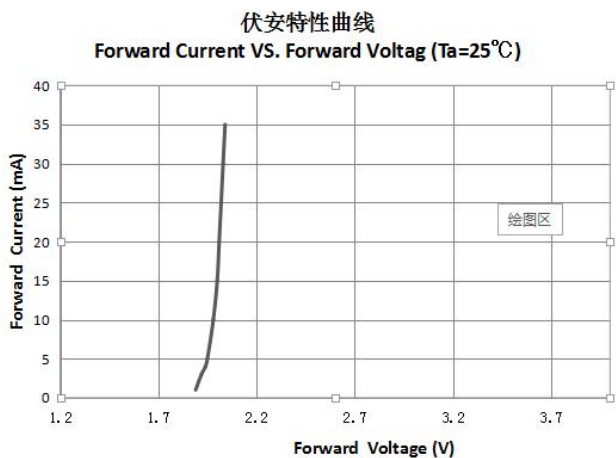

7. 信赖性测试项目及条件/Reliability Test Items And Conditions

测试项目 Test Item	Ref. Standard 参考标准	Test Condition 测试条件	Time 时间	Quantity 数量	Accepted/Rejected 接收/拒收
Reflow 回流焊	JESD22-B106	Temp:255°Cmax T=10 sec	1times	22	0/1
Thermal Shock 冷热冲击	JESD22-A106	-40°C 30min ↑ ↓ 100°C 30min	100 cycles	22	0/1
High Temperature Storage 高温保存	JESD22-A103	Temp:100°C	168Hrs.	22	0/1
Low Temperature Storage 低温保存	JESD22-A119	Temp:-40°C	168Hrs.	22	0/1
Life Test 常温通电	JESD22-A108	Ta=25°C IF=20mA	168Hrs.	22	0/1
High Temperature / High Humidity 高温高湿	Qiangsq831	85°C / 85%RH	168Hrs.	22	0/1

失效判定标准 Criteria For Judging Damage

Test Items 项目	Symbol 符号	Test Condition 测试条件	Judging For Damage 判定标准	
			Min. 最小	Max. 最大
Forward Voltage 正向电压	VF	IF=20mA	-	U.S.L*)x1.1
Reverse Current 漏电流	IR	VR = 5V	-	U.S.L*)x2.0
光强 Luminous Intensity	Mcd	IF=20mA	L.S.L*)x0.7	

U. S. L: Upper standard level 规格上限

L. S. L: Lower standard level 规格下限

8. 注意事项/ Cautions:

8.1. 焊接/welding

8.1.1 SMD LED 灌封胶较软，外力易损坏发光面及塑料壳，焊接时要轻拿轻放。

SMD LED is soft and easy to damage the luminous surface and plastic shell by external force. It should be handled lightly when welding

8.1.2 建议使用易洗型的助焊剂，依照回流曲线条件回流焊接，回流次数最多两次，确保 LED 发光面干净，异物会影响发光颜色。

It is recommended to use soldering flux with tin wash type, reflow soldering according to the condition of reflux curve, reflow twice at most, ensure the LED luminous surface is clean, foreign matter will affect the luminous color.

8.1.3 只建议在修理和重工的情况下使用手工焊接；最高焊接温度不应超过 300 度，且须在 3 秒内完成（手工焊接只可焊接一次）烙铁最大功率应不超过 25W。

Manual welding is only recommended for repair and heavy industry;The maximum welding temperature should not exceed 300 degrees, and must be completed within 3 seconds (manual welding can only be welded once) soldering iron maximum power should not exceed 25W.

8.1.4 焊接过程中，严禁在高温情况下碰触胶体；焊接后，禁止对胶体施加外力，禁止弯折 PCB，避免元件受到撞击。

During the soldering process, do not touch the lens at high temperature, After soldering, any mechanical force on the lens or any excessive vibration shall not be accepted to apply, also the circuit board shall not be bent as well.

8.1.5 请不要将不同 BIN 级的 LED 使用于同一个产品上，否则可能会导致产品的严重色差。

Please do not use different BIN LED on the same product, otherwise it may cause serious color difference.

8.2. 清洗/cleaning

8.2.1 不能用超声波清洗，建议使用异丙醇（isopropyl alcohol）、纯酒精擦拭或浸渍（浸渍不超过 1 分钟）在室温下放置 15 分钟再使用；清洗后，确保 LED 发光面干净，异物会影响发光颜色。

/No ultrasonic cleaning. It is recommended to use isopropyl alcohol, pure alcohol to wipe or soak, not more than 1 minute, and leave at room temperature for 15 minutes before use. After cleaning, make sure the LED luminous surface is clean and the foreign matter will affect the luminous color.

8.2.2 应避免接触或污染天那水，三氯乙烯、丙酮、硫化物、氮化物、酸、碱、盐类，这些物质会损伤 LED。

Avoid touching or contaminating the water, trichloroethylene, acetone, sulfide, nitride, acid, alkali, and salts that can damage leds.

8.3. 灌封/enbedment

- 8.3.1 挥发性物质会渗透到 LED 内部，在通电产生光子及热的条件下，会导致 LED 变色，进而造成严重光衰，严禁使用任何对 LED 器件的性能或者可靠性有害的物质或材料，针对特定的用途和使用环境，建议对所有的物质和材料进行相容性的测试。在贴装 LED 时候，不要使用能产生有机挥发性气体的粘结剂。

Volatile substances to leach into the LED inside, photons in electricity and heat conditions, will lead to the LED color, thus causing serious droop, it is forbidden to use any of the LED device performance or reliability of harmful substances or materials, for a specific purpose and use of the environment, advice on all the material and the material compatibility test. When attaching LED, do not use adhesive that can produce volatile organic gas.

- 8.3.2 使用正常灌密封胶时，建议先以少量试验，常温点亮 168 小时，确定没有问题再作业。

It is recommended to light up for 168 hours at room temperature for a small amount of test before using normal filling and sealing glue.

8.4. 保存/save

- 8.4.1 打开包装前，LED 应存储在温度 30℃或以下，相对湿度在 RH60%以下，一年内使用。

Before opening the package, LED should be stored in a temperature 30 °C or below, under RH60 % relative humidity, used in a year.

- 8.4.2 LED 是湿度敏感元件,为避免元件吸湿,打开包装后,LED 应在温度 30℃或以下,相对湿度在 60%以内,使用时间 7 天。LED 吸潮后,回流焊时可能裂胶,影响发光颜色. 对于未使用的散件, 请去潮处理 (卷装品: 烘烤 60℃±5℃/24H; 散装品: 烘烤 105℃±5℃/1H), 然后再用铝箔袋密封后保存或者储存在氮气防潮柜内。

LED is humidity sensitive element, element to avoid moisture absorption, after open the packing, the LED should be in temperature 30 °C or below, within 60% relative humidity, using time 7 days. After moisture absorption, LED may crack when reflow soldering, influence the luminous color. For bulk is not used, please deal with the tide (for package product: bake 60 °C + / - 5 °C / 24 h. For bulk goods: baking 105 °C + 5 °C, 1 hours), and then save after sealed with aluminum foil bag or stored in nitrogen moistureproof enclosure

- 8.4.3 保存环境中避免有酸、碱以及腐蚀气体存在，同时避免强烈震动及强磁场作用。

Avoid the presence of acid, alkali and corrosive gas in the preservation environment, and avoid strong vibration and strong magnetic field.

8.5. 静电/electrostatic

- 8.5.1 静电或峰值浪涌电压会损坏 LED,避免在开灯、关灯时产生瞬时电压。
 Static electricity or peak surge voltage will damage the LED, avoiding instantaneous voltage when the lamp is turned on or off.
- 8.5.2 建议使用 LED 时佩戴防静电手腕带,防静电手套,穿防静电鞋,使用的设备、仪器正确接地。LED 损坏后,表现出漏电流明显增加,低电流正向电压变低,低电流点不亮等现象。
 It is recommended to wear anti-static wrist bands, anti-static gloves and anti-static shoes when using LED. The equipment and instruments used are properly grounded. After the LED was damaged, the leakage current increased obviously, the forward voltage of low current became lower, and the low current point did not light, etc.

8.6 测试/test

- 8.6.1 LED 要在额定电流下驱动,同时电路中需要加限流电阻保护; 否则,轻微的电压变化就会引起较大的电流变化,从而破坏 LED。
 LED shall be driven at rated current, and shall be protected by current-limiting resistance in the circuit. Otherwise, slight voltage changes will cause large current changes, which will damage the LED.
- 8.6.2 在电路导通或关闭情况下,要避免瞬间浪涌电压的产生,否则 LED 将被烧坏。
 When the circuit is on or off, avoid sudden surge voltage. Otherwise, the LED will be burnt out
 请参照下图示检测 LED:/Please check the LED as shown

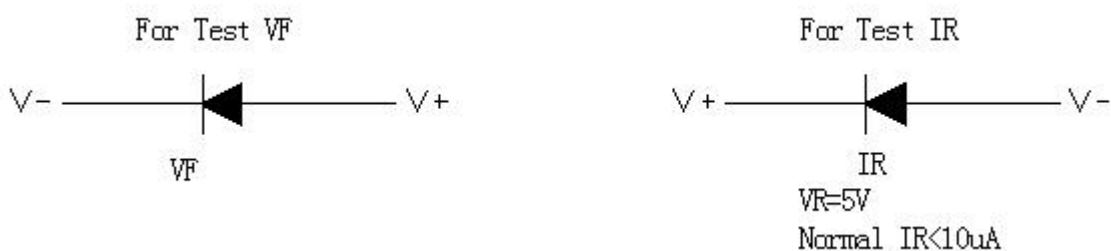

- 8.6.3 顺向电压 VF 过高或反向电压 VR 过高, 均会损坏 LED。
 If the forward voltage VF is too high or the reverse voltage VR is too high, the LED will be damaged.
- 8.6.4 点亮或测试 LED 时, 加在 LED 两端的反向电压不得高于 5V, 否则容易击伤 LED。
 When lighting or testing the LED, the reverse voltage added on both ends of the LED shall not be higher than 5V, otherwise it is easy to damage the LED.

8.6.5 LED 发光颜色会随着工作电流不同而有少许变化,建议设计时考虑电阻与 LED 串联使用。

LED luminous color will vary slightly with the working current. It is suggested that resistance and LED should be used in series in the design

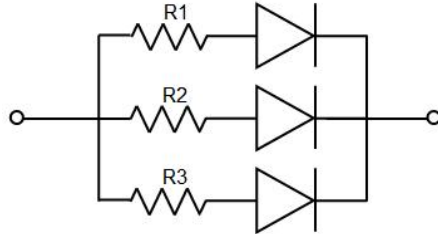

8.6.6 LED 容易因为自身的发热和环境的温度改变而改变, 温度升高会降低 LED 发光效率, 影响发光颜色在设计时应充分考虑散热问题。

LED is easy to change due to its own heat and changes in the temperature of the environment. The increase in temperature will reduce the luminous efficiency of LED, which will affect the luminous color. Heat dissipation should be fully considered in the design