



SPECIFICATION FOR APPROVAL

File No.: Q/FRK 0.GS.E.C32-C14

Product Name	Metallized polypropylene film capacitor (Box-type)
Product Type	MKP21
Product Code	C32
Customer	
Customer Code	
Issue Date	2023-05

Xiamen Faratronic Co. Ltd.			Approved by Customer
Drafted	Checked	Approved	



Xiamen Faratronic Co. Ltd.

Add: 99 Xinyuan Road, Haicang District, Xiamen, China

Marketing/Sales center

TEL: 0086-592-6208620/6208618/6208589/6208505

FAX: 0086-592-6208777

Mail: Vitawang@faratronic.com.cn

michael_lai@faratronic.com.cn

chris@faratronic.com.cn

donny@faratronic.com.cn

Http: www.faratronic.com.cn

*The specification are the property of Xiamen Faratronic Co.Ltd and shall not be copied or used as commercial purposes without permission.

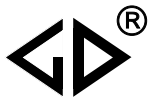

Version history

Current version	Date	Author	Change description

Metallized polypropylene film capacitor (Box-type)

■ Outline Drawing

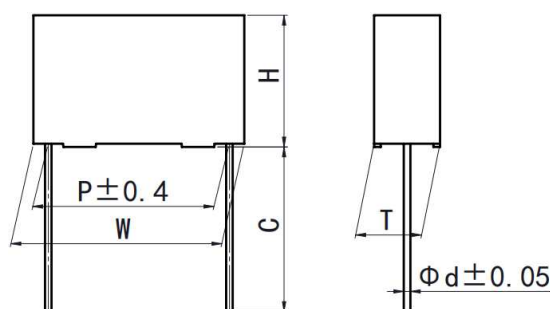

$W \pm 0.4, H \pm 0.4, T \pm 0.4$

■ Features

- Metallized polypropylene structure
- Low loss at high frequency
- Small inherent temperature rise
- Plastic case (UL94 V-0), Epoxy resin sealing

■ Typical application

- Widely used in high frequency, DC, AC and pulse circuits
- S-correction circuits for TV sets and monitors

■ Specifications

Reference Standard	GB/T 10190 (IEC 60384-16)						
Climatic Category	55/105/56						
Rated temperature	85°C						
Operating temperature	-55°C~105°C (+85°C to +105°C: decreasing factor 1.25% per °C for U_R)						
Rated Voltage	160Vdc(90Vac); 250Vdc(160Vac); 400Vdc(220Vac); 630Vdc(250Vac); 1 000Vdc(400Vac); 1 600Vdc(600Vac); 2 000Vdc(700Vac)						
Capacitance Range	0.00056~15.0μF						
Capacitance Tolerance	±2% (G), ±3% (H), ±5% (J), ±10% (K), ±20% (M)						
Voltage Proof	1.6 U_R (5s)						
Dissipation Factor	$\leq 10 \times 10^{-4}$ (20°C, 1kHz)						
Insulation Resistance	$R \geq 100\ 000\ \Omega$, $C_N \leq 0.33\ \mu\text{F}$ $RC_N \geq 30\ 000\ \text{s}$, $C_N > 0.33\ \mu\text{F}$ (20°C, 100V, 1min)						
Maximum Pulse Rise Time(dV/dt) If the working voltage(U) is lower than the rated voltage(U_R),the capacitor can be worked at a higher dV/dt. In this case, the maximum allowed dV/dt is obtain by multiplying the right value with U_R/U .	U_R (V)	dV/dt(V/us)					
		P=5.0	P=7.5	P=10.0	P=15.0	P=22.5	P=27.5
	160	110	310	190	110	65	55
	250	270	660	560	310	130	110
	400	440	900	780	600	300	130
	630	550	1500	1200	900	400	200
	1 000	--	--	2200	2 000	800	--
	1 600	--	--	--	4 500	1 800	--
2 000	--	--	--	9 500	4 500	--	

■ Part number system

The 15 digits part number is formed as follow:

1 2 3 4 5 6 7 8 9 10 11 12 13 14 15

C	3	2												
---	---	---	--	--	--	--	--	--	--	--	--	--	--	--

Digit 1 to 3 Series code

C32=MKP21

Digit 4 to 5 D.C. rated voltage

2C=160V 2E=250V 2G=400V

2J=630V 3A=1000V 3C=1600V

3D=2000V

Digit 6 to 8 Rated capacitance value

For example : 103=10×10³ pF= 0.01μF

Digit 9 Capacitance tolerance

G=±2%, H=±3%, J=±5%

K=±10%, M=±20%

Digit 10 Pitch

2=5.0mm 3=7.5mm 4=10mm

6=15mm 9=22.5mm B=27.5mm

Digit 11 Internal use

Digit 12 to 15 Lead form and packaging code

Table 1 Lead form and packaging code

Digit 12		Digit 13		Digit 14		Digit 15	
code	explanation	code	explanation	code	explanation	code	explanation
A	ammo-pack	2	F=5.0mm	0	straight	1	each cap. among two consecutive holes P3=12.7mm,H=18.5mm (For pitch=5.0/7.5mm)
		3	F=7.5mm				
		4	F=10.0mm				
		6	F=15.0mm				
C	straight lead “C” in the figure above	co	explanation	0		0	Length tolerance ±0.5mm Or standard length
		00	standard lead length (18mm~26mm)				
		45	lead length 4.5mm				

Note: Recommend short lead due to long lead could deform easily.

■ Dimensions (mm)

160V(90Vac)						
C _N (μF)	W	H	T	P	d	Part number
0.027	7.2	7.5	3.5	5.0	0.5	C322C273-20****
0.033	7.2	7.5	3.5	5.0	0.5	C322C333-20****
0.039	7.2	7.5	3.5	5.0	0.5	C322C393-20****
0.047	7.2	9.5	4.5	5.0	0.6	C322C473-20****
0.056	7.2	9.5	4.5	5.0	0.6	C322C563-20****
0.068	7.2	9.5	4.5	5.0	0.6	C322C683-20****
0.082	7.2	10.0	5.0	5.0	0.6	C322C823-20****
0.10	7.2	10.0	5.0	5.0	0.6	C322C104-20****
0.12	7.2	11.0	6.0	5.0	0.6	C322C124-20****
0.15	7.2	11.0	6.0	5.0	0.6	C322C154-20****
0.068	10.5	9.0	4.0	7.5	0.6	C322C683-30****
0.082	10.5	9.0	4.0	7.5	0.6	C322C823-30****
0.10	10.5	11.0	5.0	7.5	0.6	C322C104-30****
0.12	10.5	11.0	5.0	7.5	0.6	C322C124-30****
0.15	10.5	12.0	6.0	7.5	0.6	C322C154-30****
0.18	10.5	12.0	6.0	7.5	0.6	C322C184-30****
0.082	13.0	9.0	4.0	10.0	0.6	C322C823-40****
0.10	13.0	9.0	4.0	10.0	0.6	C322C104-40****
0.12	13.0	11.0	5.0	10.0	0.6	C322C124-40****
0.15	13.0	11.0	5.0	10.0	0.6	C322C154-40****
0.18	13.0	11.0	5.0	10.0	0.6	C322C184-40****
0.22	13.0	12.0	6.0	10.0	0.6	C322C224-40****
0.27	13.0	12.0	6.0	10.0	0.6	C322C274-40****
0.18	17.5	11.0	5.0	15.0	0.8	C322C184-60****
0.22	17.5	11.0	5.0	15.0	0.8	C322C224-60****
0.27	17.5	11.0	5.0	15.0	0.8	C322C274-60****
0.33	17.5	11.0	5.0	15.0	0.8	C322C334-60****
0.39	17.5	12.0	6.0	15.0	0.8	C322C394-60****
0.47	17.5	12.0	6.0	15.0	0.8	C322C474-60****
0.56	17.5	13.5	7.5	15.0	0.8	C322C564-60****
0.68	17.5	13.5	7.5	15.0	0.8	C322C684-60****

160V(90Vac)						
C _N (μF)	W	H	T	P	d	Part number
0.82	17.5	14.5	8.5	15.0	0.8	C322C824-60****
1.0	17.5	16.0	10.0	15.0	0.8	C322C105-60****
1.2	17.5	16.0	10.0	15.0	0.8	C322C125-60****
1.5	17.5	19.0	11.0	15.0	0.8	C322C155-60****
1.8	17.5	19.0	11.0	15.0	0.8	C322C185-60****
0.47	26.5	15.0	6.0	22.5	0.8	C322C474-90****
0.56	26.5	15.0	6.0	22.5	0.8	C322C564-90****
0.68	26.5	15.0	6.0	22.5	0.8	C322C684-90****
0.82	26.5	16.0	7.0	22.5	0.8	C322C824-90****
1.0	26.5	16.0	7.0	22.5	0.8	C322C105-90****
1.2	26.5	17.0	8.5	22.5	0.8	C322C125-90****
1.5	26.5	17.0	8.5	22.5	0.8	C322C155-90****
1.8	26.5	18.5	10.0	22.5	0.8	C322C185-90****
2.2	26.5	20.0	11.0	22.5	0.8	C322C225-90****
2.7	26.5	22.0	12.0	22.5	0.8	C322C275-90****
3.3	26.5	22.0	12.0	22.5	0.8	C322C335-90****
1.0	32.0	18.0	9.0	27.5	0.8	C322C105-B0****
1.2	32.0	18.0	9.0	27.5	0.8	C322C125-B0****
1.5	32.0	18.0	9.0	27.5	0.8	C322C155-B0****
1.8	32.0	18.0	9.0	27.5	0.8	C322C185-B0****
2.2	32.0	18.0	9.0	27.5	0.8	C322C225-B0****
2.7	32.0	20.0	11.0	27.5	0.8	C322C275-B0****
3.3	32.0	20.0	11.0	27.5	0.8	C322C335-B0****
3.9	32.0	22.0	13.0	27.5	0.8	C322C395-B0****
4.7	32.0	28.0	14.0	27.5	0.8	C322C475-B0****
5.6	32.0	24.5	15.0	27.5	0.8	C322C565-B0****
6.8	32.0	33.0	18.0	27.5	0.8	C322C685-B0****
8.2	32.0	33.0	18.0	27.5	0.8	C322C825-B0****
10.0	32.0	33.0	18.0	27.5	0.8	C322C106-B0****
12.0	32.0	37.0	22.0	27.5	0.8	C322C126-B0****
15.0	32.0	37.0	22.0	27.5	0.8	C322C156-B0****

- Note: 1. “-” =capacitance tolerance code, M=±20%,K=±10%,J=±5%,H=±3%,G=±2%
 2. “****” =lead form and packaging code (refer to table 1).

■ Dimensions (mm)

250V(160Vac)						
C _N (μF)	W	H	T	P	d	Part number
0.012	7.2	7.5	3.5	5.0	0.5	C322E123-20****
0.015	7.2	7.5	3.5	5.0	0.5	C322E153-20****
0.018	7.2	7.5	3.5	5.0	0.5	C322E183-20****
0.022	7.2	7.5	3.5	5.0	0.5	C322E223-20****
0.027	7.2	7.5	3.5	5.0	0.5	C322E273-20****
0.033	7.2	7.5	3.5	5.0	0.5	C322E333-20****
0.039	7.2	7.5	3.5	5.0	0.5	C322E393-20****
0.047	7.2	9.5	4.5	5.0	0.6	C322E473-20****
0.056	7.2	9.5	4.5	5.0	0.6	C322E563-20****
0.068	7.2	10.0	5.0	5.0	0.6	C322E683-20****
0.082	7.2	10.0	5.0	5.0	0.6	C322E823-20****
0.10	7.2	11.0	6.0	5.0	0.6	C322E104-20****
0.12	7.2	11.0	6.0	5.0	0.6	C322E124-20****
0.027	10.5	9.0	4.0	7.5	0.6	C322E273-30****
0.033	10.5	9.0	4.0	7.5	0.6	C322E333-30****
0.039	10.5	9.0	4.0	7.5	0.6	C322E393-30****
0.047	10.5	9.0	4.0	7.5	0.6	C322E473-30****
0.056	10.5	9.0	4.0	7.5	0.6	C322E563-30****
0.068	10.5	9.0	4.0	7.5	0.6	C322E683-30****
0.082	10.5	11.0	5.0	7.5	0.6	C322E823-30****
0.10	10.5	11.0	5.0	7.5	0.6	C322E104-30****
0.12	10.5	11.0	5.0	7.5	0.6	C322E124-30****
0.15	10.5	12.0	6.0	7.5	0.6	C322E154-30****
0.18	10.5	12.0	6.0	7.5	0.6	C322E184-30****
0.033	13.0	9.0	4.0	10.0	0.6	C322E333-40****
0.039	13.0	9.0	4.0	10.0	0.6	C322E393-40****
0.047	13.0	9.0	4.0	10.0	0.6	C322E473-40****
0.056	13.0	9.0	4.0	10.0	0.6	C322E563-40****
0.068	13.0	9.0	4.0	10.0	0.6	C322E683-40****
0.082	13.0	9.0	4.0	10.0	0.6	C322E823-40****
0.10	13.0	11.0	5.0	10.0	0.6	C322E104-40****
0.12	13.0	11.0	5.0	10.0	0.6	C322E124-40****
0.15	13.0	11.0	5.0	10.0	0.6	C322E154-40****
0.18	13.0	12.0	6.0	10.0	0.6	C322E184-40****
0.22	13.0	12.0	6.0	10.0	0.6	C322E224-40****
0.10	17.5	11.0	5.0	15.0	0.8	C322E104-60****
0.12	17.5	11.0	5.0	15.0	0.8	C322E124-60****
0.15	17.5	11.0	5.0	15.0	0.8	C322E154-60****

250V(160Vac)						
C _N (μF)	W	H	T	P	d	Part number
0.18	17.5	11.0	5.0	15.0	0.8	C322E184-60****
0.22	17.5	11.0	5.0	15.0	0.8	C322E224-60****
0.27	17.5	12.0	6.0	15.0	0.8	C322E274-60****
0.33	17.5	12.0	6.0	15.0	0.8	C322E334-60****
0.39	17.5	13.5	7.5	15.0	0.8	C322E394-60****
0.47	17.5	13.5	7.5	15.0	0.8	C322E474-60****
0.56	17.5	13.5	7.5	15.0	0.8	C322E564-60****
0.68	17.5	14.5	8.5	15.0	0.8	C322E684-60****
0.82	17.5	16.0	10.0	15.0	0.8	C322E824-60****
1.0	17.5	16.0	10.0	15.0	0.8	C322E105-60****
1.2	17.5	19.0	11.0	15.0	0.8	C322E125-60****
0.39	26.5	15.0	6.0	22.5	0.8	C322E394-90****
0.47	26.5	15.0	6.0	22.5	0.8	C322E474-90****
0.56	26.5	15.0	6.0	22.5	0.8	C322E564-90****
0.68	26.5	15.0	6.0	22.5	0.8	C322E684-90****
0.82	26.5	15.0	6.0	22.5	0.8	C322E824-90****
1.0	26.5	16.0	7.0	22.5	0.8	C322E105-90****
1.2	26.5	17.0	8.5	22.5	0.8	C322E125-90****
1.5	26.5	17.0	8.5	22.5	0.8	C322E155-90****
1.8	26.5	18.5	10.0	22.5	0.8	C322E185-90****
2.2	26.5	20.0	11.0	22.5	0.8	C322E225-90****
2.7	26.5	22.0	12.0	22.5	0.8	C322E275-90****
0.82	32.0	18.0	9.0	27.5	0.8	C322E824-B0****
1.0	32.0	18.0	9.0	27.5	0.8	C322E105-B0****
1.2	32.0	18.0	9.0	27.5	0.8	C322E125-B0****
1.5	32.0	18.0	9.0	27.5	0.8	C322E155-B0****
1.8	32.0	18.0	9.0	27.5	0.8	C322E185-B0****
2.2	32.0	18.0	9.0	27.5	0.8	C322E225-B0****
2.7	32.0	20.0	11.0	27.5	0.8	C322E275-B0****
3.3	32.0	20.0	11.0	27.5	0.8	C322E335-B0****
3.9	32.0	22.0	13.0	27.5	0.8	C322E395-B0****
4.7	32.0	28.0	14.0	27.5	0.8	C322E475-B0****
5.6	32.0	24.5	15.0	27.5	0.8	C322E565-B0****
6.8	32.0	33.0	18.0	27.5	0.8	C322E685-B0****
8.2	32.0	33.0	18.0	27.5	0.8	C322E825-B0****
10.0	32.0	33.0	18.0	27.5	0.8	C322E106-B0****
12.0	32.0	37.0	22.0	27.5	0.8	C322E126-B0****
15.0	32.0	37.0	22.0	27.5	0.8	C322E156-B0****

- Note: 1. “-” =capacitance tolerance code, M=±20%,K=±10%,J=±5%, H=±3%,G=±2%
 2. “****” =lead form and packaging code (refer to table 1).

■ Dimensions (mm)

400V(220Vac) [@]						
C _N (μF)	W	H	T	P	d	Part number
0.0039	7.2	7.5	3.5	5.0	0.5	C322G392-20****
0.0047	7.2	7.5	3.5	5.0	0.5	C322G472-20****
0.0056	7.2	7.5	3.5	5.0	0.5	C322G562-20****
0.0068	7.2	7.5	3.5	5.0	0.5	C322G682-20****
0.0082	7.2	7.5	3.5	5.0	0.5	C322G822-20****
0.010	7.2	7.5	3.5	5.0	0.5	C322G103-20****
0.012	7.2	7.5	3.5	5.0	0.5	C322G123-20****
0.015	7.2	9.5	4.5	5.0	0.6	C322G153-20****
0.018	7.2	9.5	4.5	5.0	0.6	C322G183-20****
0.022	7.2	9.5	4.5	5.0	0.6	C322G223-20****
0.027	7.2	10.0	5.0	5.0	0.6	C322G273-20****
0.033	7.2	11.0	6.0	5.0	0.6	C322G333-20****
0.039	7.2	11.0	6.0	5.0	0.6	C322G393-20****
0.047	7.2	11.0	6.0	5.0	0.6	C322G473-20****
0.010	10.5	9.0	4.0	7.5	0.6	C322G103-30****
0.012	10.5	9.0	4.0	7.5	0.6	C322G123-30****
0.015	10.5	9.0	4.0	7.5	0.6	C322G153-30****
0.018	10.5	9.0	4.0	7.5	0.6	C322G183-30****
0.022	10.5	9.0	4.0	7.5	0.6	C322G223-30****
0.027	10.5	9.0	4.0	7.5	0.6	C322G273-30****
0.033	10.5	11.0	5.0	7.5	0.6	C322G333-30****
0.039	10.5	11.0	5.0	7.5	0.6	C322G393-30****
0.047	10.5	11.0	5.0	7.5	0.6	C322G473-30****
0.056	10.5	12.0	6.0	7.5	0.6	C322G563-30****
0.068	10.5	12.0	6.0	7.5	0.6	C322G683-30****
0.015	13.0	9.0	4.0	10.0	0.6	C322G153-40****
0.018	13.0	9.0	4.0	10.0	0.6	C322G183-40****
0.022	13.0	9.0	4.0	10.0	0.6	C322G223-40****
0.027	13.0	9.0	4.0	10.0	0.6	C322G273-40****
0.033	13.0	9.0	4.0	10.0	0.6	C322G333-40****
0.039	13.0	9.0	4.0	10.0	0.6	C322G393-40****
0.047	13.0	11.0	5.0	10.0	0.6	C322G473-40****
0.056	13.0	11.0	5.0	10.0	0.6	C322G563-40****
0.068	13.0	11.0	5.0	10.0	0.6	C322G683-40****
0.082	13.0	12.0	6.0	10.0	0.6	C322G823-40****
0.10	13.0	12.0	6.0	10.0	0.6	C322G104-40****
0.068	17.5	11.0	5.0	15.0	0.8	C322G683-60****

400V(220Vac) [@]						
C _N (μF)	W	H	T	P	d	Part number
0.082	17.5	11.0	5.0	15.0	0.8	C322G823-60****
0.10	17.5	11.0	5.0	15.0	0.8	C322G104-60****
0.12	17.5	11.0	5.0	15.0	0.8	C322G124-60****
0.15	17.5	12.0	6.0	15.0	0.8	C322G154-60****
0.18	17.5	12.0	6.0	15.0	0.8	C322G184-60****
0.22	17.5	13.5	7.5	15.0	0.8	C322G224-60****
0.27	17.5	13.5	7.5	15.0	0.8	C322G274-60****
0.33	17.5	14.5	8.5	15.0	0.8	C322G334-60****
0.39	17.5	16.0	10.0	15.0	0.8	C322G394-60****
0.47	17.5	16.0	10.0	15.0	0.8	C322G474-60****
0.56	17.5	19.0	11.0	15.0	0.8	C322G564-60****
0.68	17.5	19.0	11.0	15.0	0.8	C322G684-60****
0.18	26.5	15.0	6.0	22.5	0.8	C322G184-90****
0.22	26.5	15.0	6.0	22.5	0.8	C322G224-90****
0.27	26.5	15.0	6.0	22.5	0.8	C322G274-90****
0.33	26.5	15.0	6.0	22.5	0.8	C322G334-90****
0.39	26.5	16.0	7.0	22.5	0.8	C322G394-90****
0.47	26.5	16.0	7.0	22.5	0.8	C322G474-90****
0.56	26.5	17.0	8.5	22.5	0.8	C322G564-90****
0.68	26.5	17.0	8.5	22.5	0.8	C322G684-90****
0.82	26.5	18.5	10.0	22.5	0.8	C322G824-90****
1.0	26.5	20.0	11.0	22.5	0.8	C322G105-90****
1.2	26.5	22.0	12.0	22.5	0.8	C322G125-90****
1.5	26.5	22.0	12.0	22.5	0.8	C322G155-90****
0.56	32.0	18.0	9.0	27.5	0.8	C322G564-B0****
0.68	32.0	18.0	9.0	27.5	0.8	C322G684-B0****
0.82	32.0	18.0	9.0	27.5	0.8	C322G824-B0****
1.0	32.0	18.0	9.0	27.5	0.8	C322G105-B0****
1.2	32.0	20.0	11.0	27.5	0.8	C322G125-B0****
1.5	32.0	20.0	11.0	27.5	0.8	C322G155-B0****
1.8	32.0	22.0	13.0	27.5	0.8	C322G185-B0****
2.2	32.0	24.5	15.0	27.5	0.8	C322G225-B0****
2.7	32.0	28.0	14.0	27.5	0.8	C322G275-B0****
3.3	32.0	33.0	18.0	27.5	0.8	C322G335-B0****
3.9	32.0	33.0	18.0	27.5	0.8	C322G395-B0****
4.7	32.0	37.0	22.0	27.5	0.8	C322G475-B0****
5.6	32.0	37.0	22.0	27.5	0.8	C322G565-B0****

Note: 1. "-" =capacitance tolerance code, M=±20%,K=±10%,J=±5%, H=±3%,G=±2%

2. "****" =lead form and packaging code (refer to table 1).

3. "@ " Not suitable for across-the-line application. Pls refer to Interference Suppression Capacitors.

■ Dimensions (mm)

630V(250Vac) [®]							630V(250Vac) [®]							630V(250Vac) [®]						
C _N (μF)	W	H	T	P	d	Part number	C _N (μF)	W	H	T	P	d	Part number	C _N (μF)	W	H	T	P	d	Part number
0.0010	7.2	7.5	3.5	5.0	0.5	C322J102-20****	0.027	10.5	12.0	6.0	7.5	0.6	C322J273-30****	0.12	17.5	13.5	7.5	15.0	0.8	C322J124-60****
0.0012	7.2	7.5	3.5	5.0	0.5	C322J122-20****	0.033	10.5	12.0	6.0	7.5	0.6	C322J333-30****	0.15	17.5	13.5	7.5	15.0	0.8	C322J154-60****
0.0015	7.2	7.5	3.5	5.0	0.5	C322J152-20****	0.0010	13.0	9.0	4.0	10.0	0.6	C322J102-40****	0.18	17.5	14.5	8.5	15.0	0.8	C322J184-60****
0.0018	7.2	7.5	3.5	5.0	0.5	C322J182-20****	0.0012	13.0	9.0	4.0	10.0	0.6	C322J122-40****	0.22	17.5	16.0	10.0	15.0	0.8	C322J224-60****
0.0022	7.2	7.5	3.5	5.0	0.5	C322J222-20****	0.0015	13.0	9.0	4.0	10.0	0.6	C322J152-40****	0.27	17.5	19.0	11.0	15.0	0.8	C322J274-60****
0.0027	7.2	7.5	3.5	5.0	0.5	C322J272-20****	0.0018	13.0	9.0	4.0	10.0	0.6	C322J182-40****	0.33	17.5	19.0	11.0	15.0	0.8	C322J334-60****
0.0033	7.2	7.5	3.5	5.0	0.5	C322J332-20****	0.0022	13.0	9.0	4.0	10.0	0.6	C322J222-40****	0.082	26.5	15.0	6.0	22.5	0.8	C322J823-90****
0.0039	7.2	9.5	4.5	5.0	0.6	C322J392-20****	0.0027	13.0	9.0	4.0	10.0	0.6	C322J272-40****	0.10	26.5	15.0	6.0	22.5	0.8	C322J104-90****
0.0047	7.2	9.5	4.5	5.0	0.6	C322J472-20****	0.0033	13.0	9.0	4.0	10.0	0.6	C322J332-40****	0.12	26.5	15.0	6.0	22.5	0.8	C322J124-90****
0.0056	7.2	10.0	5.0	5.0	0.6	C322J562-20****	0.0039	13.0	9.0	4.0	10.0	0.6	C322J392-40****	0.15	26.5	15.0	6.0	22.5	0.8	C322J154-90****
0.0068	7.2	10.0	5.0	5.0	0.6	C322J682-20****	0.0047	13.0	9.0	4.0	10.0	0.6	C322J472-40****	0.18	26.5	15.0	6.0	22.5	0.8	C322J184-90****
0.0082	7.2	11.0	6.0	5.0	0.6	C322J822-20****	0.0056	13.0	9.0	4.0	10.0	0.6	C322J562-40****	0.22	26.5	16.0	7.0	22.5	0.8	C322J224-90****
0.010	7.2	11.0	6.0	5.0	0.6	C322J103-20****	0.0068	13.0	9.0	4.0	10.0	0.6	C322J682-40****	0.27	26.5	17.0	8.5	22.5	0.8	C322J274-90****
0.012	7.2	11.0	6.0	5.0	0.6	C322J123-20****	0.0082	13.0	9.0	4.0	10.0	0.6	C322J822-40****	0.33	26.5	17.0	8.5	22.5	0.8	C322J334-90****
0.0010	10.5	9.0	4.0	7.5	0.6	C322J102-30****	0.010	13.0	9.0	4.0	10.0	0.6	C322J103-40****	0.39	26.5	18.5	10.0	22.5	0.8	C322J394-90****
0.0012	10.5	9.0	4.0	7.5	0.6	C322J122-30****	0.012	13.0	9.0	4.0	10.0	0.6	C322J123-40****	0.47	26.5	18.5	10.0	22.5	0.8	C322J474-90****
0.0015	10.5	9.0	4.0	7.5	0.6	C322J152-30****	0.015	13.0	9.0	4.0	10.0	0.6	C322J153-40****	0.56	26.5	20.0	11.0	22.5	0.8	C322J564-90****
0.0018	10.5	9.0	4.0	7.5	0.6	C322J182-30****	0.018	13.0	9.0	4.0	10.0	0.6	C322J183-40****	0.68	26.5	22.0	12.0	22.5	0.8	C322J684-90****
0.0022	10.5	9.0	4.0	7.5	0.6	C322J222-30****	0.022	13.0	11.0	5.0	10.0	0.6	C322J223-40****	0.33	32.0	18.0	9.0	27.5	0.8	C322J334-B0****
0.0027	10.5	9.0	4.0	7.5	0.6	C322J272-30****	0.027	13.0	11.0	5.0	10.0	0.6	C322J273-40****	0.39	32.0	18.0	9.0	27.5	0.8	C322J394-B0****
0.0033	10.5	9.0	4.0	7.5	0.6	C322J332-30****	0.033	13.0	11.0	5.0	10.0	0.6	C322J333-40****	0.47	32.0	18.0	9.0	27.5	0.8	C322J474-B0****
0.0039	10.5	9.0	4.0	7.5	0.6	C322J392-30****	0.039	13.0	12.0	6.0	10.0	0.6	C322J393-40****	0.56	32.0	20.0	11.0	27.5	0.8	C322J564-B0****
0.0047	10.5	9.0	4.0	7.5	0.6	C322J472-30****	0.047	13.0	12.0	6.0	10.0	0.6	C322J473-40****	0.68	32.0	20.0	11.0	27.5	0.8	C322J684-B0****
0.0056	10.5	9.0	4.0	7.5	0.6	C322J562-30****	0.027	17.5	11.0	5.0	15.0	0.8	C322J273-60****	0.82	32.0	20.0	11.0	27.5	0.8	C322J824-B0****
0.0068	10.5	9.0	4.0	7.5	0.6	C322J682-30****	0.033	17.5	11.0	5.0	15.0	0.8	C322J333-60****	1.0	32.0	22.0	13.0	27.5	0.8	C322J105-B0****
0.0082	10.5	9.0	4.0	7.5	0.6	C322J822-30****	0.039	17.5	11.0	5.0	15.0	0.8	C322J393-60****	1.2	32.0	24.5	15.0	27.5	0.8	C322J125-B0****
0.010	10.5	9.0	4.0	7.5	0.6	C322J103-30****	0.047	17.5	11.0	5.0	15.0	0.8	C322J473-60****	1.5	32.0	28.0	14.0	27.5	0.8	C322J155-B0****
0.012	10.5	9.0	4.0	7.5	0.6	C322J123-30****	0.056	17.5	11.0	5.0	15.0	0.8	C322J563-60****	1.8	32.0	33.0	18.0	27.5	0.8	C322J185-B0****
0.015	10.5	11.0	5.0	7.5	0.6	C322J153-30****	0.068	17.5	12.0	6.0	15.0	0.8	C322J683-60****	2.2	32.0	33.0	18.0	27.5	0.8	C322J225-B0****
0.018	10.5	11.0	5.0	7.5	0.6	C322J183-30****	0.082	17.5	12.0	6.0	15.0	0.8	C322J823-60****	2.7	32.0	37.0	22.0	27.5	0.8	C322J275-B0****
0.022	10.5	11.0	5.0	7.5	0.6	C322J223-30****	0.10	17.5	13.5	7.5	15.0	0.8	C322J104-60****	3.3	32.0	37.0	22.0	27.5	0.8	C322J335-B0****

Note: 1. “-” =capacitance tolerance code, M=±20%,K=±10%,J=±5%, H=±3%,G=±2%

2. “****” =lead form and packaging code (refer to table 1).

3. “@” Not suitable for across-the-line application. Pls refer to Interference Suppression Capacitors.

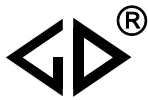

■ Dimensions (mm)

1 000Vdc(400Vac)							1 000Vdc(400Vac)							1 000Vdc(400Vac)						
C _N (μF)	W	H	T	P	d	Part number	C _N (μF)	W	H	T	P	d	Part number	C _N (μF)	W	H	T	P	d	Part number
0.0010	13.0	9.0	4.0	10.0	0.6	C323A102-40****	0.012	17.5	11.0	5.0	15.0	0.8	C323A123-60****	0.22	26.5	22.0	12.0	22.5	0.8	C323A224-91****
0.0012	13.0	9.0	4.0	10.0	0.6	C323A122-40****	0.015	17.5	12.0	6.0	15.0	0.8	C323A153-60****	0.27	26.5	22.0	12.0	22.5	0.8	C323A274-9S****
0.0015	13.0	9.0	4.0	10.0	0.6	C323A152-40****	0.018	17.5	12.0	6.0	15.0	0.8	C323A183-60****	0.33	26.5	22.0	12.0	22.5	0.8	C323A334-91****
0.0018	13.0	9.0	4.0	10.0	0.6	C323A182-40****	0.022	17.5	13.5	7.5	15.0	0.8	C323A223-60****	0.39	26.5	24.5	15.5	22.5	0.8	C323A394-9S****
0.0022	13.0	9.0	4.0	10.0	0.6	C323A222-40****	0.027	17.5	13.5	7.5	15.0	0.8	C323A273-60****	0.47	26.5	29.5	14.5	22.5	0.8	C323A474-91****
0.0027	13.0	9.0	4.0	10.0	0.6	C323A272-40****	0.033	17.5	14.5	8.5	15.0	0.8	C323A333-60****	0.18	32.0	18.0	9.0	27.5	0.8	C323A184-BS****
0.0033	13.0	9.0	4.0	10.0	0.6	C323A332-40****	0.039	17.5	16.0	10.0	15.0	0.8	C323A393-60****	0.22	32.0	20.0	11.0	27.5	0.8	C323A224-BS****
0.0039	13.0	9.0	4.0	10.0	0.6	C323A392-40****	0.047	17.5	16.0	10.0	15.0	0.8	C323A473-60****	0.27	32.0	20.0	11.0	27.5	0.8	C323A274-BS****
0.0047	13.0	11.0	5.0	10.0	0.6	C323A472-40****	0.056	17.5	19.0	11.0	15.0	0.8	C323A563-60****	0.33	32.0	20.0	11.0	27.5	0.8	C323A334-B2****
0.0056	13.0	11.0	5.0	10.0	0.6	C323A562-40****	0.068	17.5	19.0	11.0	15.0	0.8	C323A683-60****	0.39	32.0	22.0	13.0	27.5	0.8	C323A394-BS****
0.0068	13.0	11.0	5.0	10.0	0.6	C323A682-40****	0.018	26.5	15.0	6.0	22.5	0.8	C323A183-90****	0.47	32.0	24.5	15.0	27.5	0.8	C323A474-BS****
0.0082	13.0	12.0	6.0	10.0	0.6	C323A822-40****	0.022	26.5	15.0	6.0	22.5	0.8	C323A223-90****	0.56	32.0	28.0	14.0	27.5	0.8	C323A564-BS****
0.010	13.0	12.0	6.0	10.0	0.6	C323A103-40****	0.027	26.5	15.0	6.0	22.5	0.8	C323A273-90****	0.68	32.0	28.0	17.0	27.5	0.8	C323A684-BS****
0.0022	17.5	11.0	5.0	15.0	0.8	C323A222-60****	0.033	26.5	15.0	6.0	22.5	0.8	C323A333-90****	0.82	32.0	29.0	19.0	27.5	0.8	C323A824-BS****
0.0027	17.5	11.0	5.0	15.0	0.8	C323A272-60****	0.039	26.5	15.0	6.0	22.5	0.8	C323A393-90****	1.00	32.0	33.0	18.0	27.5	0.8	C323A105-B1****
0.0033	17.5	11.0	5.0	15.0	0.8	C323A332-60****	0.047	26.5	16.0	7.0	22.5	0.8	C323A473-90****	1.20	32.0	37.0	22.0	27.5	0.8	C323A125-BS****
0.0039	17.5	11.0	5.0	15.0	0.8	C323A392-60****	0.056	26.5	16.0	7.0	22.5	0.8	C323A563-90****							
0.0047	17.5	11.0	5.0	15.0	0.8	C323A472-60****	0.068	26.5	17.0	8.5	22.5	0.8	C323A683-90****							
0.0056	17.5	11.0	5.0	15.0	0.8	C323A562-60****	0.082	26.5	17.0	8.5	22.5	0.8	C323A823-90****							
0.0068	17.5	11.0	5.0	15.0	0.8	C323A682-60****	0.10	26.5	18.5	10.0	22.5	0.8	C323A104-90****							
0.0082	17.5	11.0	5.0	15.0	0.8	C323A822-60****	0.12	26.5	22.0	12.0	22.5	0.8	C323A124-90****							
0.010	17.5	11.0	5.0	15.0	0.8	C323A103-60****	0.15	26.5	22.0	12.0	22.5	0.8	C323A154-90****							

1 600Vdc(600Vac)							1 600Vdc(600Vac)							1 600Vdc(600Vac)						
C _N (μF)	W	H	T	P	d	Part number	C _N (μF)	W	H	T	P	d	Part number	C _N (μF)	W	H	T	P	d	Part number
0.00056	17.5	11.0	5.0	15.0	0.8	C323C561-60****	0.012	17.5	12.0	6.0	15.0	0.8	C323C123-60****	0.082	26.5	22.0	12.0	22.5	0.8	C323C823-90****
0.00062	17.5	11.0	5.0	15.0	0.8	C323C621-60****	0.015	17.5	13.5	7.5	15.0	0.8	C323C153-60****	0.10	26.5	22.0	12.0	22.5	0.8	C323C104-90****
0.00068	17.5	11.0	5.0	15.0	0.8	C323C681-60****	0.018	17.5	13.5	7.5	15.0	0.8	C323C183-60****	0.12	26.5	24.5	15.5	22.5	0.8	C323C124-90****
0.00082	17.5	11.0	5.0	15.0	0.8	C323C821-60****	0.022	17.5	14.5	8.5	15.0	0.8	C323C223-60****	0.15	26.5	29.5	14.5	22.5	0.8	C323C154-9A****
0.0010	17.5	11.0	5.0	15.0	0.8	C323C102-60****	0.027	17.5	16.0	10.0	15.0	0.8	C323C273-60****	0.047	32.0	18.0	9.0	27.5	0.8	C323C473-BA****
0.0012	17.5	11.0	5.0	15.0	0.8	C323C122-60****	0.033	17.5	16.0	10.0	15.0	0.8	C323C333-60****	0.056	32.0	18.0	9.0	27.5	0.8	C323C563-BA****
0.0015	17.5	11.0	5.0	15.0	0.8	C323C152-60****	0.039	17.5	19.0	11.0	15.0	0.8	C323C393-60****	0.068	32.0	20.0	11.0	27.5	0.8	C323C683-BA****
0.0018	17.5	11.0	5.0	15.0	0.8	C323C182-60****	0.047	17.5	19.0	11.0	15.0	0.8	C323C473-60****	0.082	32.0	20.0	11.0	27.5	0.8	C323C823-BA****
0.0022	17.5	11.0	5.0	15.0	0.8	C323C222-60****	0.015	26.5	15.0	6.0	22.5	0.8	C323C153-90****	0.10	32.0	22.0	13.0	27.5	0.8	C323C104-BA****
0.0027	17.5	11.0	5.0	15.0	0.8	C323C272-60****	0.018	26.5	15.0	6.0	22.5	0.8	C323C183-90****	0.12	32.0	24.5	15.5	27.5	0.8	C323C124-BA****
0.0033	17.5	11.0	5.0	15.0	0.8	C323C332-60****	0.022	26.5	15.0	6.0	22.5	0.8	C323C223-90****	0.15	32.0	24.5	15.5	27.5	0.8	C323C154-B0****
0.0039	17.5	11.0	5.0	15.0	0.8	C323C392-60****	0.027	26.5	16.0	7.0	22.5	0.8	C323C273-90****	0.18	32.0	28.0	17.0	27.5	0.8	C323C184-BA****
0.0047	17.5	11.0	5.0	15.0	0.8	C323C472-60****	0.033	26.5	16.0	7.0	22.5	0.8	C323C333-90****	0.22	32.0	29.0	19.0	27.5	0.8	C323C224-BA****
0.0056	17.5	11.0	5.0	15.0	0.8	C323C562-60****	0.039	26.5	17.0	8.5	22.5	0.8	C323C393-90****	★0.27	32.0	30.0	21.0	27.5	0.8	C323C274-BA****
0.0068	17.5	11.0	5.0	15.0	0.8	C323C682-60****	0.047	26.5	18.5	10.0	22.5	0.8	C323C473-90****	0.33	32.0	37.0	22.0	27.5	0.8	C323C334-BA****
0.0082	17.5	12.0	6.0	15.0	0.8	C323C822-60****	0.056	26.5	18.5	10.0	22.5	0.8	C323C563-90****	0.39	32.0	37.0	22.0	27.5	0.8	C323C394-BA****
0.010	17.5	12.0	6.0	15.0	0.8	C323C103-60****	0.068	26.5	22.0	12.0	22.5	0.8	C323C683-90****							

- Note: 1. “-” =capacitance tolerance code, M=±20%,K=±10%,J=±5%, H=±3%,G=±2%
 2. “****” =lead form and packaging code (refer to table 1).
 3. “★” = Arc bottom of the outer shell



■ Dimensions (mm)

2 000Vdc(700Vac)							2 000Vdc(700Vac)							2 000Vdc(700Vac)						
C _N (μF)	W	H	T	P	d	Part number	C _N (μF)	W	H	T	P	d	Part number	C _N (μF)	W	H	T	P	d	Part number
0.00056	17.5	11.0	5.0	15.0	0.8	C323D561-60****	0.012	17.5	14.5	8.5	15.0	0.8	C323D123-60****	0.082	26.5	29.5	14.5	22.5	0.8	C323D823-9A****
0.00062	17.5	11.0	5.0	15.0	0.8	C323D621-60****	0.015	17.5	14.5	8.5	15.0	0.8	C323D153-60****	0.033	32.0	18.0	9.0	27.5	0.8	C323D333-BA****
0.00068	17.5	11.0	5.0	15.0	0.8	C323D681-60****	0.018	17.5	16.0	10.0	15.0	0.8	C323D183-60****	0.039	32.0	20.0	11.0	27.5	0.8	C323D393-BA****
0.00082	17.5	11.0	5.0	15.0	0.8	C323D821-60****	0.022	17.5	19.0	11.0	15.0	0.8	C323D223-60****	0.047	32.0	20.0	11.0	27.5	0.8	C323D473-BA****
0.0010	17.5	11.0	5.0	15.0	0.8	C323D102-60****	0.0068	26.5	15.0	6.0	22.5	0.8	C323D682-90****	0.056	32.0	22.0	13.0	27.5	0.8	C323D563-BA****
0.0012	17.5	11.0	5.0	15.0	0.8	C323D122-60****	0.0082	26.5	15.0	6.0	22.5	0.8	C323D822-90****	0.068	32.0	24.5	15.0	27.5	0.8	C323D683-BA****
0.0015	17.5	11.0	5.0	15.0	0.8	C323D152-60****	0.010	26.5	15.0	6.0	22.5	0.8	C323D103-90****	0.082	32.0	24.5	15.0	27.5	0.8	C323D823-BA****
0.0018	17.5	11.0	5.0	15.0	0.8	C323D182-60****	0.012	26.5	15.0	6.0	22.5	0.8	C323D123-90****	0.10	32.0	28.0	14.0	27.5	0.8	C323D104-BA****
0.0022	17.5	11.0	5.0	15.0	0.8	C323D222-60****	0.015	26.5	15.0	6.0	22.5	0.8	C323D153-90****	0.12	32.0	29.0	19.0	27.5	0.8	C323D124-BA****
0.0027	17.5	11.0	5.0	15.0	0.8	C323D272-60****	0.018	26.5	16.0	7.0	22.5	0.8	C323D183-90****	0.15	32.0	33.0	18.0	27.5	0.8	C323D154-BA****
0.0033	17.5	11.0	5.0	15.0	0.8	C323D332-60****	0.022	26.5	17.0	8.5	22.5	0.8	C323D223-90****	0.18	32.0	37.0	22.0	27.5	0.8	C323D184-BA****
0.0039	17.5	11.0	5.0	15.0	0.8	C323D392-60****	0.027	26.5	17.0	8.5	22.5	0.8	C323D273-90****	0.22	32.0	37.0	22.0	27.5	0.8	C323D224-BA****
0.0047	17.5	11.0	5.0	15.0	0.8	C323D472-60****	0.033	26.5	18.5	10.0	22.5	0.8	C323D333-90****							
0.0056	17.5	12.0	6.0	15.0	0.8	C323D562-60****	0.039	26.5	18.5	10.0	22.5	0.8	C323D393-90****							
0.0068	17.5	12.0	6.0	15.0	0.8	C323D682-60****	0.047	26.5	22.0	12.0	22.5	0.8	C323D473-90****							
0.0082	17.5	13.5	7.5	15.0	0.8	C323D822-60****	0.056	26.5	22.0	12.0	22.5	0.8	C323D563-90****							
0.010	17.5	13.5	7.5	15.0	0.8	C323D103-60****	0.068	26.5	24.5	15.5	22.5	0.8	C323D683-9A****							

- Note: 1. “-” =capacitance tolerance code, M=±20%,K=±10%,J=±5%,H=±3%,G=±2%
 2. “****” =lead form and packaging code (refer to table 1).

■ MAX. VOLTAGE(Vr.m.s) VERSUS FREQUENCY

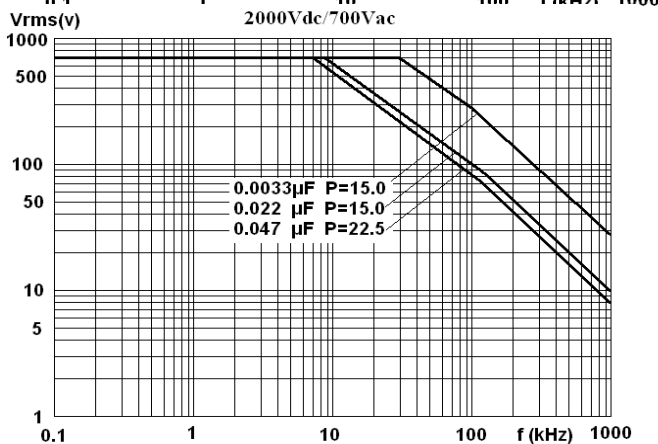
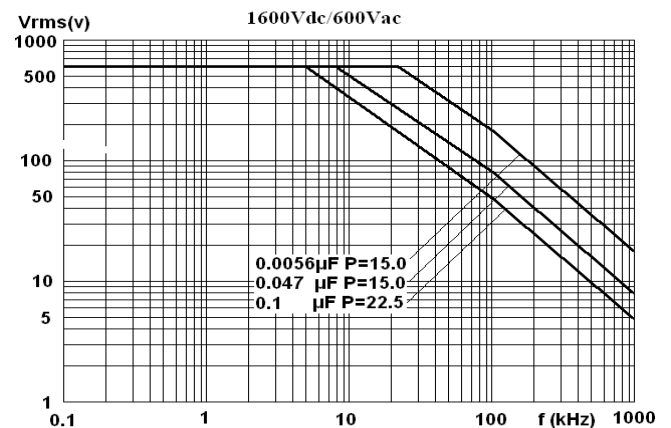
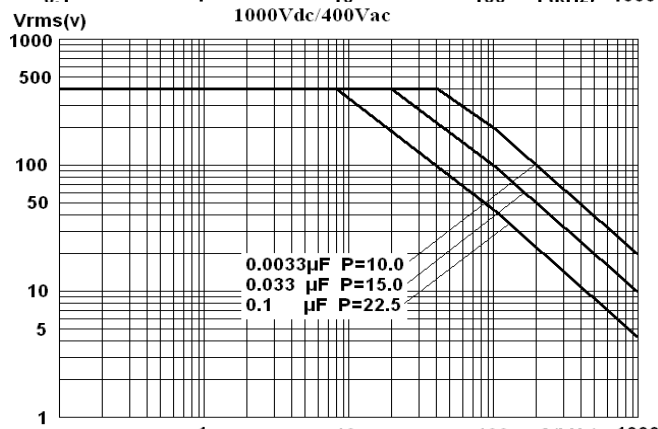
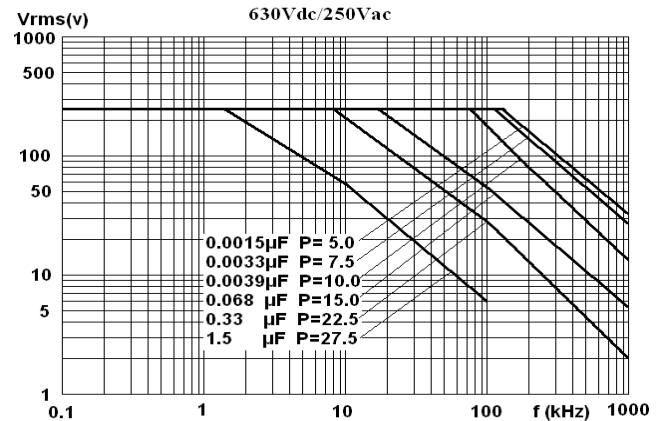
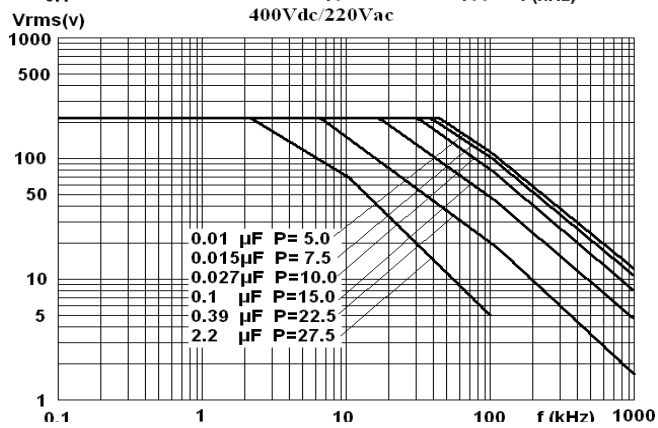
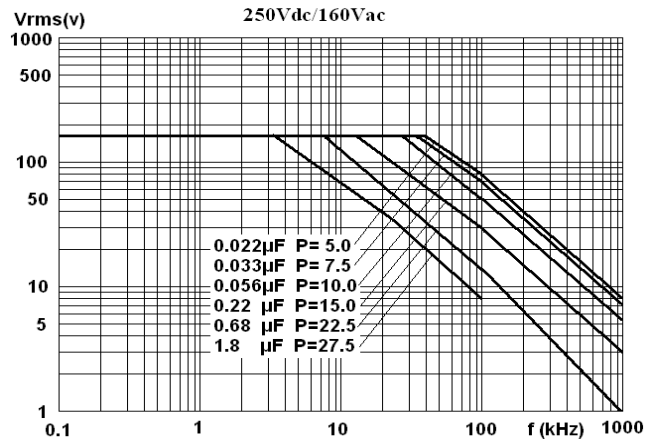
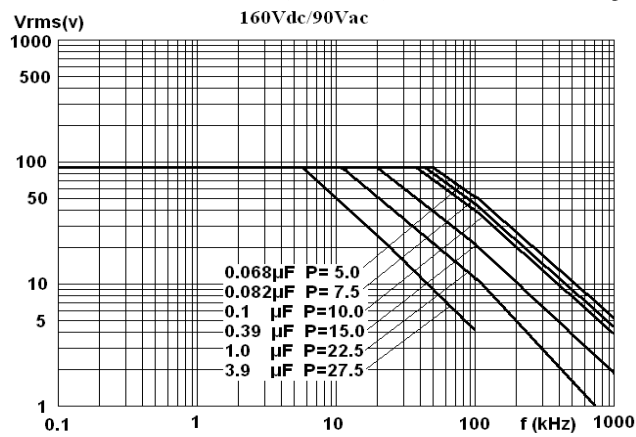

Note: sinusoidal wave-form, environment temperature $\leq 85^{\circ}\text{C}$, internal temperature rise $\Delta T=10^{\circ}\text{C}$, p (pitch) in mm..

MAX. CURRENT(Ir.m.s) VERSUS FREQUENCY

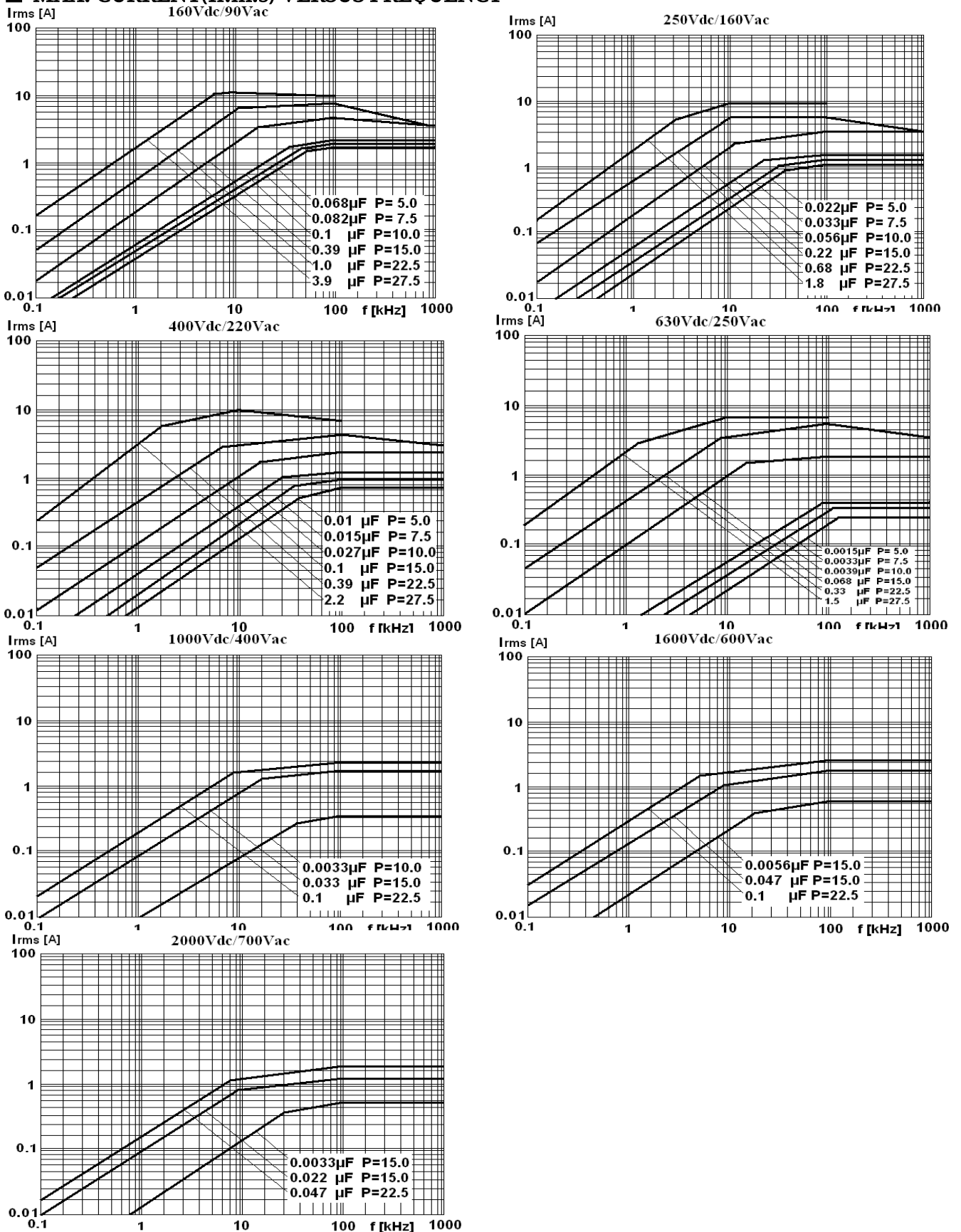

Note: sinusoidal wave-form, environment temperature $\leq 85^{\circ}\text{C}$, internal temperature rise $\Delta T=10^{\circ}\text{C}$, p (pitch) in mm.

■ Test Method And Performance

No.	Item	Performance	Test method(IEC 60384-16)
1	Solderability	Good quality of tinning	Solder temperature:245°C±5°C Immersion time: 2.0s±0.5s
2	Initial measurement	Capacitance Tgδ:1kHz, C>1.0μF 10kHz, C≤1.0μF	
	Terminal Strength (straight lead)	There shall be no visible damage	Tension: 0.6≤φd≤0.8mm, 10N φd=1.0mm, 20N Bend: 0.6≤φd≤0.8mm, 5N φd=1.0mm, 10N The terminals shall be bent 2 times in each direction.
	Resistance to solder heat	There shall be no visible damage	Solder temperature:260°C±5°C Immersion time: 10s±1s
	Final measurement	Δ C/C ≤ ± 3 % (relative to the initial value) Increase of tgδ: ≤0.004 (10kHz,C≤1.0μF) ≤0.004 (1kHz,C>1.0μF)	
3	Initial measurement	Capacitance Tgδ:1kHz, C>1.0μF 10kHz, C≤1.0μF	
	Rapid change of temperature	There shall be no evidence of deterioration.	θ _A =-55°C, θ _B =+105°C 5 cycles, Duration: t=30min
3	Vibration(straight lead)	There shall be no evidence of deterioration.	Amplitude 0.75mm or acceleration 98m/s ² (whichever is the smaller severity), f: 10Hz to 500Hz.Three directions, 2h for each direction, total 6h.
	Bump(straight lead)	There shall be no evidence of deterioration.	4 000 times, Acceleration: 390m/s ² ,Pulse duration, 6ms
	Final measurement	Δ C/C ≤ ± 3 % (relative to the initial value) Increase of tgδ: ≤0.004 (10kHz, C≤1.0μF) ≤0.004 (1kHz, C>1.0μF) IR: ≥ 50% of the rated value	
4	climate sequence	Initial measurement	Capacitance Tgδ:1kHz, C>1.0μF 10kHz, C≤1.0μF
		Dry heat	+105°C, 16h
		Damp heat, Cyclic	Test Db, Severity: b, the first cycle
		Cold	-55°C, 2h

		Low air pressure	There shall be no permanent breakdown, flashover or other harmful deformation when applying U_R at the last 1 minute.	15°C~35°C, 8.5kPa, 1h,
--	--	------------------	---	------------------------

No.	Item		Performance	Test method(IEC 60384-16)
4	climate sequence (continue)	Damp heat, cyclic other		Test Db, Severity b, the other cycles, Applying U_R for 1 minute after the test finished.
		Final measurement	There shall be no evidence of deterioration and the marking shall be legible. $\Delta C/C \leq \pm 5\%$ (relative to the initial value) Increase of $\text{tg}\delta$: ≤ 0.005 (10kHz, $C \leq 1.0\mu\text{F}$) ≤ 0.005 (1kHz, $C > 1.0\mu\text{F}$) IR: $\geq 50\%$ of the rated value	
5	Damp heat steady state		There shall be no evidence of deterioration and the marking shall be legible. $\Delta C/C \leq \pm 5\%$ (relative to the initial value) Increase of $\text{tg}\delta \leq 0.002$ (1kHz) IR: $\geq 50\%$ of the rated value	Temperature: 40°C $\pm 2^\circ\text{C}$ Humidity: $93 \pm 2\%$ RH Duration: 56 days
6	Endurance		$\Delta C/C \leq \pm 5\%$ (relative to the initial value) Increase of $\text{tg}\delta$: ≤ 0.004 (10kHz, $C \leq 1.0\mu\text{F}$) ≤ 0.004 (1kHz, $C > 1.0\mu\text{F}$) IR: $\geq 50\%$ of the rated value	Temperature: +85°C Voltage: $1.25 \times U_R$ Duration: 1 000h
7	Temperature characteristic		Measuring capacitance at test point b, d, f: Characteristic at lower category temperature -40°C: $0 \leq (C_b - C_d)/C_d \leq +3\%$ Characteristic at upper category temperature +85°C: $-3.25\% \leq (C_f - C_d)/C_d \leq 0$	Static method: The capacitors should be kept at the following temperature in turn: a. (+20 ± 2) °C, b. (-40 ± 2) °C, d. (20 ± 2) °C, f. (+85 ± 2) °C, g. (+20 ± 2) °C
8	Charging and discharging		$\Delta C/C \leq \pm 5\%$ (relative to the initial value) Increase of $\text{tg}\delta$: ≤ 0.005 (10kHz, $C \leq 1.0\mu\text{F}$) ≤ 0.005 (1kHz, $C > 1.0\mu\text{F}$) IR: $\geq 50\%$ of the rated value	Times: 10 000 Duration of charging: 0.5s Duration of discharging: 0.5s Charging voltage: rated voltage U_R Charging resistance: $220/C_N(\Omega)$ Discharging resistance: $U_R \div C_N \div \text{dv/dt}(\Omega)$ C_N : rated capacitance (μF) dv/dt value: see P2

■ Marking (For example)

103J 630
P=5mm

 103J 630
P=7.5mm&P=10mm

 MKP21
104J 630
P ≥ 15 mm

Marking Introduction:

	Brand	MKP21	Type
630	Rated voltage	103/104	Rated capacitance
J	Tolerance	-	-

■ Taping specification for box-type capacitors

▲ Outline Drawing

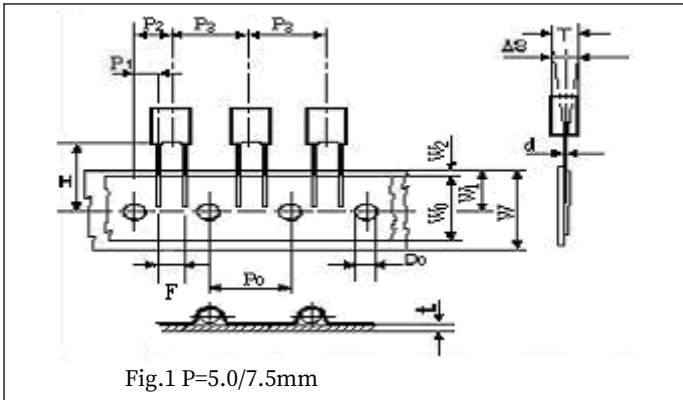

Fig.1 P=5.0/7.5mm

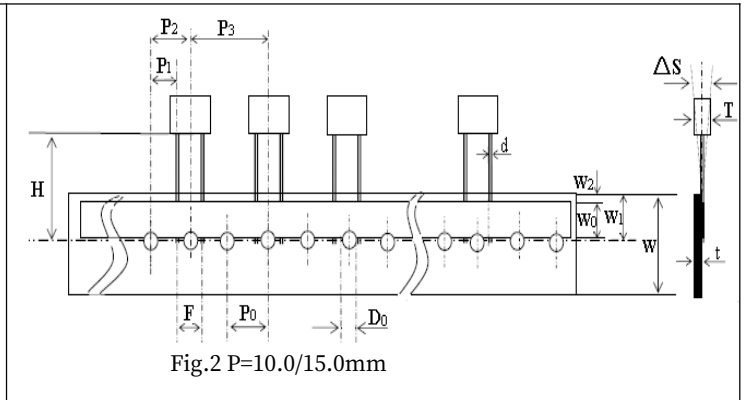

Fig.2 P=10.0/15.0mm

▲ Taping Dimensions(mm)

Technology index title	Code	Dimensions				Tolerance
		P=5.0	P=7.5	P=10.0	P=15.0	
Taping type	—	Fig 1	Fig 1	Fig2	Fig 2	—
Part number Digit12-15	Ammo-pack	A201	A301	A405	A605	
Taping pitch	P_3	12.7	12.7	25.4	25.4	± 1.0
Feed hole pitch	P_0	12.7	12.7	12.7	12.7	± 0.3
Center of wire	P_1	3.85	2.6	7.7	5.2	± 0.7
Center of body	P_2	6.35	6.35	12.7	12.7	± 1.3
Pitch of taping wire	F^{**}	5.0	7.5	10.0	15.0	+0.6 -0.1
Component alignment	ΔS	0	0	0	0	± 2.0
Height of component from tape center	H^{***}	18.5	18.5	18.5	18.5	± 0.5
Carrier tape width	W	18.0	18.0	18.0	18.0	+1.0 -0.5
Hold down tape width	W_0	6min	10min	10min	10min	—
Hole position	W_1	9.0	9.0	9.0	9.0	± 0.5
Hold down tape position	W_2	3max	3max	3max	3max	—
Feed hole dia.	D_0	4.0	4.0	4.0	4.0	± 0.2
Tape thickness	t	0.7	0.7	0.7	0.7	± 0.2

Note: * $P_0=15\text{mm}$ is also available;
 **F can be other lead spacing;
 ***H=16.5mm is available;

■ Soldering suggestions

▲ Manual soldering

Max. temperature: 350°C, time: 3s

▲ Wave soldering

There are many factors affecting the heating of film capacitor during the wave soldering process, such as: preheating temperature, preheating time, soldering temperature, soldering time, other heat sources influence and so on.

The typical soldering profile is as below:

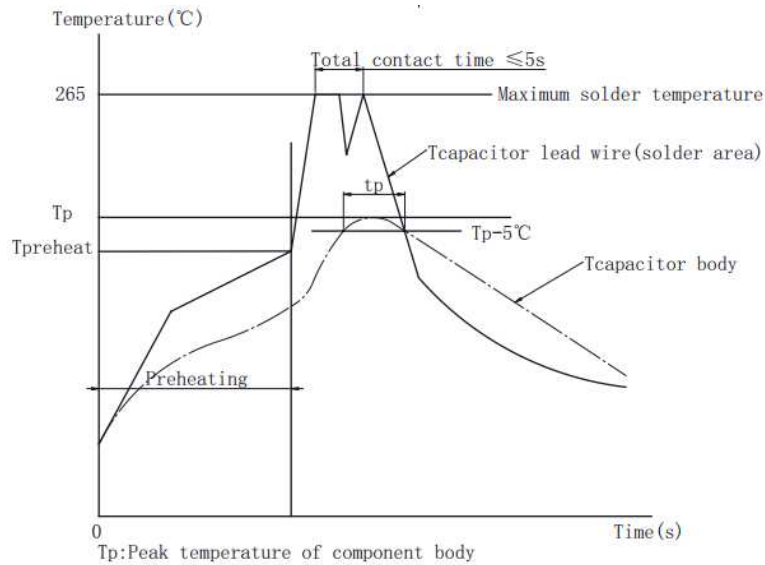

▲ Because overheating could damage the capacitor, we recommend paying attention to the maximum capacitor temperature and heating time, use temperature sensor to detect the maximum capacitor body temperature.

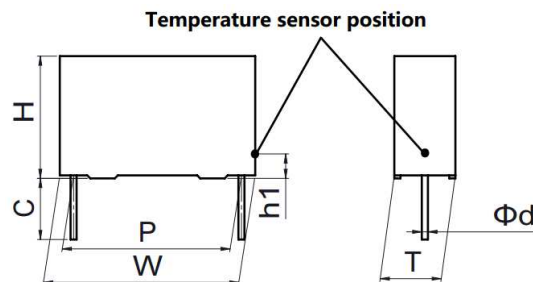

Note: If re-working or dipping twice is necessary, it should be done after the capacitor returns to the normal temperature.

Temperature sensor position (Tcapacitor body)	The capacitor body surface of lead side, capacitor height position from PCB: h1=2~3mm		
Maximum capacitor body temperature Tp(°C)	OPP film P≤15mm	OPP film P>15mm	PET film
	115	120	125
Maximum capacitor lead wire temperature (°C)	265	265	265
Maximum capacitor body heating time tp=Tp-5°C	30s		

■ Packing box sizes(mm)(example)

1. Out packing box for bulk

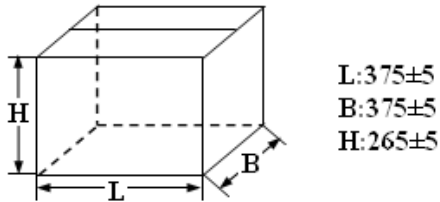

2. Inner packing box for bulk

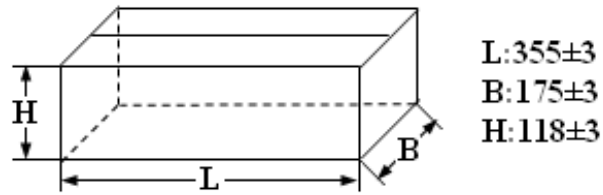

3. Box sizes for Ammo-pack

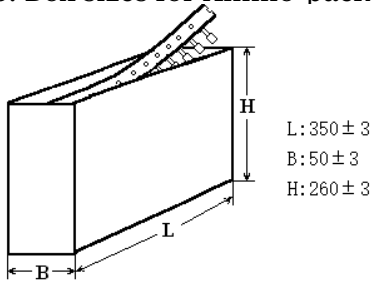

■ Storage conditions

▲ It must be noted that the solderability of the terminals may be deteriorated when stored in an atmosphere filled with moisture, dust, or a reactive oxidizing gas.(hydrogen chloride, hydrogen sulfide, sulfuric acid,etc.)

▲ It shouldn't be located in particularly high temperature and high humidity, it must submit to the following conditions(unchanging primal package):

Temperature: -40 °C to 35 °C

Humidity: Average per year ≤ 70%RH;

For 30 full days randomly distributed throughout the year ≤ 80%RH

Storage time for tinned lead wire: (from the date marked on the capacitor's body or the label glued to the package) :

Bulk(packed with plastic bag): ≤ 24 months ;

Taping and line up: ≤ 12 months