

RoHS
Compliant



SPECIFICATION FOR APPROVAL

File No.: Q/FRK 0.GS.E.C23-C13

Product Name Box-type metallized polyester film capacitor
Product Type: C23(CL23 Series)
Product Code
Customer
Customer Code
Issue Date 2023-05

Xiamen Faratronic Co. Ltd.			Approved by Customer
Drafted	Checked	Approved	



Xiamen Faratronic Co. Ltd.

Add: 99 Xinyuan Road, Haicang District, Xiamen, China

Marketing/Sales center

TEL: 0086-592-6208620/6208618/6208589/6208505

FAX: 0086-592-6208777

Mail: Vitawang@faratronic.com.cn

michael_lai@faratronic.com.cn

chris@faratronic.com.cn

donny@faratronic.com.cn

Http: www.faratronic.com.cn

*The specification are the property of Xiamen Faratronic Co.Ltd and shall not be copied or used as commercial purposes without permission.



Version history

Current version	Date	Author	Change description

Metallized polyester film capacitor (Box-type)

■ Outline Drawing

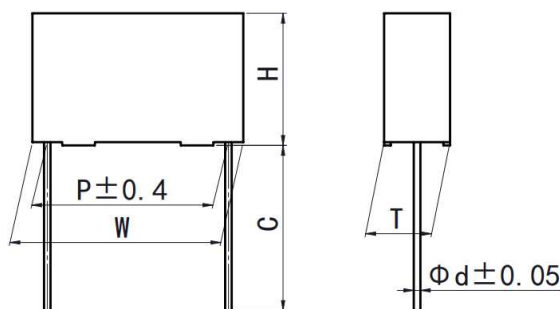

$W \pm 0.4, H \pm 0.4, T \pm 0.4$

■ Features

- High reliability
- Metallized polyester film, non-inductive wound construction
- Plastic case(UL94 V-0), epoxy resin sealing

■ Typical application

- by-passing, blocking, coupling, decoupling,
- pulse, logic, timing, oscillator circuits.

■ Specifications

Reference Standard	IEC 60384-2					
Climatic Category	55/105/56					
Rated temperature	85°C					
Operating temperature	-55°C~105°C (+85°C to +105°C: decreasing factor 1.25% per °C for U_R)					
Rated Voltage	63V, 100V, 250V, 400V, 630V, 1 000V					
Capacitance Range	0.0010μF~47.0μF					
Capacitance Tolerance	±5%(J), ±10%(K), ±20%(M)					
Voltage Proof	1.6 U_R (5s)					
Dissipation Factor	≤1.0% (20°C,1kHz)					
Insulation Resistance	$U_R > 100V$	$R \geq 15\,000M\Omega, C_N \leq 0.33\mu F$ $RC_N \geq 5\,000s, C_N > 0.33\mu F$ (20°C,100V,1min)				
	$U_R \leq 100V$	$R \geq 3\,750M\Omega, C_N \leq 0.33\mu F$ $RC_N \geq 1\,250s, C_N > 0.33\mu F$ (20°C,10V,1min)				
Maximum Pulse Rise Time(dV/dt) If the working voltage(U) is lower than the rated voltage(U_R),the capacitor can be worked at a higher dV/dt. In this case, the maximum allowed dV/dt is obtain by multiplying the right value with U_R/U .	$U_R(V)$	dV/dt (V/μs)				
		P=7.5	P=10.0	P=15.0	P=22.5	P=27.5
	63	7.5	6	3	2	1
	100	15	9	5	3	2
	250	30	20	12	8	5
	400	40	30	20	10	7
630	50	40	25	12	10	
1 000	70	60	30	15	12	

■ Part number system

The 15 digits part number is formed as follow:

1	2	3	4	5	6	7	8	9	10	11	12	13	14	15
C	2	3												

Digit 1 to 3 Series code

C23=CL23

Digit 4 to 5 DC rated voltage

1J=63V 2A=100V 2E=250V 2G=400V 2J=630V 3A=1 000V

Digit 6 to 8 Rated capacitance value

For example: 103=10×10³ pF= 0.01μF

Digit 9 Capacitance tolerance

J=±5%,K=±10%, M=±20%

Digit 10 Lead pitch

3=7.5mm 4=10.0mm 6=15.0mm 9=22.5mm B=27.5mm

Digit 11 Internal use

Digit 12 to 15 Lead form and packaging code

■ Table 1 Lead form and packaging code

Digit 12		Digit 13		Digit 14		Digit 15	
code	explanation	code	explanation	code	explanation	code	explanation
A	ammo-pack	3	F=7.5mm	0	straight	1	each cap. among two consecutive holes P3=12.7mm,H=18.5mm (For pitch=7.5mm)
		4	F=10.0mm				
		6	F=15.0mm				
C	straight lead “C” in the figure above	code	explanation	0		0	Length tolerance ±0.5mm Or standard length
		00	standard lead length (18mm~26mm)				
		45	lead length 4.5mm				

Note: Recommend short lead due to long lead could deform easily.

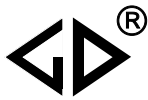

■ Dimensions (mm)

Pattern II (Reduced sizes)

63Vdc (40Vac)							100Vdc (63Vac)							250Vdc (160Vac)						
C _N (μF)	W	H	T	P	d	Part number	C _N (μF)	W	H	T	P	d	Part number	C _N (μF)	W	H	T	P	d	Part number
0.47	10.5	8.5	3.5	7.5	0.5	C231J474-3S****	0.22	10.5	8.5	3.5	7.5	0.5	C232A224-3S****	0.068	10.5	8.5	3.5	7.5	0.5	C232E683-3S****
0.68	10.5	9.0	4.0	7.5	0.6	C231J684-3S****	0.33	10.5	9.0	4.0	7.5	0.6	C232A334-3S****	0.10	10.5	8.5	3.5	7.5	0.5	C232E104-3S****
1.0	10.5	11.0	5.0	7.5	0.6	C231J105-3S****	0.39	10.5	9.0	4.0	7.5	0.6	C232A394-3S****	0.15	10.5	9.0	4.0	7.5	0.6	C232E154-3S****
1.5	10.5	12.0	6.0	7.5	0.6	C231J155-3S****	0.47	10.5	9.0	4.0	7.5	0.6	C232A474-3S****	0.18	10.5	11.0	5.0	7.5	0.6	C232E184-3S****
1.8	10.5	12.0	6.0	7.5	0.6	C231J185-3S****	0.68	10.5	11.0	5.0	7.5	0.6	C232A684-3S****	0.22	10.5	11.0	5.0	7.5	0.6	C232E224-3S****
0.10	13.0	9.0	4.0	10.0	0.6	C231J104-4S****	1.0	10.5	12.0	6.0	7.5	0.6	C232A105-3S****	0.27	10.5	12.0	6.0	7.5	0.6	C232E274-3S****
0.15	13.0	9.0	4.0	10.0	0.6	C231J154-4S****	0.10	13.0	9.0	4.0	10.0	0.6	C232A104-4S****	0.33	10.5	12.0	6.0	7.5	0.6	C232E334-3S****
0.22	13.0	9.0	4.0	10.0	0.6	C231J224-4S****	0.15	13.0	9.0	4.0	10.0	0.6	C232A154-4S****	0.033	13.0	9.0	4.0	10.0	0.6	C232E333-4S****
0.33	13.0	9.0	4.0	10.0	0.6	C231J334-4S****	0.22	13.0	9.0	4.0	10.0	0.6	C232A224-4S****	0.047	13.0	9.0	4.0	10.0	0.6	C232E473-4S****
0.47	13.0	9.0	4.0	10.0	0.6	C231J474-4S****	0.33	13.0	9.0	4.0	10.0	0.6	C232A334-4S****	0.068	13.0	9.0	4.0	10.0	0.6	C232E683-4S****
0.68	13.0	9.0	4.0	10.0	0.6	C231J684-4S****	0.47	13.0	9.0	4.0	10.0	0.6	C232A474-4S****	0.10	13.0	9.0	4.0	10.0	0.6	C232E104-4S****
1.0	13.0	9.0	4.0	10.0	0.6	C231J105-4S****	0.68	13.0	9.0	4.0	10.0	0.6	C232A684-4S****	0.15	13.0	9.0	4.0	10.0	0.6	C232E154-4S****
1.5	13.0	11.0	5.0	10.0	0.6	C231J155-4S****	1.0	13.0	11.0	5.0	10.0	0.6	C232A105-4S****	0.22	13.0	11.0	5.0	10.0	0.6	C232E224-4S****
1.8	13.0	12.0	6.0	10.0	0.6	C231J185-4S****	1.5	13.0	12.0	6.0	10.0	0.6	C232A155-4S****	0.33	13.0	11.0	5.0	10.0	0.6	C232E334-4S****
2.2	13.0	12.0	6.0	10.0	0.6	C231J225-4S****	0.33	17.5	11.0	5.0	15.0	0.8	C232A334-6S****	0.39	13.0	12.0	6.0	10.0	0.6	C232E394-4S****
0.68	17.5	11.0	5.0	15.0	0.8	C231J684-6S****	0.47	17.5	11.0	5.0	15.0	0.8	C232A474-6S****	0.47	13.0	12.0	6.0	10.0	0.6	C232E474-4S****
1.0	17.5	11.0	5.0	15.0	0.8	C231J105-6S****	0.68	17.5	11.0	5.0	15.0	0.8	C232A684-6S****	0.10	17.5	11.0	5.0	15.0	0.8	C232E104-6S****
1.5	17.5	11.0	5.0	15.0	0.8	C231J155-6S****	1.0	17.5	11.0	5.0	15.0	0.8	C232A105-6S****	0.15	17.5	11.0	5.0	15.0	0.8	C232E154-6S****
1.8	17.5	11.0	5.0	15.0	0.8	C231J185-6S****	1.5	17.5	12.0	6.0	15.0	0.8	C232A155-6S****	0.22	17.5	11.0	5.0	15.0	0.8	C232E224-6S****
2.2	17.5	11.0	5.0	15.0	0.8	C231J225-6S****	1.8	17.5	12.0	6.0	15.0	0.8	C232A185-6S****	0.33	17.5	11.0	5.0	15.0	0.8	C232E334-6S****
3.3	17.5	12.0	6.0	15.0	0.8	C231J335-6S****	2.2	17.5	12.0	6.0	15.0	0.8	C232A225-6S****	0.47	17.5	11.0	5.0	15.0	0.8	C232E474-6S****
4.7	17.5	13.5	7.5	15.0	0.8	C231J475-6S****	3.3	17.5	13.5	7.5	15.0	0.8	C232A335-6S****	0.68	17.5	12.0	6.0	15.0	0.8	C232E684-6S****
6.8	17.5	14.5	8.5	15.0	0.8	C231J685-6S****	4.7	17.5	14.5	8.5	15.0	0.8	C232A475-6S****	1.0	17.5	13.5	7.5	15.0	0.8	C232E105-6S****
10.0	17.5	19.0	11.0	15.0	0.8	C231J106-6S****	1.5	26.5	15.0	6.0	22.5	0.8	C232A155-9S****	1.5	17.5	14.5	8.5	15.0	0.8	C232E155-6S****
3.3	26.5	16.0	7.0	22.5	0.8	C231J335-9S****	1.8	26.5	15.0	6.0	22.5	0.8	C232A185-9S****	0.22	26.5	15.0	6.0	22.5	0.8	C232E224-9S****
4.7	26.5	16.0	7.0	22.5	0.8	C231J475-9S****	2.2	26.5	15.0	6.0	22.5	0.8	C232A225-9S****	0.47	26.5	15.0	6.0	22.5	0.8	C232E474-9S****
6.8	26.5	16.0	7.0	22.5	0.8	C231J685-9S****	3.3	26.5	15.0	6.0	22.5	0.8	C232A335-9S****	0.68	26.5	15.0	6.0	22.5	0.8	C232E684-9S****
10.0	26.5	17.0	8.5	22.5	0.8	C231J106-9S****	4.7	26.5	16.0	7.0	22.5	0.8	C232A475-9S****	1.0	26.5	15.0	6.0	22.5	0.8	C232E105-9S****
15.0	26.5	20.0	11.0	22.5	0.8	C231J156-9S****	6.8	26.5	18.5	10.0	22.5	0.8	C232A685-9S****	1.5	26.5	16.0	7.0	22.5	0.8	C232E155-9S****
4.7	32.0	18.0	9.0	27.5	0.8	C231J475-BS****	10.0	26.5	22.0	12.0	22.5	0.8	C232A106-9S****	1.8	26.5	16.0	7.0	22.5	0.8	C232E185-9S****
6.8	32.0	18.0	9.0	27.5	0.8	C231J685-BS****	4.7	32.0	18.0	9.0	27.5	0.8	C232A475-BS****	2.2	26.5	17.0	8.5	22.5	0.8	C232E225-9S****
10.0	32.0	18.0	9.0	27.5	0.8	C231J106-BS****	6.8	32.0	18.0	9.0	27.5	0.8	C232A685-BS****	3.3	26.5	20.0	11.0	22.5	0.8	C232E335-9S****
15.0	32.0	18.0	9.0	27.5	0.8	C231J156-BS****	10.0	32.0	20.0	11.0	27.5	0.8	C232A106-BS****	1.5	32.0	18.0	9.0	27.5	0.8	C232E155-BS****
22.0	32.0	22.0	13.0	27.5	0.8	C231J226-BS****	15.0	32.0	20.0	11.0	27.5	0.8	C232A156-BS****	1.8	32.0	18.0	9.0	27.5	0.8	C232E185-BS****
33.0	32.0	24.5	15.0	27.5	0.8	C231J336-BS****	22.0M	32.0	25.0	13.0	27.5	0.8	C232A226MBS****	2.2	32.0	18.0	9.0	27.5	0.8	C232E225-BS****
47.0	32.0	30.0	16.0	27.5	0.8	C231J476-BS****	33.0	32.0	30.0	16.0	27.5	0.8	C232A336-BS****	3.3	32.0	18.0	9.0	27.5	0.8	C232E335-BS****
														4.7	32.0	20.0	11.0	27.5	0.8	C232E475-BS****
														6.8	32.0	22.0	13.0	27.5	0.8	C232E685-BS****
														10.0	32.0	24.5	15.0	27.5	0.8	C232E106-BS****

Note: 1. "-" =capacitance tolerance code, M=±20%,K=±10%,J=±5%
 2. "****" =lead form and packing code (refer to table 1).

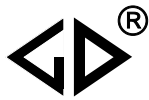

■ Dimensions (mm)

Pattern II (Reduced sizes)

400Vdc (200Vac)							630Vdc (220Vac)							1 000Vdc (300Vac)						
C _N (μF)	W	H	T	P	d	Part number	C _N (μF)	W	H	T	P	d	Part number	C _N (μF)	W	H	T	P	d	Part number
0.022	10.5	8.5	3.5	7.5	0.5	C232G223-3S****	0.0022	10.5	8.5	3.5	7.5	0.5	C232J222-3S****	0.0010	10.5	8.5	3.5	7.5	0.5	C233A102-3S****
0.033	10.5	8.5	3.5	7.5	0.5	C232G333-3S****	0.0047	10.5	8.5	3.5	7.5	0.5	C232J472-3S****	0.0015	10.5	8.5	3.5	7.5	0.5	C233A152-3S****
0.047	10.5	9.0	4.0	7.5	0.6	C232G473-3S****	0.0068	10.5	8.5	3.5	7.5	0.5	C232J682-3S****	0.0022	10.5	8.5	3.5	7.5	0.5	C233A222-3S****
0.068	10.5	11.0	5.0	7.5	0.6	C232G683-3S****	0.010	10.5	8.5	3.5	7.5	0.5	C232J103-3S****	0.0033	10.5	8.5	3.5	7.5	0.5	C233A332-3S****
0.082	10.5	12.0	6.0	7.5	0.6	C232G823-3S****	0.015	10.5	9.0	4.0	7.5	0.6	C232J153-3S****	0.0047	10.5	8.5	3.5	7.5	0.5	C233A472-3S****
0.10	10.5	12.0	6.0	7.5	0.6	C232G104-3S****	0.022	10.5	11.0	5.0	7.5	0.6	C232J223-3S****	0.0068	10.5	9.0	4.0	7.5	0.6	C233A682-3S****
0.010	13.0	9.0	4.0	10.0	0.6	C232G103-4S****	0.033	10.5	12.0	6.0	7.5	0.6	C232J333-3S****	0.010	10.5	11.0	5.0	7.5	0.6	C233A103-3S****
0.015	13.0	9.0	4.0	10.0	0.6	C232G153-4S****	0.047	10.5	12.0	6.0	7.5	0.6	C232J473-3S****	0.015	10.5	12.0	6.0	7.5	0.6	C233A153-3S****
0.022	13.0	9.0	4.0	10.0	0.6	C232G223-4S****	0.0047	13.0	9.0	4.0	10.0	0.6	C232J472-4S****	0.0010	13.0	9.0	4.0	10.0	0.6	C233A102-4S****
0.033	13.0	9.0	4.0	10.0	0.6	C232G333-4S****	0.0068	13.0	9.0	4.0	10.0	0.6	C232J682-4S****	0.0015	13.0	9.0	4.0	10.0	0.6	C233A152-4S****
0.047	13.0	9.0	4.0	10.0	0.6	C232G473-4S****	0.010	13.0	9.0	4.0	10.0	0.6	C232J103-4S****	0.0022	13.0	9.0	4.0	10.0	0.6	C233A222-4S****
0.056	13.0	9.0	4.0	10.0	0.6	C232G563-4S****	0.015	13.0	9.0	4.0	10.0	0.6	C232J153-4S****	0.0033	13.0	9.0	4.0	10.0	0.6	C233A332-4S****
0.068	13.0	11.0	5.0	10.0	0.6	C232G683-4S****	0.022	13.0	9.0	4.0	10.0	0.6	C232J223-4S****	0.0047	13.0	9.0	4.0	10.0	0.6	C233A472-4S****
0.10	13.0	11.0	5.0	10.0	0.6	C232G104-4S****	0.033	13.0	11.0	5.0	10.0	0.6	C232J333-4S****	0.0056	13.0	9.0	4.0	10.0	0.6	C233A562-4S****
0.15	13.0	12.0	6.0	10.0	0.6	C232G154-4S****	0.047	13.0	11.0	5.0	10.0	0.6	C232J473-4S****	0.0068	13.0	9.0	4.0	10.0	0.6	C233A682-4S****
0.047	17.5	11.0	5.0	15.0	0.8	C232G473-6S****	0.068	13.0	12.0	6.0	10.0	0.6	C232J683-4S****	0.010	13.0	9.0	4.0	10.0	0.6	C233A103-4S****
0.068	17.5	11.0	5.0	15.0	0.8	C232G683-6S****	0.033	17.5	11.0	5.0	15.0	0.8	C232J333-6S****	0.015	13.0	11.0	5.0	10.0	0.6	C233A153-4S****
0.10	17.5	11.0	5.0	15.0	0.8	C232G104-6S****	0.047	17.5	11.0	5.0	15.0	0.8	C232J473-6S****	0.022	13.0	11.0	5.0	10.0	0.6	C233A223-4S****
0.15	17.5	11.0	5.0	15.0	0.8	C232G154-6S****	0.068	17.5	11.0	5.0	15.0	0.8	C232J683-6S****	0.010	17.5	11.0	5.0	15.0	0.8	C233A103-6S****
0.22	17.5	12.0	6.0	15.0	0.8	C232G224-6S****	0.10	17.5	12.0	6.0	15.0	0.8	C232J104-6S****	0.015	17.5	11.0	5.0	15.0	0.8	C233A153-6S****
0.33	17.5	13.5	7.5	15.0	0.8	C232G334-6S****	0.15	17.5	13.5	7.5	15.0	0.8	C232J154-6S****	0.022	17.5	11.0	5.0	15.0	0.8	C233A223-6S****
0.47	17.5	14.5	8.5	15.0	0.8	C232G474-6S****	0.22	17.5	16.0	10.0	15.0	0.8	C232J224-6S****	0.033	17.5	12.0	6.0	15.0	0.8	C233A333-6S****
0.56	17.5	16.0	10.0	15.0	0.8	C232G564-6S****	0.33	17.5	19.0	11.0	15.0	0.8	C232J334-6S****	0.047	17.5	12.0	6.0	15.0	0.8	C233A473-6S****
0.68	17.5	16.0	10.0	15.0	0.8	C232G684-6S****	0.10	26.5	15.0	6.0	22.5	0.8	C232J104-9S****	0.068	17.5	13.5	7.5	15.0	0.8	C233A683-6S****
0.22	26.5	15.0	6.0	22.5	0.8	C232G224-9S****	0.15	26.5	15.0	6.0	22.5	0.8	C232J154-9S****	0.10	17.5	14.5	8.5	15.0	0.8	C233A104-6S****
0.33	26.5	15.0	6.0	22.5	0.8	C232G334-9S****	0.22	26.5	16.0	7.0	22.5	0.8	C232J224-9S****	0.033	26.5	15.0	6.0	22.5	0.8	C233A333-9S****
0.47	26.5	15.0	6.0	22.5	0.8	C232G474-9S****	0.33	26.5	16.0	7.0	22.5	0.8	C232J334-9S****	0.047	26.5	15.0	6.0	22.5	0.8	C233A473-9S****
0.68	26.5	16.0	7.0	22.5	0.8	C232G684-9S****	0.47	26.5	17.0	8.5	22.5	0.8	C232J474-9S****	0.068	26.5	15.0	6.0	22.5	0.8	C233A683-9S****
1.0	26.5	18.50	10.0	22.5	0.8	C232G105-9S****	0.68	26.5	22.0	12.0	22.5	0.8	C232J684-9S****	0.10	26.5	15.0	6.0	22.5	0.8	C233A104-9S****
1.5	26.5	22.0	12.0	22.5	0.8	C232G155-9S****	0.33	32.0	18.0	9.0	27.5	0.8	C232J334-BS****	0.15	26.5	16.0	7.0	22.5	0.8	C233A154-9S****
0.68	32.0	18.0	9.0	27.5	0.8	C232G684-BS****	0.47	32.0	18.0	9.0	27.5	0.8	C232J474-BS****	0.22	26.5	17.0	8.5	22.5	0.8	C233A224-9S****
1.0	32.0	18.0	9.0	27.5	0.8	C232G105-BS****	0.68	32.0	20.0	11.0	27.5	0.8	C232J684-BS****	0.33	26.5	20.0	11.0	22.5	0.8	C233A334-9S****
1.5	32.0	20.0	11.0	27.5	0.8	C232G155-BS****	1.0K	32.0	20.0	11.0	27.5	0.8	C232J105KBS****	0.15	32.0	18.0	9.0	27.5	0.8	C233A154-BS****
1.8	32.0	20.0	11.0	27.5	0.8	C232G185-BS****								0.22	32.0	18.0	9.0	27.5	0.8	C233A224-BS****
2.2	32.0	22.0	13.0	27.5	0.8	C232G225-BS****								0.33	32.0	20.0	11.0	27.5	0.8	C233A334-BS****
3.3	32.0	24.5	15.0	27.5	0.8	C232G335-BS****								0.47	32.0	20.0	11.0	27.5	0.8	C233A474-BS****
4.7	32.0	30.0	16.0	27.5	0.8	C232G475-BS****								0.68	32.0	28.0	14.0	27.5	0.8	C233A684-BS****
6.8	32.0	33.0	18.0	27.5	0.8	C232G685-BS****								1.0	32.0	30.0	16.0	27.5	0.8	C233A105-BS****
														1.5	32.0	37.0	22.0	27.5	0.8	C233A155-BS****

- Note: 1. “-” =capacitance tolerance code, M=±20%,K=±10%,J=±5%
 2. “****” =lead form and packing code (refer to table 1).
 3. “@” Not suitable for across-the-line applications. Pls refer to the Interference Suppression Capacitors.

■ MAX. VOLTAGE(Vr.m.s) VERSUS FREQUENCY

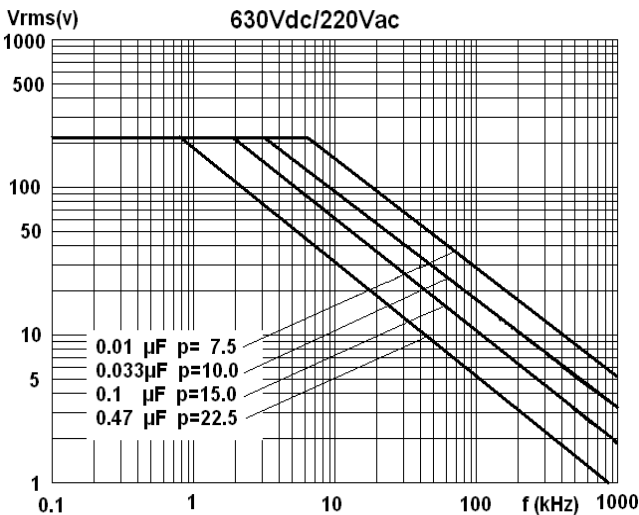
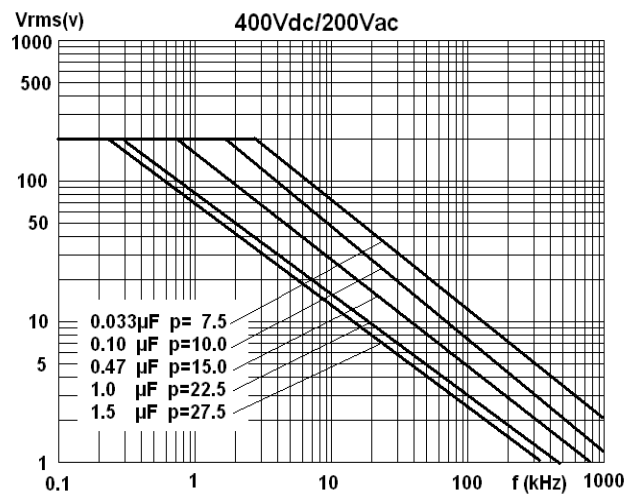
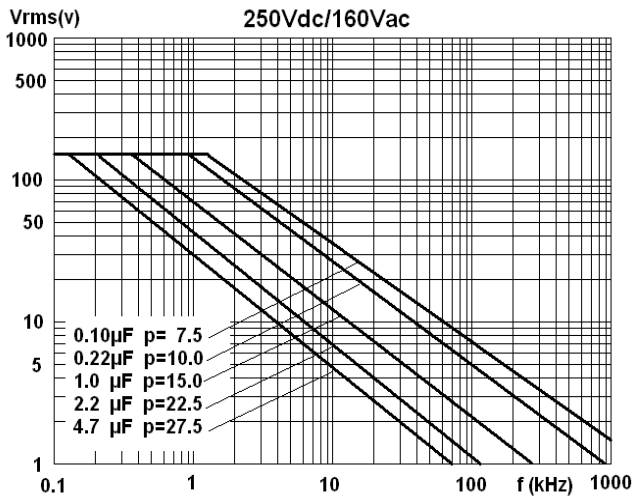
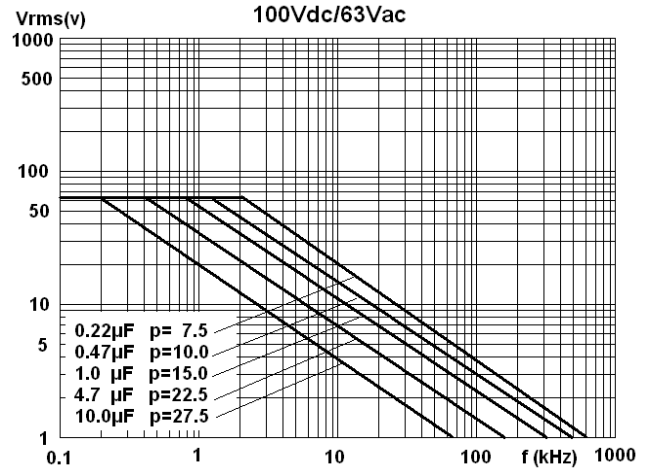
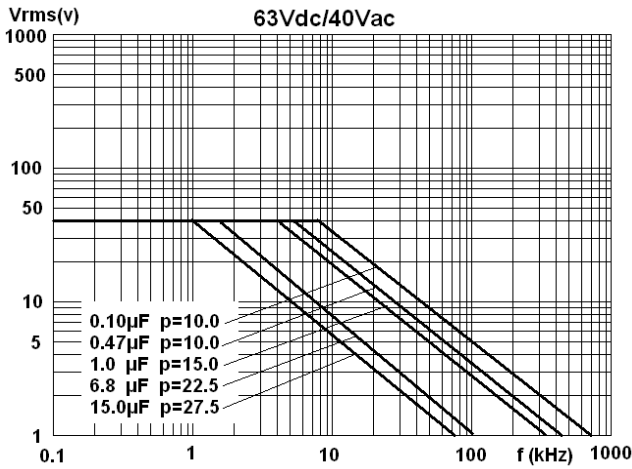

Note: sinusoidal wave-form, environment temperature $\leq 85^{\circ}\text{C}$, internal temperature rise $\Delta T=15^{\circ}\text{C}$, p (pitch) in mm..

■ Test Method And Performance

No.	Item	Performance	Test method (IEC60384-2)	
1	Solderability	Good quality of tinning	Solder temperature:245°C±5°C Immersion time: 2.0s±0.5s	
2	Initial measurement	Capacitance, Tgδ		
	Terminal strength (straight lead)	There shall be no visible damage	Ref. item 4.3 Tension: 0.6≤φd≤0.8mm, 10N φd=1.0mm, 20N Bend: 0.6≤φd≤0.8mm, 5N φd=1.0mm, 10N The terminals shall be bent 2 times in each direction.	
	Resistance to solder heat	There shall be no visible damage, legible marking	Solder temperature:260°C±5°C Immersion time: 10s±1s	
	Final measurement	ΔC/C ≤±2%(relative to the initial value) Increase of tgδ: ≤0.003 (C≤1.0μF) ≤0.002 (C>1.0μF)		
3	Initial measurement	Capacitance, Tgδ		
	Rapid change of temperature	There shall be no evidence of deterioration.	θ _A =-55°C, θ _B =+105°C 5 cycles Duration: t=30min	
	Vibration(straight lead)	There shall be no evidence of deterioration.	Amplitude 0.75mm or acceleration 98m/s ² (whichever is the smaller severity), f: 10Hz to 500Hz.Three directions, 2h for each direction, total 6h.	
	Bump(straight lead)	There shall be no evidence of deterioration.	4 000 times, Acceleration: 390m/s ² ,Pulse duration, 6ms	
	Final measurement	ΔC/C ≤±5%(relative to the initial value) Increase of tgδ: ≤0.003 (C≤1.0μF) ≤0.002 (C>1.0μF) IR: ≥ 50% of the rated value		
4	climate sequence	Initial measurement	Capacitance, Tgδ	
		Dry heat	+105°C, 16h	
		Damp heat, Cyclic	Test Db, Severity: b, the first cycle	
		Cold	-55°C, 2h	
		Low air pressure	There shall be no permanent breakdown,flashover or other harmful deformation when applying U _R at the last 1 minute.	15°C~ 35°C, 8.5kPa, 1h,
		Damp heat, cyclic other		Test Db, Severity b, the other cycles, Applying U _R for 1 minute after the test finished.

No.	Item		Performance	Test method (IEC 60384-2)
4	climate sequence (continue)	Final measurement	<p>There shall be no evidence of deterioration and the marking shall be legible.</p> <p>$\Delta C/C \leq \pm 5\%$ (relative to the initial value)</p> <p>Increase of $\text{tg}\delta$:</p> <p>≤ 0.005 ($C \leq 1.0 \mu\text{F}$)</p> <p>≤ 0.003 ($C > 1.0 \mu\text{F}$)</p> <p>IR: $\geq 50\%$ of the rated value</p>	
5	Damp heat steady state		<p>There shall be no evidence of deterioration and the marking shall be legible.</p> <p>$\Delta C/C \leq \pm 5\%$ (relative to the initial value)</p> <p>Increase of $\text{tg}\delta \leq 0.005$</p> <p>IR: $\geq 50\%$ of the rated value</p>	<p>Temperature: $40^\circ\text{C} \pm 2^\circ\text{C}$</p> <p>Humidity: $93 \pm 2\%$ RH</p> <p>Duration: 56 days</p>
6	Endurance		<p>There shall be no evidence of deterioration and the marking shall be legible.</p> <p>$\Delta C/C \leq \pm 5\%$ (relative to the initial value)</p> <p>Increase of $\text{tg}\delta$:</p> <p>≤ 0.003 ($C \leq 1.0 \mu\text{F}$)</p> <p>≤ 0.002 ($C > 1.0 \mu\text{F}$)</p> <p>IR: $\geq 50\%$ of the rated value</p>	<p>Temperature: $+85^\circ\text{C}/+100^\circ\text{C}$</p> <p>Voltage: $1.25 \times U_R / 1.25 \times U_c$ ($U_c = 0.8 U_R$)</p> <p>Duration: 2 000h</p>
7	Temperature characteristic		<p>Measuring capacitance at test point b, d, f:</p> <p>Characteristic at lower category temperature -55°C:</p> <p>$-10\% \leq (C_b - C_d) / C_d \leq 0\%$</p> <p>Characteristic at upper category temperature $+100^\circ\text{C}$:</p> <p>$0\% \leq (C_f - C_d) / C_d \leq +10\%$</p> <p>I.R. (test at point f):</p> <p>$U_R \leq 100\text{V}$: $\geq 75 \text{ M}\Omega$ ($C \leq 0.33 \mu\text{F}$)</p> <p>$\geq 25\text{s}$ ($C > 0.33 \mu\text{F}$)</p> <p>$U_R > 100\text{V}$: $\geq 150 \text{ M}\Omega$ ($C \leq 0.33 \mu\text{F}$)</p> <p>$\geq 50\text{s}$ ($C > 0.33 \mu\text{F}$)</p>	<p>Static method: The Capacitors should be kept at the following temperature in turn:</p> <p>a(20 ± 2) $^\circ\text{C}$, b(-55 ± 3) $^\circ\text{C}$, d(20 ± 2) $^\circ\text{C}$, f(100 ± 2) $^\circ\text{C}$, g(20 ± 2) $^\circ\text{C}$</p>
8	Charging and discharging		<p>$\Delta C/C \leq \pm 5\%$ (relative to the initial value)</p> <p>Increase of $\text{tg}\delta$:</p> <p>≤ 0.003 ($C \leq 1.0 \mu\text{F}$)</p> <p>≤ 0.002 ($C > 1.0 \mu\text{F}$)</p> <p>IR: $\geq 50\%$ of the rated value</p>	<p>Times: 10 000</p> <p>Duration of charging: 0.5s</p> <p>Duration of discharging: 0.5s</p> <p>Charging voltage: rated voltage</p> <p>Charging resistance: $220/C_N$ (Ω)</p> <p>Discharging resistance:</p> <p>$R = 10/C_N$ (Ω) or 20Ω (whichever is the greater)</p> <p>C_N: rated capacitance (μF)</p>

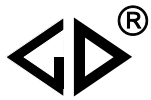

■ Marking (For example) :

 103K 630

P < 15mm

 CL23
104K 630

P ≥ 15mm

Marking Introduction:

	Brand	CL23	Type
630	Rated voltage	103 104	Rated capacitance
K	Tolerance	-	-

■ Taping specification for box-type capacitors

▲ Outline Drawing

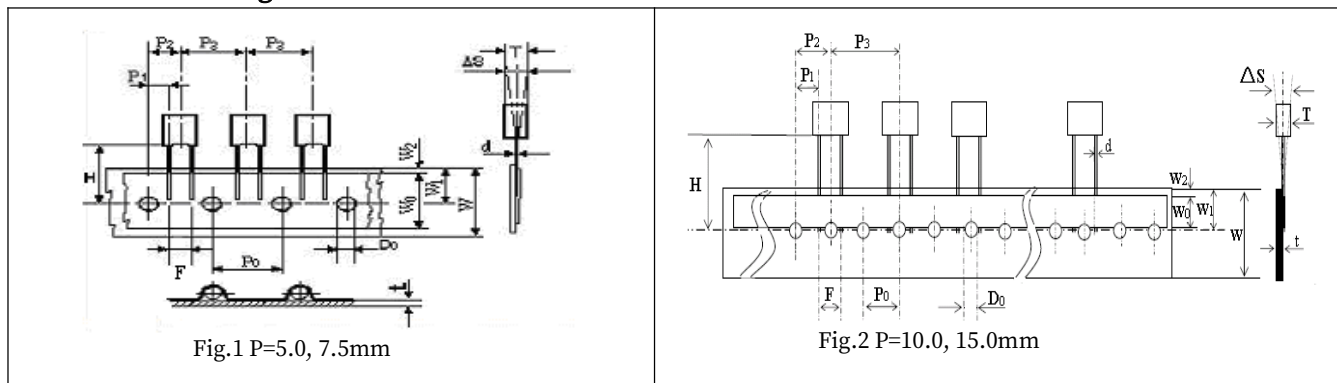

▲ Taping Dimensions(mm)

Technology index title	Code	Dimensions				Tolerance
		P=5.0	P=7.5	P=10.0	P=15.0	
Taping type	—	Fig 1	Fig 1	Fig2	Fig 2	—
Part number Digit12-15	Ammo-pack	A201	A301	A405	A605	
Taping pitch	P_3	12.7	12.7	25.4	25.4	± 1.0
Feed hole pitch	P_0	12.7	12.7	12.7	12.7	± 0.3
Center of wire	P_1	3.85	2.6	7.7	5.2	± 0.7
Center of body	P_2	6.35	6.35	12.7	12.7	± 1.3
Pitch of taping wire	F^{**}	5.0	7.5	10.0	15.0	+0.6 -0.1
Component alignment	ΔS	0	0	0	0	± 2.0
Height of component from tape center	H^{***}	18.5	18.5	18.5	18.5	± 0.5
Carrier tape width	W	18.0	18.0	18.0	18.0	+1.0 -0.5
Hold down tape width	W_0	6min	10min	10min	10min	—
Hole position	W_1	9.0	9.0	9.0	9.0	± 0.5
Hold down tape position	W_2	3max	3max	3max	3max	—
Feed hole dia.	D_0	4.0	4.0	4.0	4.0	± 0.2
Tape thickness	t	0.7	0.7	0.7	0.7	± 0.2

Note: * $P_0=15\text{mm}$ is also available;

**F can be other lead spacing;

***H=16.5mm is available;

■ Soldering suggestions

▲ Manual soldering

Max. temperature: 350°C, time: 3s

▲ Wave soldering

There are many factors affecting the heating of film capacitor during the wave soldering process, such as: preheating temperature, preheating time, soldering temperature, soldering time, other heat sources influence and so on.

The typical soldering profile is as below:

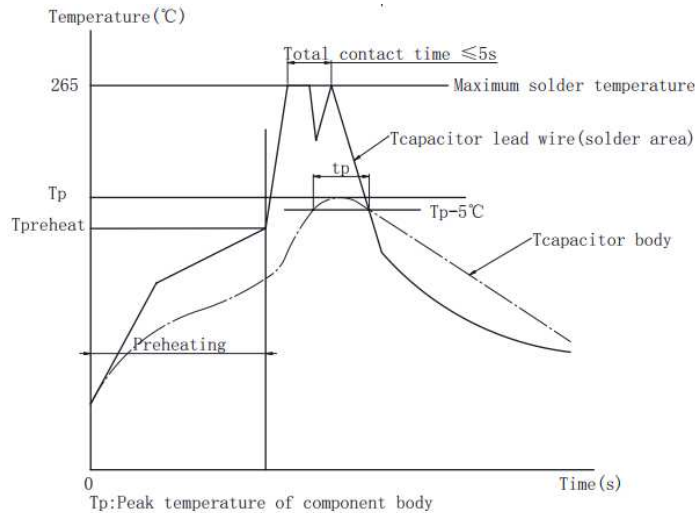

▲ Because overheating could damage the capacitor, we recommend paying attention to the maximum capacitor temperature and heating time, use temperature sensor to detect the maximum capacitor body temperature.

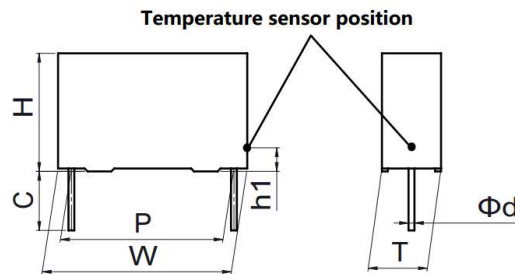

Note: If re-working or dipping twice is necessary, it should be done after the capacitor returns to the normal temperature.

Temperature sensor position (Tcapacitor body)	The capacitor body surface of lead side, capacitor height position from PCB: h1=2~3mm		
Maximum capacitor body temperature Tp(°C)	OPP film P≤15mm	OPP film P>15mm	PET film
	115	120	125
Maximum capacitor lead wire temperature(°C)	265	265	265
Maximum capacitor body heating time tp=Tp-5°C	30s		

■ Packing box sizes(mm)(example)

1. Out packing box for bulk

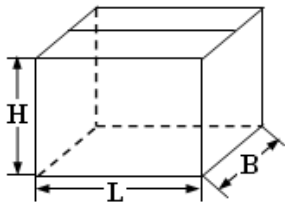

L:375±5
B:375±5
H:265±5

2. Inner packing box for bulk

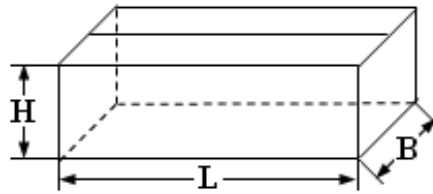

L:355±3
B:175±3
H:118±3

3. Box sizes for Ammo-pack

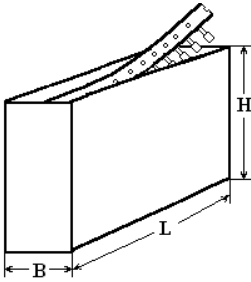

L: 350 ± 3
B: 50 ± 3
H: 260 ± 3

■ Storage conditions

▲ It must be noted that the solderability of the terminals may be deteriorated when stored in an atmosphere filled with moisture, dust, or a reactive oxidizing gas.(hydrogen chloride, hydrogen sulfide, sulfuric acid,etc.)

▲ It shouldn't be located in particularly high temperature and high humidity, it must submit to the following conditions(unchanging primal package):

Temperature: -40 °C to 35 °C

Humidity: Average per year ≤70%RH;

For 30 full days randomly distributed throughout the year ≤80%RH

Storage time for tinned lead wire: (from the date marked on the capacitor's body or the label glued to the package) :

Bulk(packed with plastic bag): ≤24 months ;

Taping and line up: ≤12 months