

GENERAL FEATURES

V_{DS}	$R_{DS(ON)}$ Typ	I_D MAX
-250V	7.7Ω@-10V	-0.27A

Application

- Load/Power Switching
- Interfacing Switching
- Logic Level Shift

Package and Pin Configuration

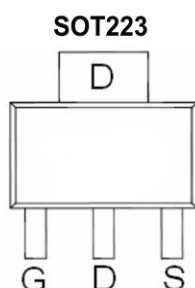

Circuit diagram

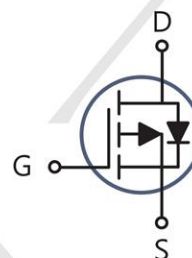

Marking:

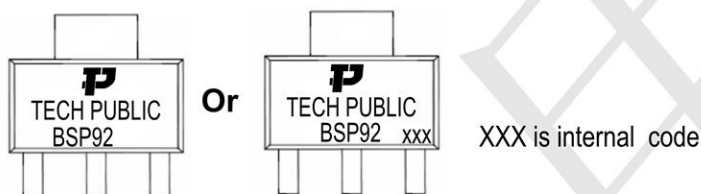

ABSOLUTE MAXIMUM RATINGS ($T_C=25^{\circ}C$ unless otherwise noted)

Parameter	Symbol	Limit	Units	
Drain-Source Voltage	V_{DS}	-250	V	
Gate-Source Voltage	V_{GS}	±20	V	
Drain Current-Continuous (Note 2)	I_D	$T_A=25^{\circ}C$	-0.27	A
		$T_A=70^{\circ}C$	-0.25	A
- Pulsed (Note 1、Note 2)	I_{DM}	-1.1	A	
Single Pulse Avalanche Energy (Note 3)	EAS	10	mJ	
Maximum Power Dissipation	$T_A=25^{\circ}C$	1.8	W	
Operating Junction and Storage Temperature Range	T_J, T_{STG}	-55 to 150	$^{\circ}C$	

THERMAL CHARACTERISTICS

Thermal Resistance, Junction-to-Ambient	$R_{\theta JA}$	160	$^{\circ}C/W$
---	-----------------	-----	---------------

ELECTRICAL CHARACTERISTICS ($T_C=25^\circ\text{C}$ unless otherwise noted)

Parameter	Symbol	Test Conditions	Min	Typ	Max	Units
-----------	--------	-----------------	-----	-----	-----	-------

OFF CHARACTERISTICS

Drain-Source Breakdown Voltage	BV_{DSS}	$V_{GS}=0V, I_D=-250\mu A$	-250			V
Zero Gate Voltage Drain Current	I_{DSS}	$V_{DS}=-200V, V_{GS}=0V$			-1	μA
Gate-Body Leakage Current	I_{GSS}	$V_{GS}=\pm 20V, V_{DS}=0V$			± 100	nA

ON CHARACTERISTICS

Gate Threshold Voltage	$V_{GS(th)}$	$V_{DS}=V_{GS}, I_D=-250\mu A$	-1	-1.5	-3	V
Drain-Source On-State Resistance	$R_{DS(ON)}$	$V_{GS}=-10V, I_D=-0.1A$		7.7	9.6	ohm
		$V_{GS}=-4.5V, I_D=-0.1A$		8	10	ohm
Forward Transconductance	g_{FS}	$V_{DS}=10V, I_D=-0.1A$		1.5		S

DYNAMIC CHARACTERISTICS (Note 4)

Input Capacitance	C_{ISS}	$V_{DS}=-100V, V_{GS}=0V$ $f=1.0MHz$		229		pF
Output Capacitance	C_{OSS}			16.7		pF
Reverse Transfer Capacitance	C_{RSS}			8.8		pF
Total Gate Charge	Q_g	$V_{DS}=-100V, I_D=-0.3A, V_{GS}=-10V$		4.1		nC
Gate-Source Charge	Q_{gs}	$V_{DS}=-100V, I_D=-0.1A,$ $V_{GS}=-10V$		0.7		nC
Gate-Drain Charge	Q_{gd}			0.8		nC

SWITCHING CHARACTERISTICS (Note 4)

Turn-On Delay Time	$t_{D(ON)}$	$V_{DD}=-100V$ $I_D=-0.1A$ $V_{GS}=-10V$ $R_{GEN}=6\text{ ohm}$		0.9		ns
Rise Time	t_r			0.7		ns
Turn-Off Delay Time	$t_{D(OFF)}$			9.9		ns
Fall Time	t_f			4.7		ns

DRAIN-SOURCE DIODE CHARACTERISTICS AND MAXIMUM RATINGS

Diode Forward Voltage	V_{SD}	$V_{GS}=0V, I_S=-1A$		-0.85	-1.3	V
-----------------------	----------	----------------------	--	-------	------	---

Typical Electrical and Thermal Characteristics

Figure 1. Output Characteristics

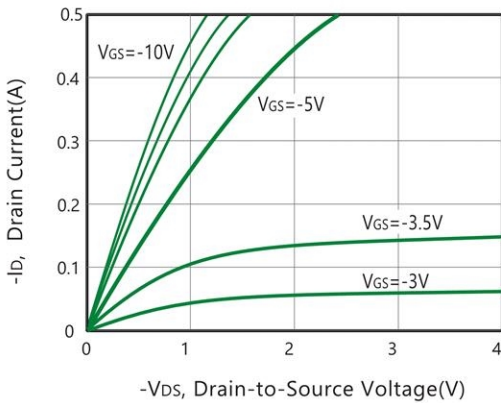

Figure 2. Body Diode Forward Voltage Variation with Source Current

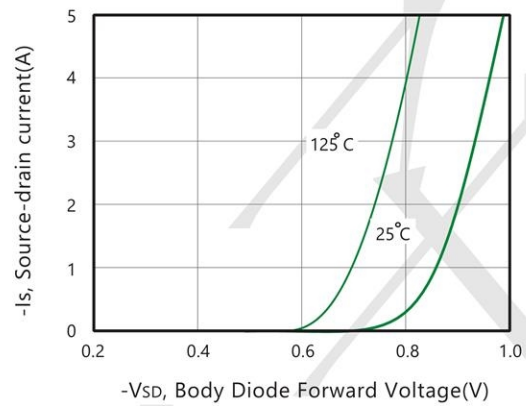

Figure 3. On-Resistance vs. Gate-Source Voltage

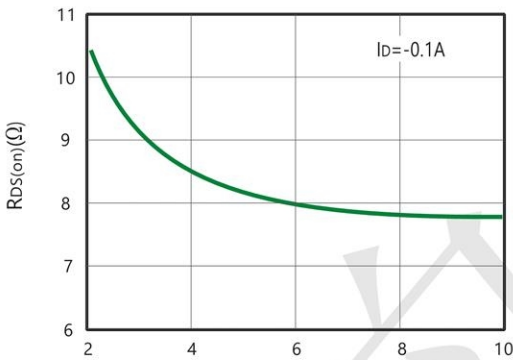

Figure 4. On-Resistance Variation with Drain Current and Temperature

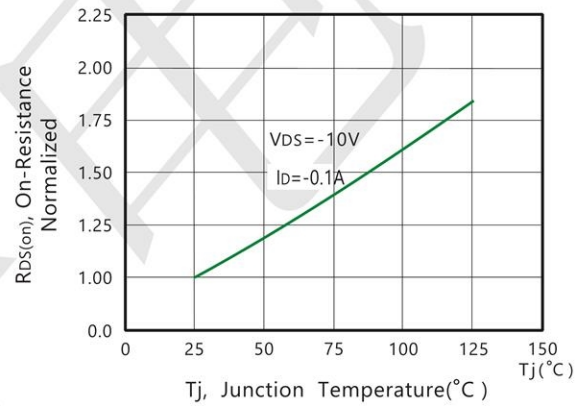

Figure 5. Gate Threshold Variation with Temperature

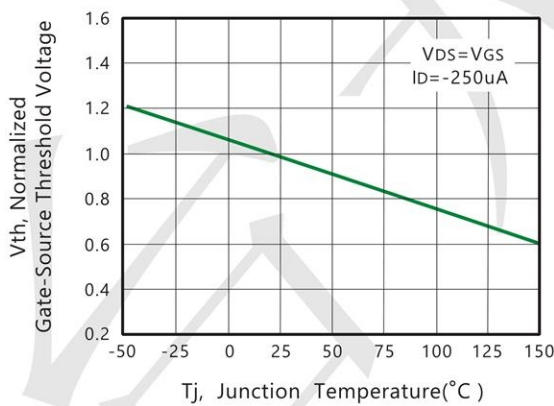

Figure 6. Gate Charge

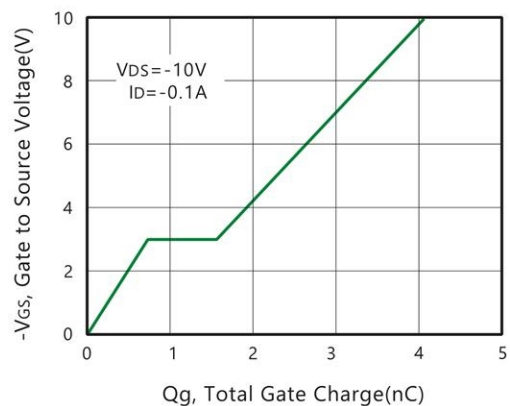

Figure 7. Capacitance

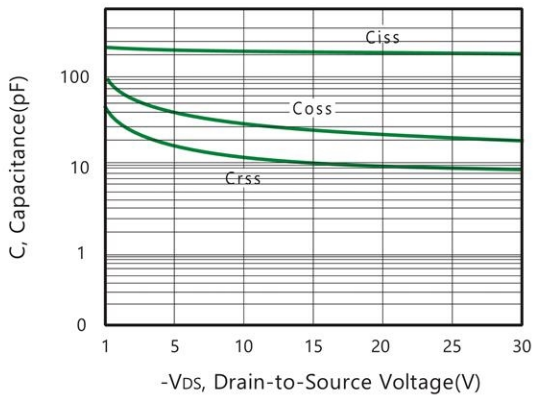

Figure 8. Maximum Safe Operating Area

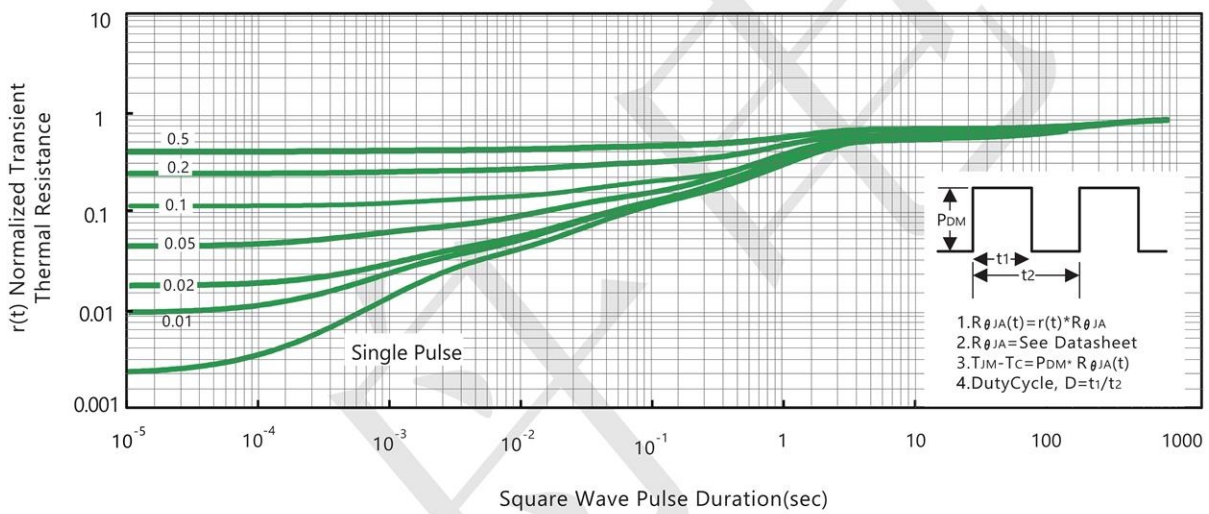
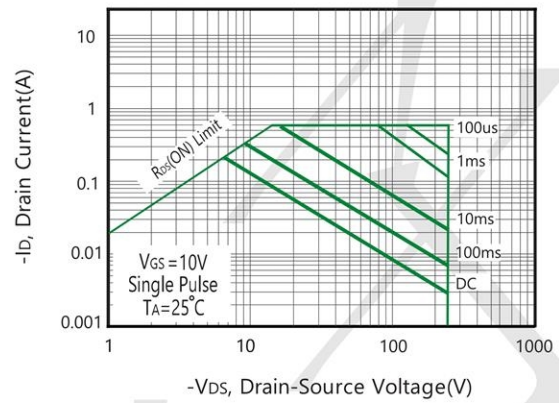

Figure 9. Normalized Thermal Transient Impedance Curve

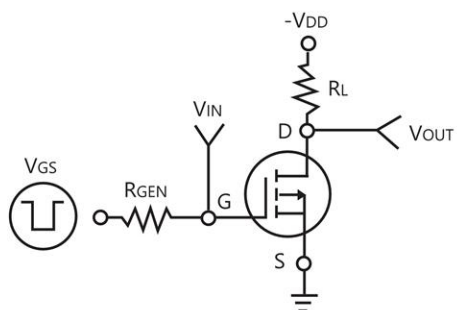

Figure 10a. Switching Test Circuit

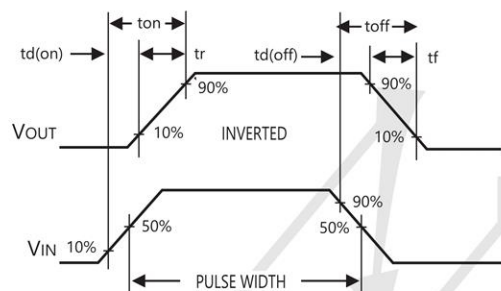
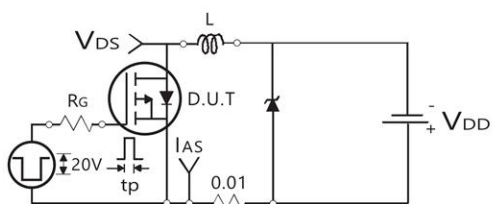
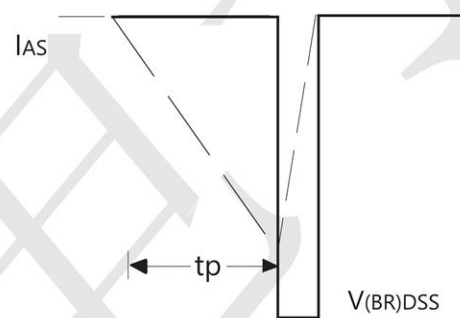

Figure 10b. Switching Waveforms



Unclamped Inductive Test Circuit

Figure 11a.



Unclamped Inductive Waveforms

Figure 11b.

SOT-223 Package Information

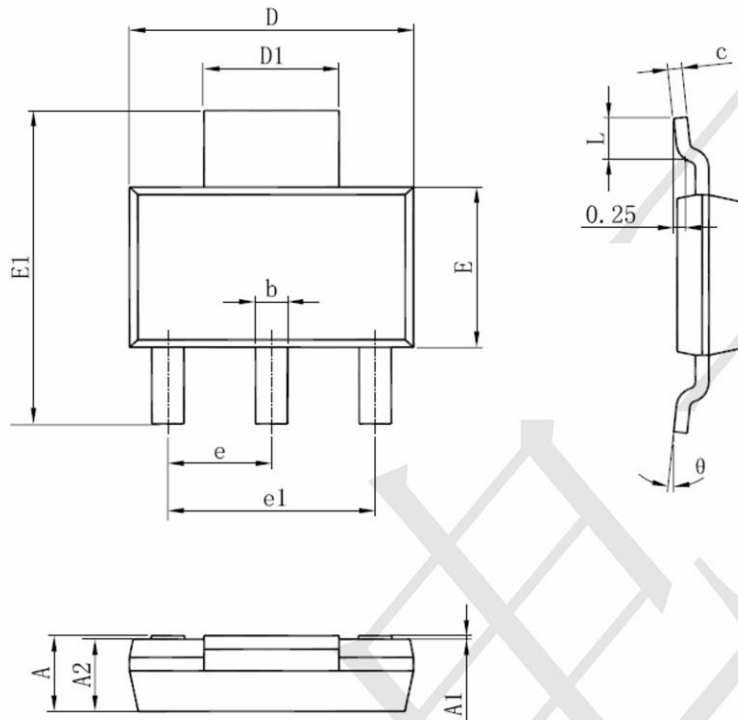

Symbol	Dimensions In Millimeters		Dimensions In Inches	
	Min	Max	Min	Max
A	1.520	1.800	0.060	0.071
A1	0.000	0.100	0.000	0.004
A2	1.500	1.700	0.059	0.067
b	0.660	0.820	0.026	0.032
c	0.250	0.350	0.010	0.014
D	6.200	6.400	0.244	0.252
D1	2.900	3.100	0.114	0.122
E	3.300	3.700	0.130	0.146
E1	6.830	7.070	0.269	0.278
e	2.300(BSC)		0.091(BSC)	
e1	4.500	4.700	0.177	0.185
L	0.900	1.150	0.035	0.045
θ	0°	10°	0°	10°