

General Features

- $V_{DS}=30V$ $I_D=6A$
- $R_{DS(ON)} < 23m\Omega$, $V_{GS}@10V$,
- $R_{DS(ON)} < 32m\Omega$, $V_{GS}@4.5V$,

Application

- Load/Power Switching
- Interfacing Switching
- Battery Management for Ultra Small Portable Electronics
- Logic Level Shift

Package and Pin Configuration

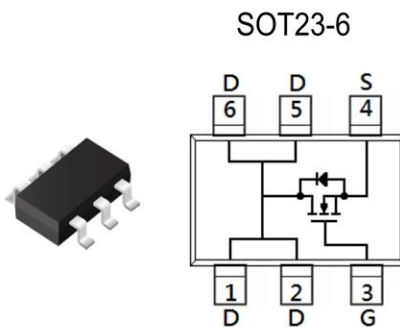

Block Diagram

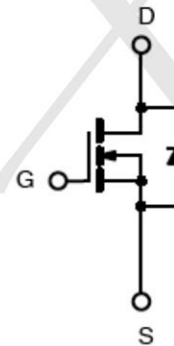

- “**P**” is TECH PUBLIC Logo
- “**6N**” is Part number, fixed
- “**HY**” is internal code

Absolute Maximum Ratings ($T_A=25^\circ C$ unless otherwise noted)

| PARAMETER | SYMBOL | LIMIT | UNITS | |
|--|-----------------|---------------------------|--------------|----------------|
| Drain-Source Voltage | V_{DS} | 30 | V | |
| Gate-Source Voltage | V_{GS} | ± 20 | | |
| Continuous Drain Current (Note 4) | I_D | 6 | A | |
| Pulsed Drain Current (Note 1) | I_{DM} | 25 | | |
| Power Dissipation | P_D | $T_a=25^\circ C$ | 2 | W |
| | | Derate above $25^\circ C$ | 16 | mW/ $^\circ C$ |
| Operating Junction and Storage Temperature Range | T_J, T_{STG} | -55~150 | $^\circ C$ | |
| Typical Thermal Resistance | $R_{\theta JA}$ | 62.5 | $^\circ C/W$ | |
| - Junction to Ambient (Note 3) | | | | |

| Parameter | Conditions | Symbol | Min | Typ | Max | Unit |
|---|--|--------------|-----|------|-----------|------------|
| Static | | | | | | |
| Drain-Source Breakdown Voltage | $V_{GS} = 0V, I_D = 250\mu A$ | BV_{DSS} | 30 | -- | -- | V |
| Drain-Source On-State Resistance | $V_{GS} = 10V, I_D = 6A$ | $R_{DS(on)}$ | -- | 18 | 23 | m Ω |
| | $V_{GS} = 4.5V, I_D = 4A$ | | -- | 22 | 32 | |
| Gate Threshold Voltage | $V_{DS} = V_{GS}, I_D = 250\mu A$ | $V_{GS(TH)}$ | 1.0 | 1.5 | 2.5 | V |
| Zero Gate Voltage Drain Current | $V_{DS} = 30V, V_{GS} = 0V$ | I_{DSS} | -- | -- | 1 | μA |
| | $V_{DS} = 24V, T_J = 125^\circ C$ | | -- | -- | 10 | |
| Gate Body Leakage | $V_{GS} = \pm 20V, V_{DS} = 0V$ | I_{GSS} | -- | -- | ± 100 | μA |
| Forward Transconductance ^(Note 3) | $V_{DS} = 10V, I_D = 4A$ | g_{fs} | -- | 6.5 | -- | S |
| Dynamic | | | | | | |
| Total Gate Charge ^(Note 3,4) | $V_{DS} = 15V, I_D = 6A,$ $V_{GS} = 4.5V$ | Q_g | -- | 4.1 | -- | nC |
| Gate-Source Charge ^(Note 3,4) | | Q_{gs} | -- | 1 | -- | |
| Gate-Drain Charge ^(Note 3,4) | | Q_{gd} | -- | 2.1 | -- | |
| Input Capacitance | $V_{DS} = 25V, V_{GS} = 0V,$ $f = 1.0MHz$ | C_{iss} | -- | 345 | -- | pF |
| Output Capacitance | | C_{oss} | -- | 55 | -- | |
| Reverse Transfer Capacitance | | C_{rss} | -- | 32 | -- | |
| Switching | | | | | | |
| Turn-On Delay Time ^(Note 3,4) | $V_{DD} = 15V, I_D = 1A,$ $V_{GS} = 10V, R_G = 6\Omega$ | $t_{d(on)}$ | -- | 2.8 | -- | ns |
| Turn-On Rise Time ^(Note 3,4) | | t_r | -- | 7.2 | -- | |
| Turn-Off Delay Time ^(Note 3,4) | | $t_{d(off)}$ | -- | 15.8 | -- | |
| Turn-Off Fall Time ^(Note 3,4) | | t_f | -- | 4.6 | -- | |
| Source-Drain Diode Ratings and Characteristic | | | | | | |
| Maximum Continuous Drain-Source Diode Forward Current | Integral reverse diode in the MOSFET | I_S | -- | -- | 6 | A |
| Maximum Pulse Drain-Source Diode Forward Current | | I_{SM} | -- | -- | 25 | A |
| Diode-Source Forward Voltage | $V_{GS} = 0V, I_S = 1A$ | V_{SD} | -- | -- | 1 | V |

Note:

1. Pulse width limited by safe operating area
2. $L = 1mH, I_{AS} = 8A, V_{DD} = 25V, R_G = 25\Omega,$ Starting $T_J = 25^\circ C$
3. Pulse test: pulse width $\leq 300\mu s,$ duty cycle $\leq 2\%$
4. Switching time is essentially independent of operating temperature.

Typical Electrical and Thermal Characteristics (Curves)

Continuous Drain Current vs. T_C

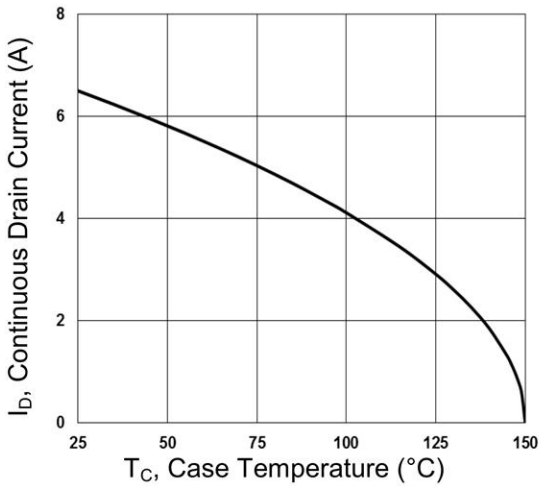

Gate Charge

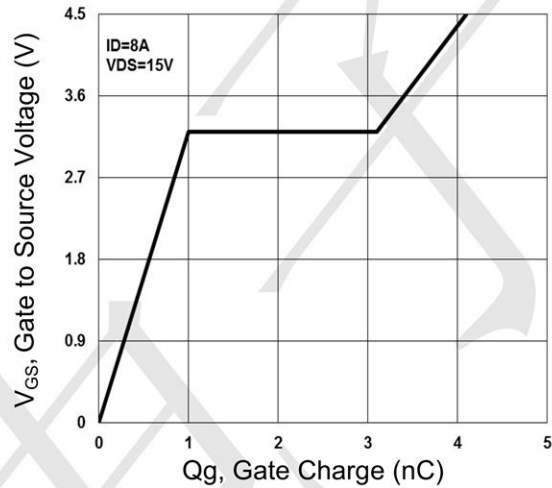

On-Resistance vs. Junction Temperature

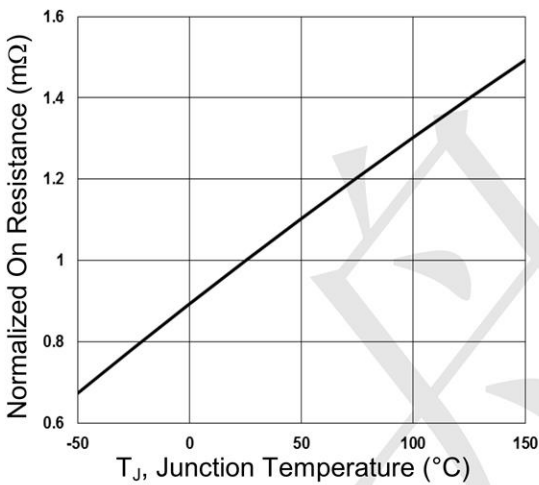

Threshold Voltage vs. Junction Temperature

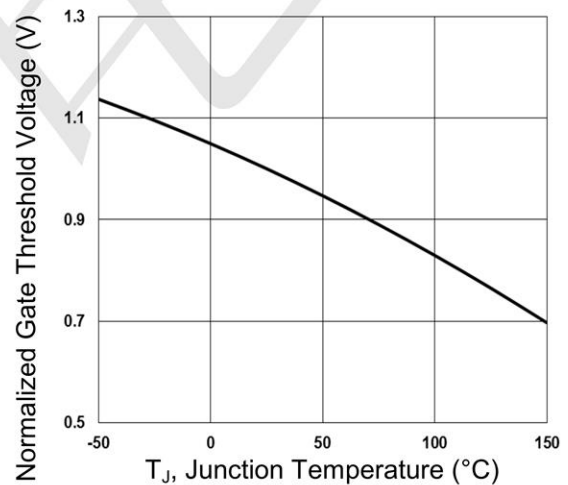

Maximum Safe Operating Area

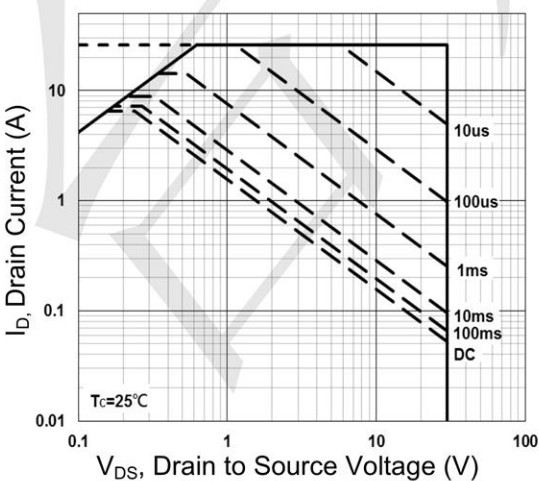

Normalized Thermal Transient Impedance Curve

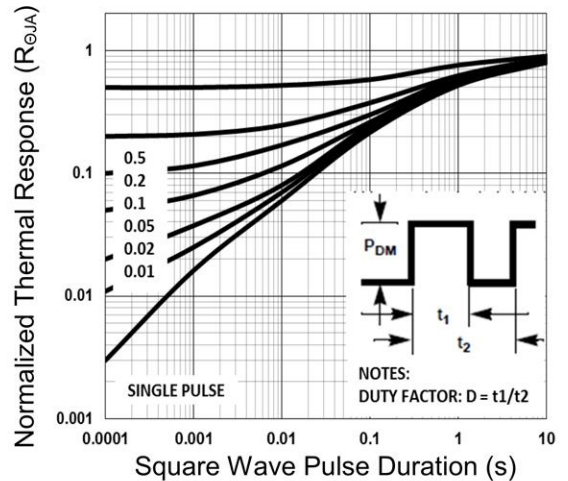



SOT23-6 Package Information

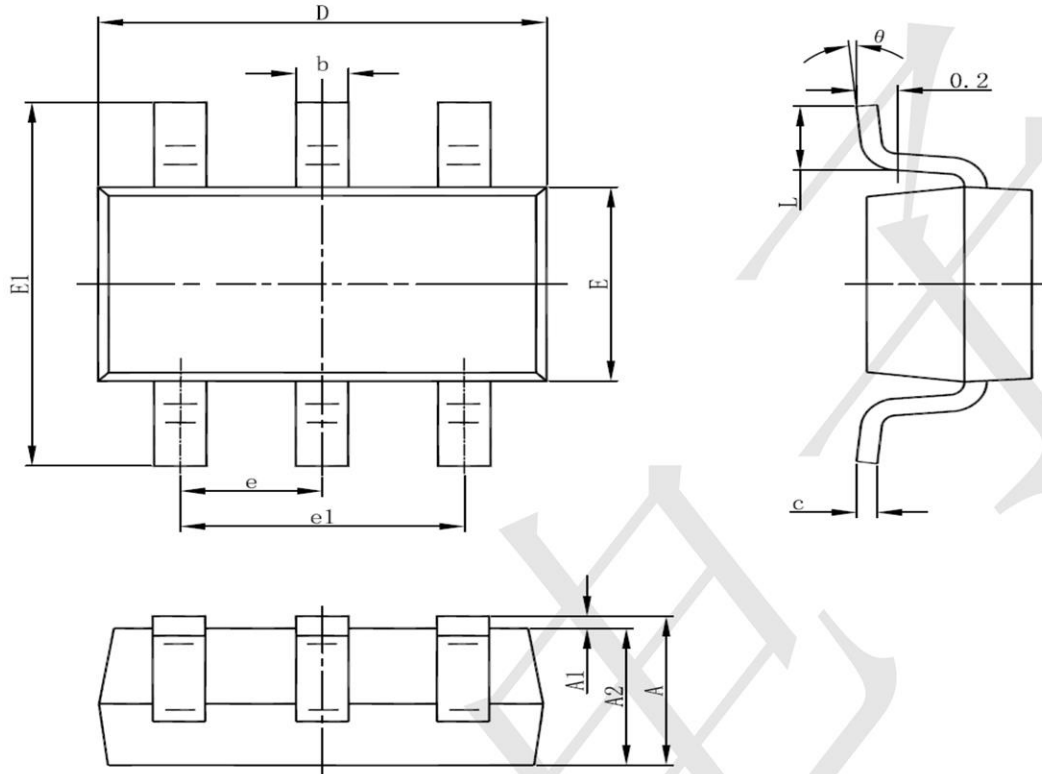

| Symbol | Dimensions In Millimeters | | Dimensions In Inches | |
|--------|---------------------------|-------|----------------------|-------|
| | Min | Max | Min | Max |
| A | 1.050 | 1.250 | 0.041 | 0.049 |
| A1 | 0.000 | 0.100 | 0.000 | 0.004 |
| A2 | 1.050 | 1.150 | 0.041 | 0.045 |
| b | 0.300 | 0.500 | 0.012 | 0.020 |
| c | 0.100 | 0.200 | 0.004 | 0.008 |
| D | 2.820 | 3.020 | 0.111 | 0.119 |
| E | 1.500 | 1.700 | 0.059 | 0.067 |
| E1 | 2.650 | 2.950 | 0.104 | 0.116 |
| e | 0.950(BSC) | | 0.037(BSC) | |
| e1 | 1.800 | 2.000 | 0.071 | 0.079 |
| L | 0.300 | 0.600 | 0.012 | 0.024 |
| θ | 0° | 8° | 0° | 8° |