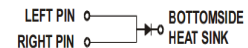
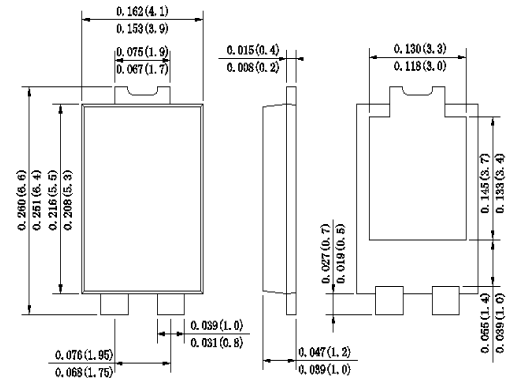

SURFACE MOUNT SCHOTTKY BARRIER RECTIFIER

Features

- ◆ Planar MOS Schottky barrier diodes
- ◆ Low forward voltage drop
- ◆ low profile - typical body height 1.1 mm Moisture
- ◆ sensitivity: level 1, per J-STD-020
- ◆ High temperature soldering guaranteed: 260 °C/ 10 seconds
- ◆ RoHS Compliant
- ◆ Halogen-free according to IEC 61249-2-21 definition

TO-277

Dimensions in inches and (millimeters)

Mechanical Data

- Case** : JEDEC TO-277 Molded plastic body
 Case Material: Molding compound meets UL 94V-0 flammability rating
- Terminals** :Plated Leads Solderable per MIL-STD-202,Method 208
- Polarity** : Polarity symbol marking on body
- Mounting Position** : Any
- Weight** : 0.003 ounce, 0.092 grams

Maximum Ratings And Electrical Characteristics

Ratings at 25°C ambient temperature unless otherwise specified.

Single phase half-wave 60Hz, resistive or inductive load, for capacitive load current derate by 20%.

Parameter	SYMBOL	SL1545		UNIT
		MDD SL1545		
Marking Code				
Maximum repetitive peak reverse voltage	V_{RRM}	45		V
Maximum DC blocking voltage	V_{DC}			
RMS Reverse voltage	V_{RMS}	31.5		V
Average Rectified Output Current	$I_{(O)}$	15		A
Non-Repetitive Peak Forward Surge 8.3ms Single Half Sine-Wave Superimposed on rated load (JEDEC Method)	I_{FSM}	250		A
Typical Junction Capacitance (note1)	C_J	1000		pF

Electrical Characteristics $T_a=25^\circ\text{C}$ unless otherwise noted

Parameter	Test Conditions	Symbol	Value		Unit
			Typ	Max	
Forward Voltage Drop at 15A	$T_A=25^\circ\text{C}$	V_F	--	0.48	V
	$T_A=100^\circ\text{C}$		--	0.43	
Peak reverse current at rated DC blocking voltage	$T_A=25^\circ\text{C}$	I_R	100	200	uA
	$T_A=100^\circ\text{C}$		10	20	
Typical thermal resistance(note2)		$R_{\theta JA}$	22		°C/W
Operating junction storage temperature range		T_J	-55 to +150		°C
Storage temperature range		T_{STG}	-55 to +150		°C

note:1.Measured at 1.0 MHz and applied reverse voltage of 4.0Vdc

2.Polyimide PCB, 2oz. Copper. Cathode pad dimensions 18.8* 14.4*1.6mm. Anode pad dimensions 5.6 x 14.4*1.6mm.



Ratings And Characteristic Curves

FIG.1-TYPICAL FORWARD CURRENT DERATING CURVE

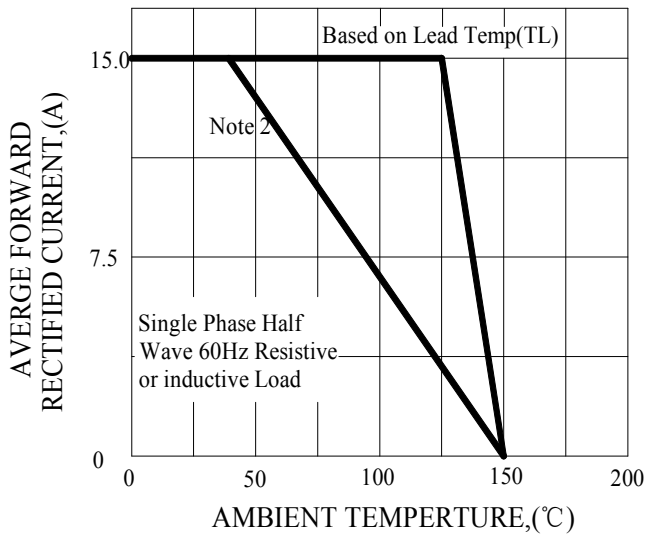

FIG.2-TYPICAL INSTANTANEOUS FORWARD CHARACTERISTICS

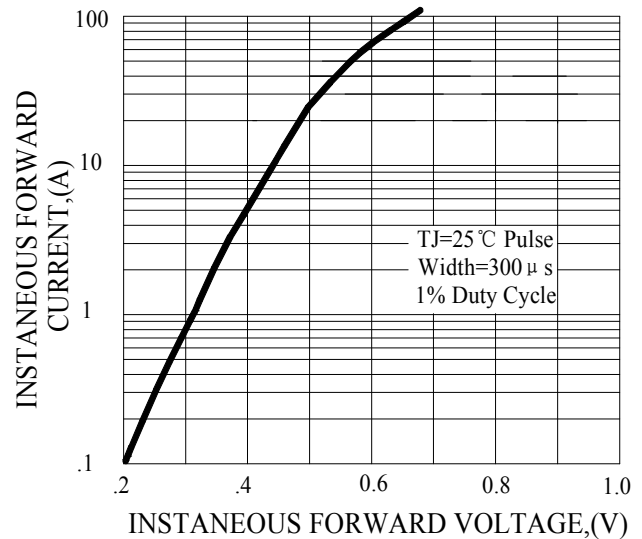

FIG.3-MAXIMUM NON-REPETITIVE FORWARD SURGE CURRENT

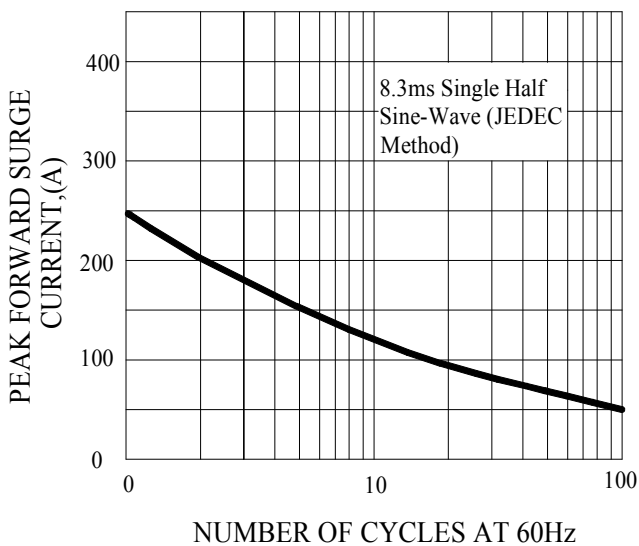
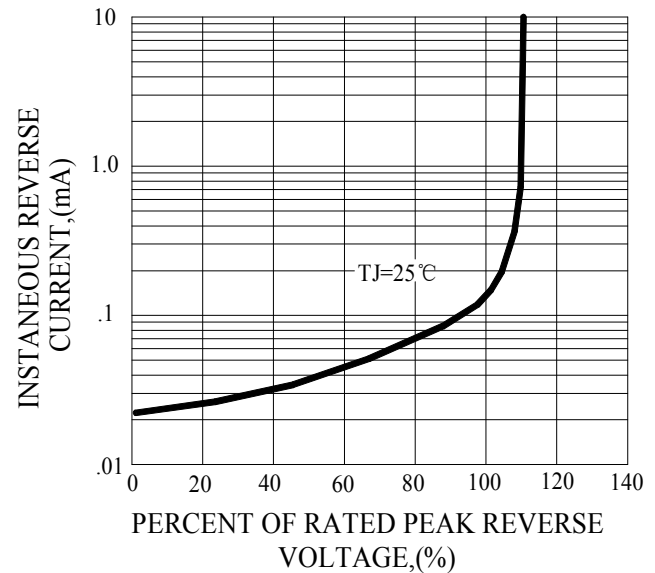
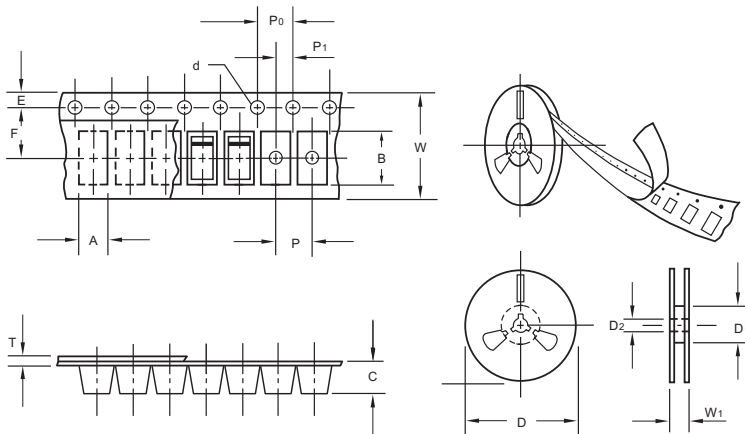

FIG.4-TYPICAL REVERSE CHARACTERISTICS



The curve above is for reference only.

Packing information



unit:mm

Item	Symbol	Tolerance	TO-277
Carrier width	A	0.1	4.45
Carrier length	B	0.1	7.0
Carrier depth	C	0.1	1.60
Sprocket hole	d	0.05	1.55
13" Reel outside diameter	D	2.0	330.00
13" Reel inner diameter	D1	min	50.0
Feed hole diameter	D2	0.5	13.00
Sprocket hole position	E	0.1	1.75
Punch hole position	F	0.1	7.50
Punch hole pitch	P	0.1	8.00
Sprocket hole pitch	P0	0.1	4.00
Embossment center	P1	0.1	2.00
Overall tape thickness	T	0.1	0.25
Tape width	W	0.3	12.00
Reel width	W1	1.0	12.30

Note: Devices are packed in accordance with EIA standard RS-481-A and specifications listed above.

Reel packing

PACKAGE	REEL SIZE	REEL (pcs)	COMPONENT SPACING (m/m)	BOX (pcs)	INNER BOX (m/m)	REEL DIA, (m/m)	CARTON SIZE (m/m)	CARTON (pcs)	APPROX. GROSS WEIGHT (kg)
TO-277	13"	5,000	4.0	10,000	210*208*203	330	430*430*235	80,000	13.0

Suggested Pad Layout

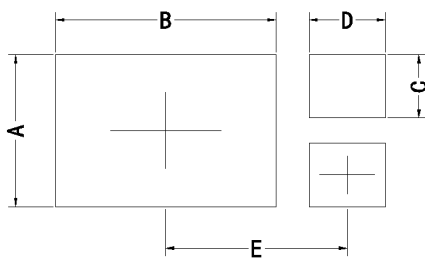

Symbol	Unit (mm)	Unit (inch)
A	3.60	0.142
B	5.35	0.211
C	1.50	0.059
D	1.85	0.073
E	4.30	0.169