

RoHS Compliant

REV.	ECN NO.	DESCRIPTION	DATE	DESIGN
A0.	/	新版发行	20.04.03	yang
A1.	/	重新核对图面	20.01.07	LiHui

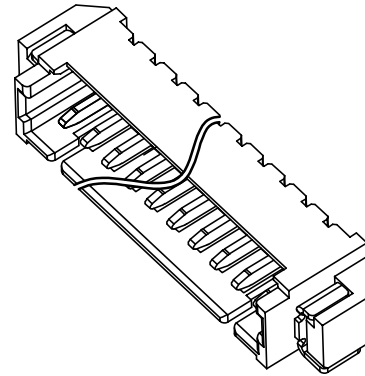

3D VIEW

PIN数	A±0.15	B±0.15	C±0.15
13P	21.35	18.25	15.00
14P	22.60	19.50	16.25
15P	23.85	20.75	17.50
16P	25.10	22.00	18.75

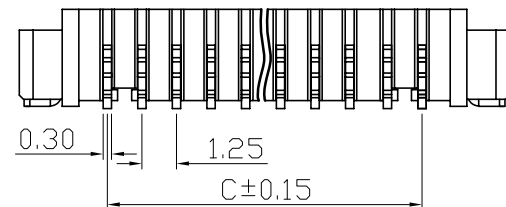
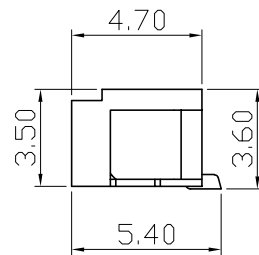
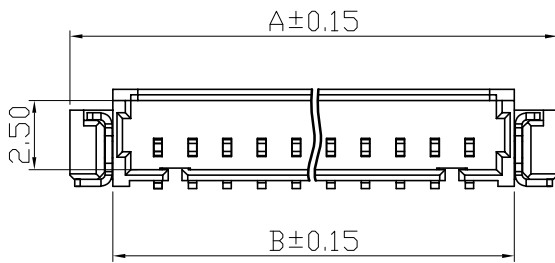
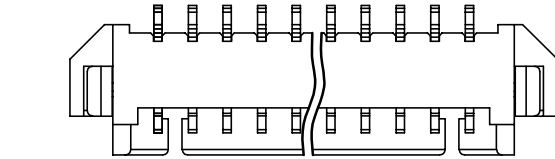

Specifications:

1. Rated Voltage : 125V AC/DC
2. Rated Current : 1A AC,DC
3. Withstand Voltage : 200V AC/minute
4. Contact Resistance : 50mΩ(MAX.)
5. Insulation Resistance : 100MΩ(MIN.)
6. Storage Temperature Range: -40°C~+85°C;
7. Operation Temperature Range: -25°C~+70°C;

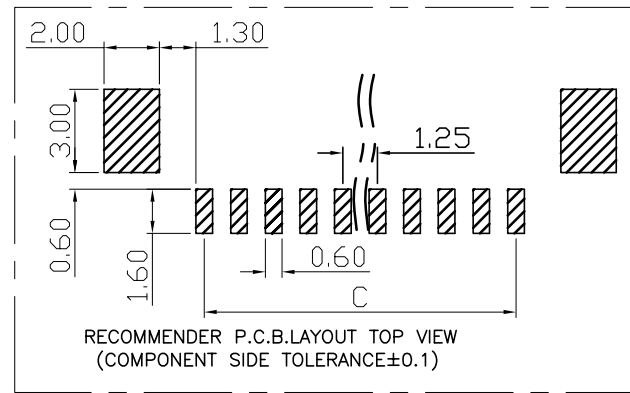
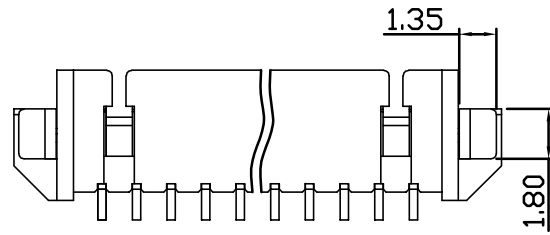

C	插片	黄铜+65	镀镍锡	
B	插针	黄铜+65	镀镍锡	
A	基座	LCP	本色	
序号	品名	材质	电镀/颜色	备注

深圳市虹成电子有限公司

UNLESS OTHERWISE, GENERAL TOLERANCE: X. xxx ±0.05 X. xx ±0.15 X. x ±0.25	NAME:	P/N: HCZZ0001-14			
	针座1.25卧贴	DWG NO:			
THIRD ANGLE PROJECTION	UNIT:	SCALE	SIZE:	SHEET:	REV.
	MM	1:1	A4	1/1	A1
ANGULAR: X. xx° ±1° X. x° ±3° X. ° ±5°	DRAWN:	CHECKED:	APPROVED:		