



### Main

Range of Product	Telemecanique Limit switches XC Standard
Series name	Miniature format
Product or Component Type	Wireless limit switch
Device short name	XCMW
Sensor design	Miniature
Body type	Fixed
Head type	Rotary head

### Complementary

Body Material	Plastic
Head material	Metal
Lever material	Metal
Fixing Mode	By 2 screws
Type of operator	Spring return roller lever elastomer roller diameter 50 mm
Switch actuation	By 30° cam
Type of approach	Lateral approach, 2 directions
Communication network type	ZigBee green power 2.4 GHz IEEE 802.15.4
Electrical composition code	PW1
Emission Power	3 mW
Response Time	<= 2 ms
Maximum sensing distance	328.08 Ft (100 m) in free field 984.25 Ft (300 m) with external antenna 82.02 ft (25 m) in industrial environment
Contact operation	Snap action
Number of steps	1
Maximum torque for tripping	4.43 lbf.in (0.5 N.m)
Maximum actuation speed	0.33 ft/s (0.1 m/s)
Maximum operating rate	60 cyc/mn
Mechanical durability	400000 cycles
Switching operation per hour	3600
Width	1.18 in (30.0 mm)
Height	4.25 in (108 mm)
Depth	0.63 in (16.0 mm)
Net Weight	0.19 lb(US) (0.088 kg)

## Environment

Electromagnetic compatibility	Radiated emission Immunity for industrial environments Susceptibility to electromagnetic fields 3 V/m 80...2700 MHz, distance = 20 m) Susceptibility to electromagnetic fields 10 V/m 80...2000 MHz) Electrostatic discharge immunity test 6 kV on contact (on metal parts)) Electrostatic discharge immunity test 8 kV in free air (in insulating parts))
Shock resistance	50 gn 11 ms IEC 60068-2-27
Vibration resistance	+/- 10 mm 2...11 Hz)IEC 60068-2-6 25 gn 10...500 Hz)IEC 60068-2-6
IP degree of protection	IP65 conforming to IEC 60529
IK degree of protection	IK04 EN 50102
Ambient air temperature for operation	-13...131 °F (-25...55 °C)
Ambient Air Temperature for Storage	-40...158 °F (-40...70 °C)
Directives	1999/5/EC - R&TTE directive 2004/108/EC - electromagnetic compatibility
Standards	EN/IEC 60947-1 EN/IEC 60947-5-1
Radio agreement	IC RSS FCC RCM

## Ordering and shipping details

Category	22412 - LIMIT SWITCHES,IEC,XCKW WIRELESS
Discount Schedule	T
GTIN	3389119643955
Nbr. of units in pkg.	1
Package weight(Lbs)	3.67 oz (104 g)
Returnability	Yes

## Packing Units

Unit Type of Package 1	PCE
Package 1 Height	1.26 in (3.2 cm)
Package 1 width	1.85 in (4.7 cm)
Package 1 Length	5.00 in (12.7 cm)
Unit Type of Package 2	S01
Number of Units in Package 2	22
Package 2 Weight	5.43 lb(US) (2.464 kg)
Package 2 Height	5.91 in (15 cm)
Package 2 width	5.91 in (15 cm)
Package 2 Length	15.75 in (40 cm)

## Offer Sustainability

Sustainable offer status	Green Premium product
California proposition 65	WARNING: This product can expose you to chemicals including: Diisononyl phthalate (DINP), which is known to the State of California to cause cancer, and Di-isodecyl phthalate (DIDP), which is known to the State of California to cause birth defects or other reproductive harm. For more information go to <a href="http://www.P65Warnings.ca.gov">www.P65Warnings.ca.gov</a>
REACH Regulation	<a href="#">REACH Declaration</a>
EU RoHS Directive	Pro-active compliance (Product out of EU RoHS legal scope) <a href="#">EU RoHS Declaration</a>
Mercury free	Yes
RoHS exemption information	<a href="#">Yes</a>
Environmental Disclosure	<a href="#">Product Environmental Profile</a>
Circularity Profile	<a href="#">End Of Life Information</a>

Dimensions

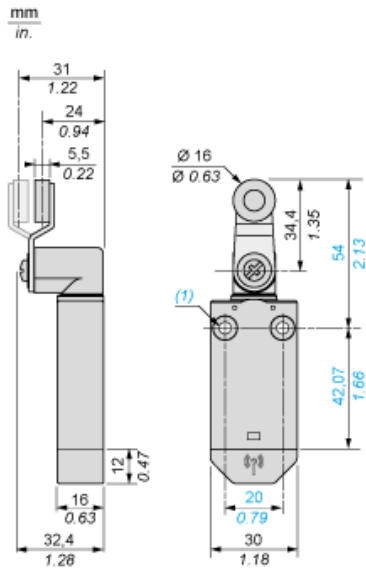

(1) : 2 fixing holes  $\varnothing 4.2$  mm ( $\varnothing 0.17$  in.)

Screw Mounting

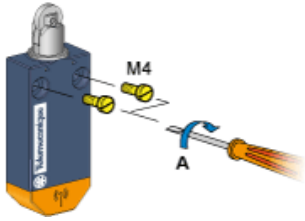

A = 1 Nm  $\pm 0.1$   
A = 8.85 lb.in.  $\pm 0.89$

Unobstructed Mounting

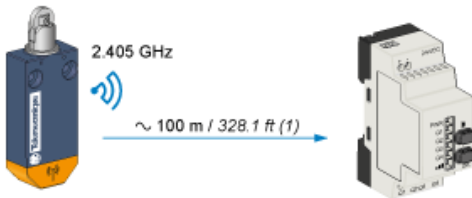

(1) : Typical values that may be modified by the application environment.

Mounting in a Metal Cabinet

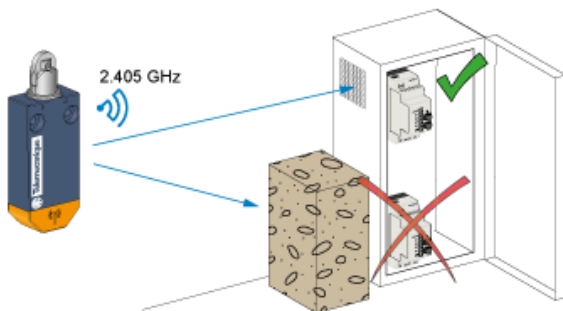

Signal Attenuation According to the Material

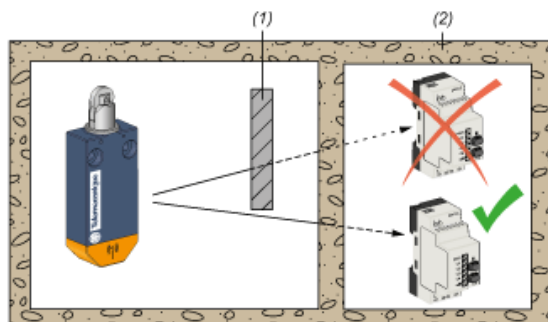

(1) : Metal structure  
(2) : Wall  
(3) : Values for indication purposes only

NOTE: Actual values depend on the thickness and nature of the material.

Material	Signal attenuation (%)
Glass window	10...20% (3)
Plaster wall	20...45% (3)
Brick wall	60% (3)
Concrete wall	70...80% (3)
Metal structure	50...100% (3)

## Mounting Tips for Antenna

### Optimized Installation

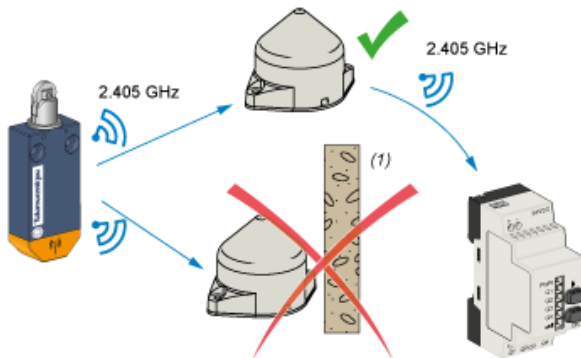

(1): Obstacle

### The Relay Antenna is used to Bypass an Obstacle and/or Increase the Range

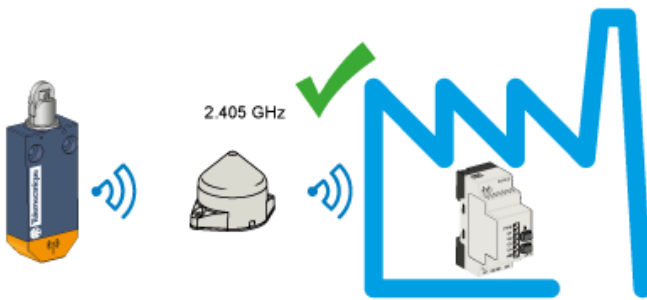

### Mounting with roller lever



---

Characteristics of Actuation

---

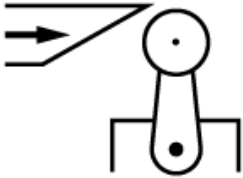

---

Technical Description

---

Functional Diagram, Travel Distance



- (1): Reset
- (2): Set