

FEATURES

- Guaranteed 1.5A Peak Current
- Low Quiescent Current
- Low Dropout Voltage of 280mV at 1A
- Extremely Tight Load and Line Regulation
- Extremely Fast Transient Response
- Reverse-battery Protection
- Internal Thermal Protection
- Internal Short Circuit Current Limit
- Replacement for LM2940, MIC2940A, AS2940
- Standard TO-220 and TO-263 packages

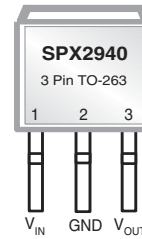

Now Available in Lead Free Packaging

APPLICATIONS

- Powering VGA & Sound Card
- LCD Monitors
- USB Power Supply
- Power PC™ Supplies
- SMPS Post-Regulator
- PDA or Notebook Computer
- High Efficiency Linear Power Supplies
- Portable Instrumentation
- Constant Current Regulators
- Cordless Telephones
- Automotive Electronics

DESCRIPTION

The SPX2940 is a 1A, accurate voltage regulators with a low drop out voltage of 280mV (typical) at 1A. These regulators are specifically designed for low voltage applications that require a low dropout voltage and a fast transient response. They are fully fault protected against over-current, reverse battery, and positive and negative voltage transients.

The SPX2940 is offered in 3-pin TO-220 & TO-263 packages. For a 3A version, refer to the SPX29300 data sheet.

TYPICAL APPLICATIONS CIRCUIT

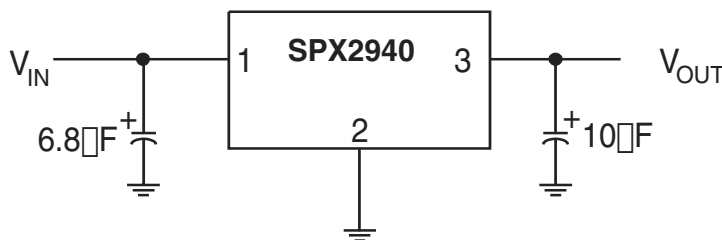

Figure 1. Fixed Output Linear Regulator.

ABSOLUTE MAXIMUM RATINGS

Lead Temperature (soldering, 5 seconds)	260°C
Storage Temperature Range	-65°C to +150°C
Operating Junction Temperature Range	-40°C to +125°C
Input Voltage (Note 5)	16V

ELECTRICAL CHARACTERISTICS

at $V_{IN} = V_{OUT} + 1V$ and $I_{OUT} = 10mA$, $C_{IN} = 6.8\mu F$, $C_{OUT} = 10\mu F$; $T_A = 25^\circ C$, unless otherwise specified. The Boldface applies over the junction temperature range. Adjustable versions are set at 5.0V.

PARAMETER	CONDITIONS	TYP	MIN	MAX	UNITS
1.8V Version					
Output Voltage	$I_{OUT} = 10mA$ $10mA \leq I_{OUT} \leq 1A$, $6V \leq V_{IN} \leq 16V$	1.8 1.8	1.746 1.710	1.854 1.890	V
2.5V Version					
Output Voltage	$I_{OUT} = 10mA$ $10mA \leq I_{OUT} \leq 1A$, $6V \leq V_{IN} \leq 16V$	2.5 2.5	2.425 2.375	2.575 2.625	V
3.3V Version					
Output Voltage	$I_{OUT} = 10mA$ $10mA \leq I_{OUT} \leq 1A$, $6V \leq V_{IN} \leq 16V$	3.3 3.3	3.201 3.135	3.399 3.465	V
5.0V Version					
Output Voltage	$I_{OUT} = 10mA$ $10mA \leq I_{OUT} \leq 1A$, $6V \leq V_{IN} \leq 16V$	5.0 5.0	4.850 4.750	5.150 5.250	V
All Voltage Options					
Line Regulation	$I_O = 10mA$, $(V_{OUT} + 1V) \leq V_{IN} \leq 16V$	0.2		1.0	%
Load Regulation	$V_{IN} = V_{OUT} + 1V$, $10mA \leq I_{OUT} \leq 1A$	0.3		1.5	%
$\frac{\Delta V}{\Delta T}$	Output Voltage Temperature Coef.	20		100	ppm/°C
Dropout Voltage (Note 1) (except 1.8V version)	$I_O = 100mA$	70		200	mV
	$I_O = 1A$	280		550	
Ground Current (Note 3)	$I_O = 750mA$, $V_{IN} = V_{OUT} + 1V$	12		25	mA
	$I_O = 1A$	18			
I_{GNDDO} Ground Pin Current at Dropout	$V_{IN} = 0.1V$ less than specified V_{OUT} $I_{OUT} = 10mA$	1.2			mA
Current Limit	$V_{OUT} = 0V$ (Note 2)	2.2	1.5		A
Output Noise Voltage 10Hz to 100kHz) $I_L = 100mA$	$C_L = 10\mu F$	400			μV_{RMS}
	$C_L = 33\mu F$	260			
Thermal Resistance	TO-220 Junction to Case, at Tab	3			°C/W
	TO-220 Junction to Ambient	60			
	TO-263 Junction to Case, at Tab	3			
	TO-263 Junction to Ambient	60			

NOTES:

Note 1: Dropout voltage is defined as the input to output differential when the output voltage drops to 99% of its normal value.

Note 2: $V_{IN} = V_{OUT (NOMINAL)} + 1V$. For example, use $V_{IN} = 4.3V$ for a 3.3V regulator. Employ pulse-testing procedures to minimize temperature rise.

Note 3: Ground pin current is the regulator quiescent current. The total current drawn from the source is the sum of the load current to the ground current.

Note 4: Thermal regulation is defined as the change in the output voltage at a time T after a change in power dissipation is applied, excluding load or line regulation effects.

Note 5: Maximum positive supply voltage of 20V must be of limited duration (<100ms) and duty cycle (<1%). The maximum continuous supply voltage is 16V.

BLOCK DIAGRAM

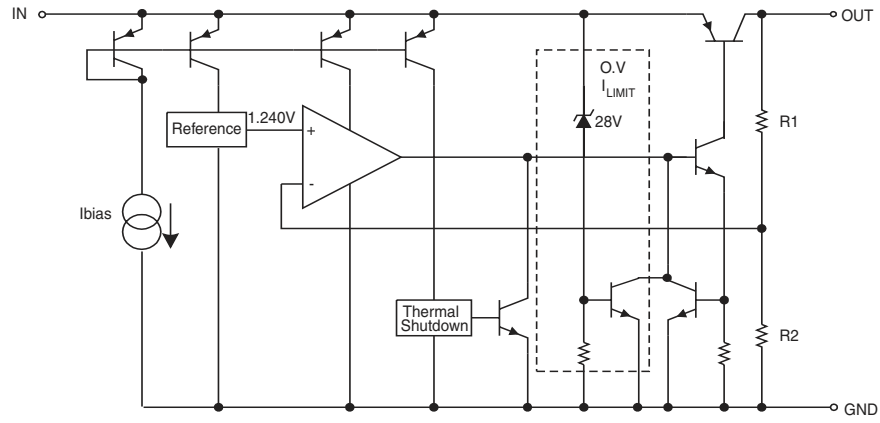

TYPICAL PERFORMANCE CHARACTERISTICS

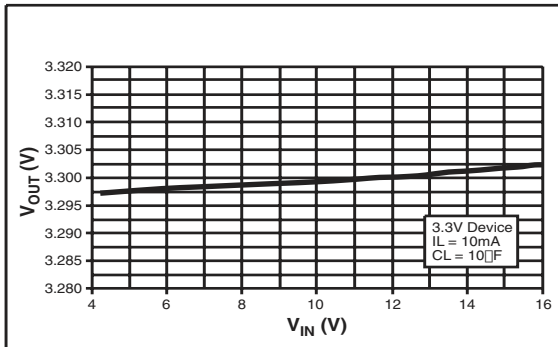

Figure 2. Line Regulation

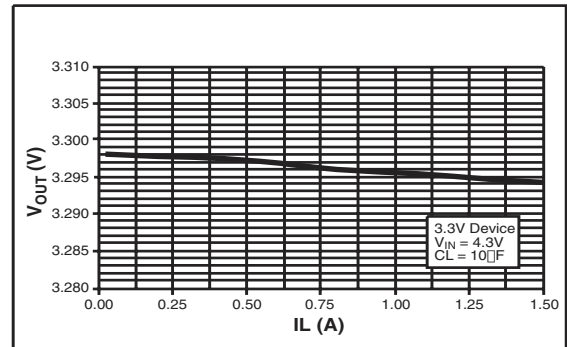

Figure 3. Load Regulation

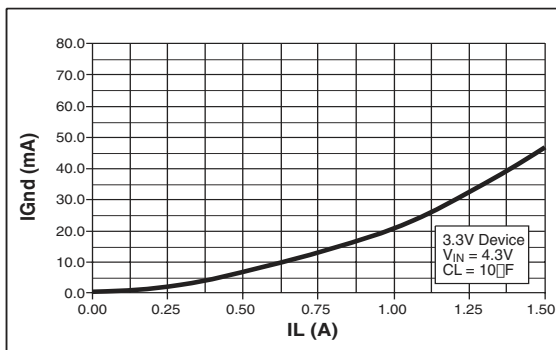

Figure 4. Ground Current vs Load Current

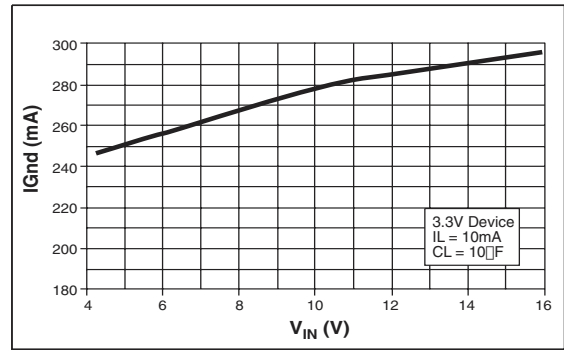

Figure 5. Ground Current vs Input Voltage

TYPICAL PERFORMANCE CHARACTERISTICS

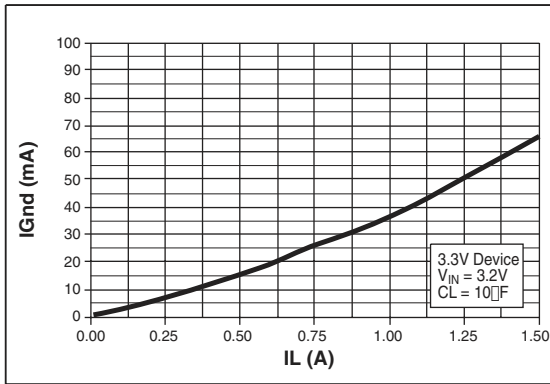

Figure 6. Ground Current vs Current in Dropout

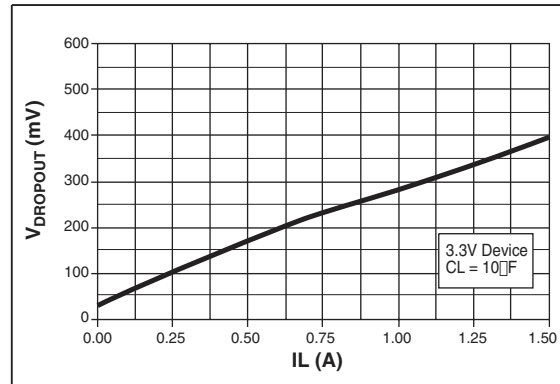

Figure 7. Dropout Voltage vs Load Current

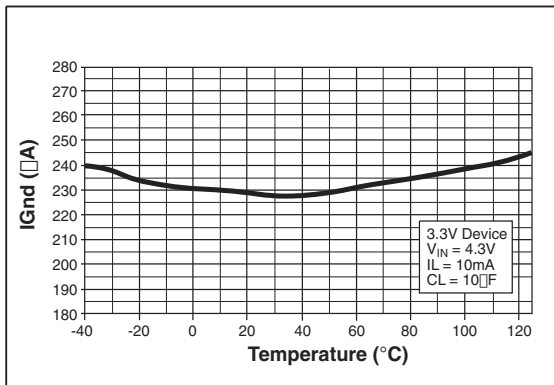

Figure 8. Ground Current vs Temperature at $I_{LOAD} = 10mA$

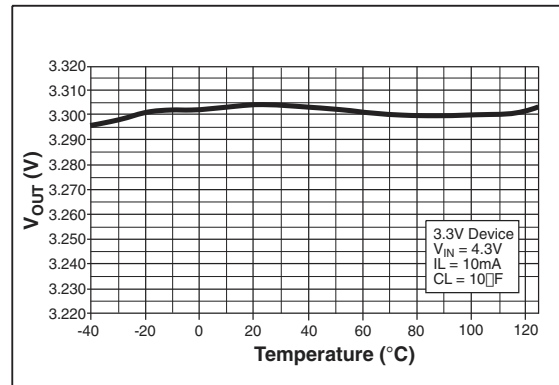

Figure 9. Output Voltage vs Temperature at $I_{LOAD} = 10mA$

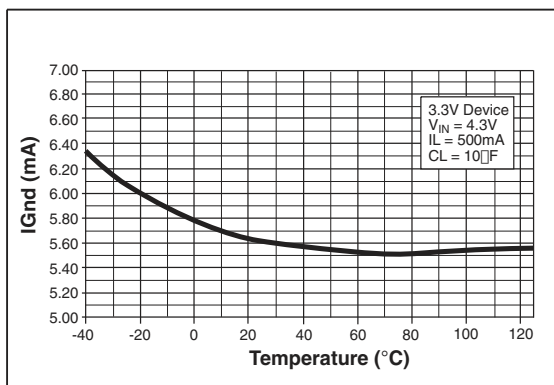

Figure 10. Ground Current vs Temperature at $I_{LOAD} = 500mA$

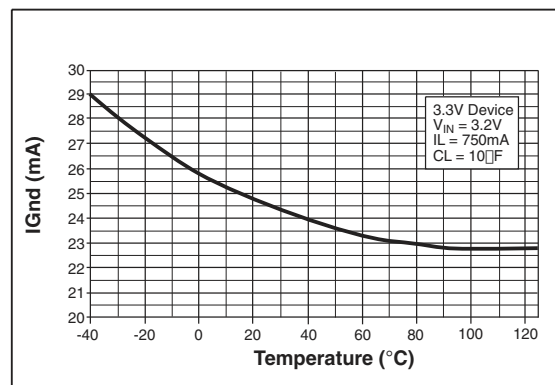

Figure 11. Ground Current vs Temperature in Dropout at $I_{LOAD} = 750mA$

TYPICAL PERFORMANCE CHARACTERISTICS

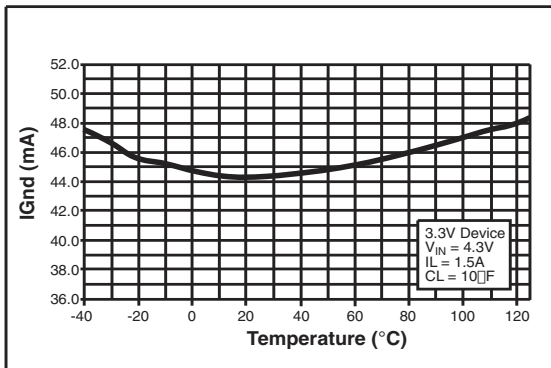

Figure 12. Ground Current vs Temperature at $I_{LOAD} = 1.5A$

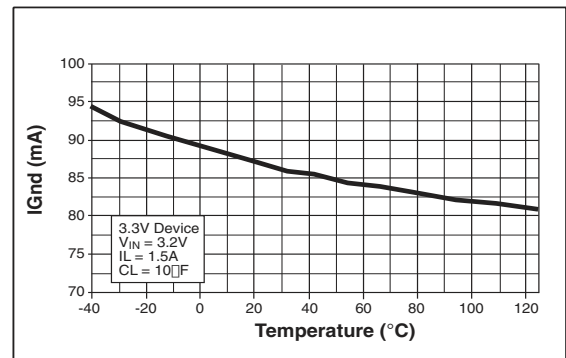

Figure 13. Ground Current vs Temperature in Dropout at $I_{LOAD} = 1.5A$

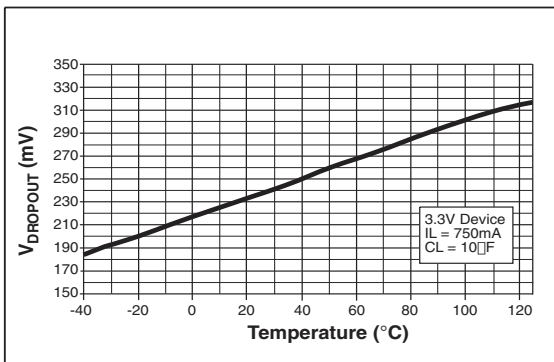

Figure 14. Dropout Voltage vs Temperature at $I_{LOAD} = 750mA$

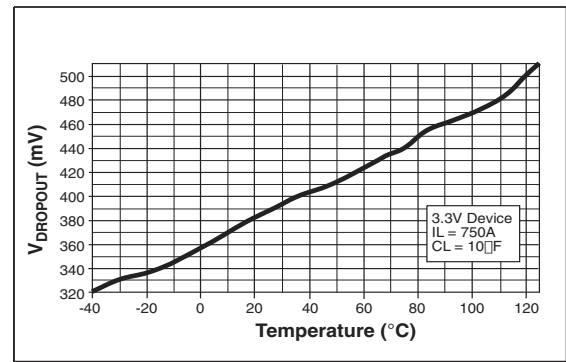

Figure 15. Dropout Voltage vs Temperature at $I_{LOAD} = 1.5mA$

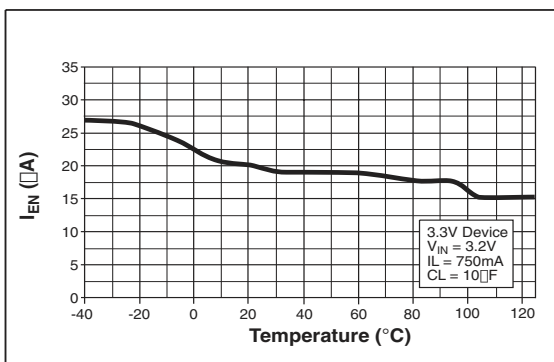

Figure 16. Enable Current vs Temperature for $V_{EN} = 16V$

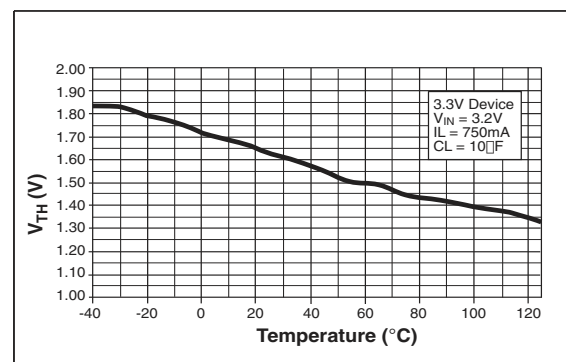

Figure 17. Enable Threshold vs Temperature

APPLICATION INFORMATION

The SPX2940 incorporates protection against over-current faults, reversed load insertion, over temperature operation, and positive and negative transient voltage.

Thermal Considerations

Although the SPX2940 offers limiting circuitry for overload conditions, it is still necessary to insure that the maximum junction temperature is not exceeded in the application. Heat will flow through the lowest resistance path, the junction-to-case path. In order to insure the best thermal flow of the component, proper mounting is required. Consult heatsink manufacturer for thermal resistance and design of heatsink.

For example, TO-220 design:

Assume that $V_{IN} = 10V$, $V_{OUT} = 5V$, $I_{OUT} = 1.5A$, $T_A = 50^{\circ}C/W$, $\theta_{HA} = 1^{\circ}C/W$, $\theta_{CH} = 2^{\circ}C/W$, and $\theta_{JC} = 3^{\circ}C/W$.

Where T_A = ambient temperature

θ_{HA} = heatsink to ambient thermal resistance

θ_{CH} = case to heatsink thermal resistance

θ_{JC} = junction to case thermal resistance

The power calculated under these conditions is:

$$P_D = (V_{IN} - V_{OUT}) * I_{OUT} = 7.5W.$$

And the junction temperature is calculated as

$$T_J = T_A + P_D * (\theta_{HA} + \theta_{CH} + \theta_{JC}) \text{ or}$$

$$T_J = 50 + 7.5 * (1 + 2 + 3) = 95^{\circ}C$$

Reliable operation is insured.

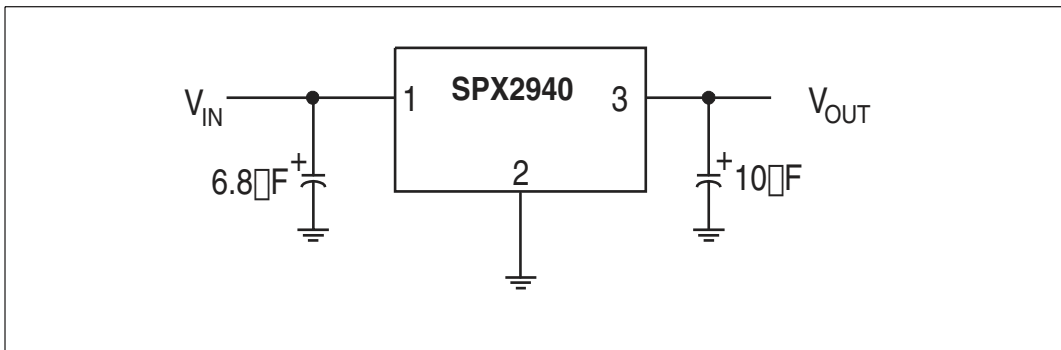

Figure 18. Fixed Output Linear Regulator.

Capacitor Requirements

The output capacitor is needed to insure stability and minimize the output noise. The value of the capacitor varies with the load. However, a minimum value of 10µF aluminum capacitor will guarantee stability over all load conditions. A tantalum capacitor is recommended if a faster load transient response is needed.

If the power source has a high AC impedance, a 0.1µF ceramic capacitor between input & ground is recommended.

Minimum Load Current

To ensure a proper behavior of the regulator under light load, a minimum load of 5mA for SPX2940 is required.

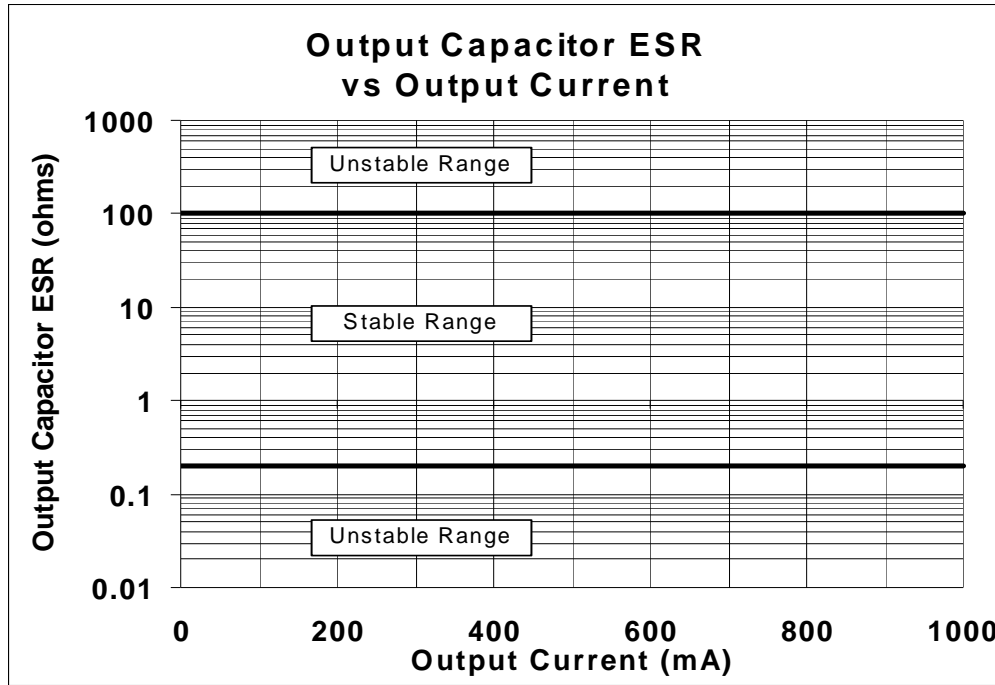

Figure 19. Output Cap ESR vs. I_{out} .

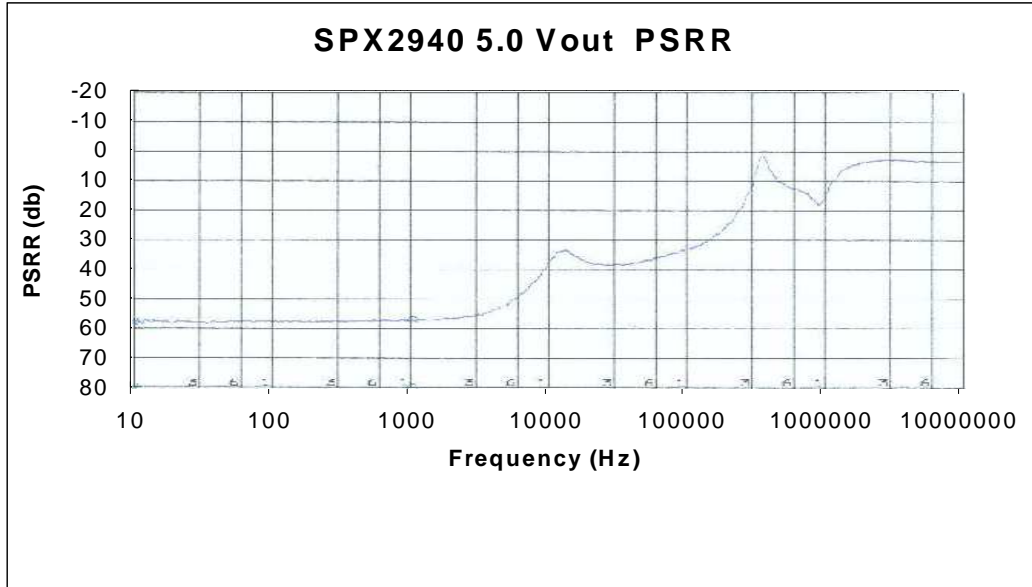
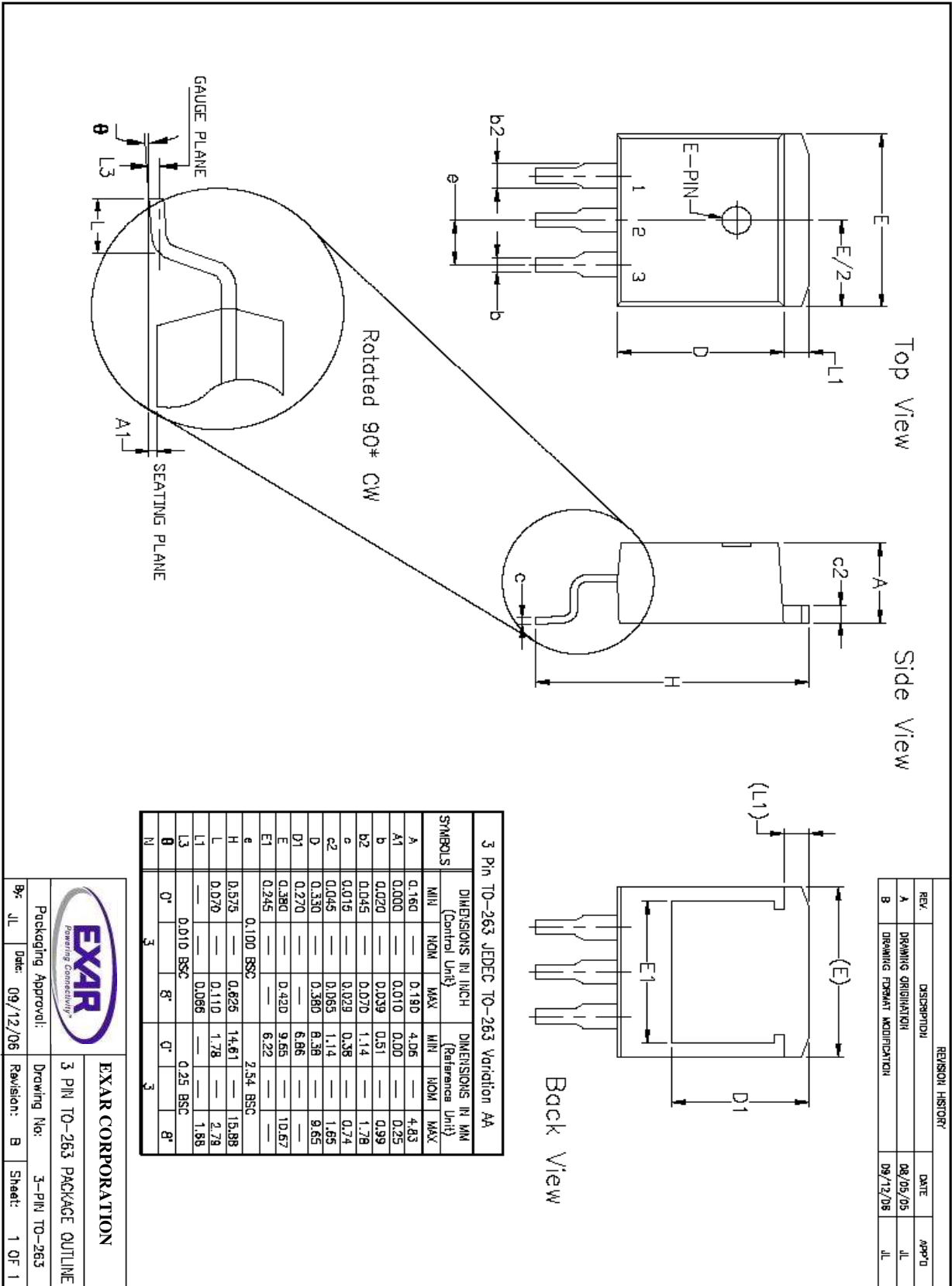
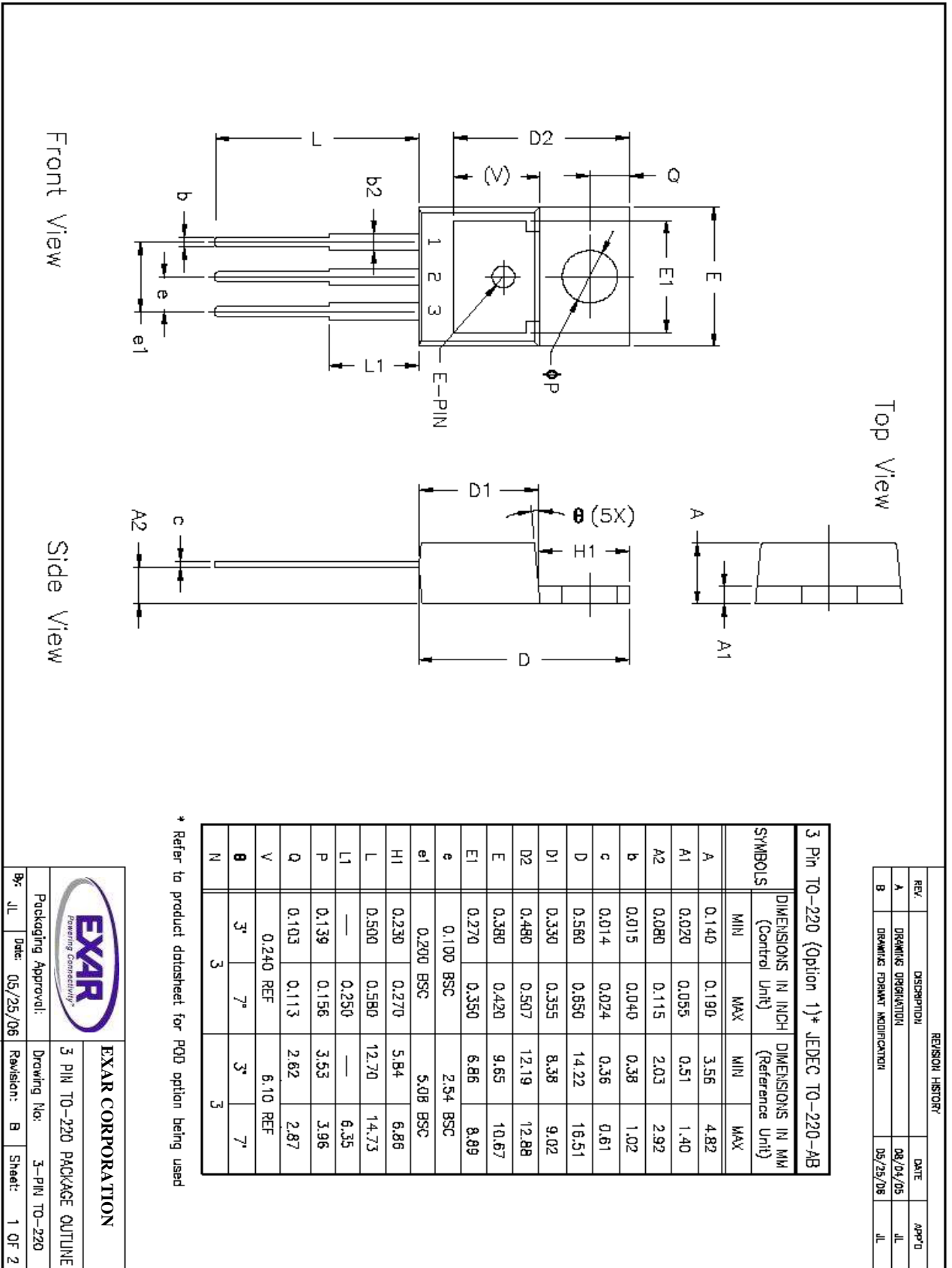

Figure 20. 5Vout PSRR. $V_{in}=10V$, $V_{out}=5V$, $C_{out}=22\mu F$, $I_{out}=10mA$.





REVISION HISTORY			
REV.	DESCRIPTION	DATE	APPRO
A	DRAWING ORIGINATOR	08/04/05	JL
B	DRAWING FORMAT MODIFICATION	05/25/06	JL

3 Pin TO-220 (Option 1)* JEDEC TO-220-AB				
SYMBOLS	DIMENSIONS IN INCH (Control Unit)		DIMENSIONS IN MM (Reference Unit)	
	MIN	MAX	MIN	MAX
A	0.140	0.190	3.56	4.82
A1	0.020	0.055	0.51	1.40
A2	0.080	0.115	2.03	2.92
b	0.015	0.040	0.38	1.02
c	0.014	0.024	0.36	0.61
D	0.560	0.650	14.22	16.51
D1	0.330	0.355	8.38	9.02
D2	0.480	0.507	12.19	12.88
E	0.380	0.420	9.65	10.67
E1	0.270	0.350	6.86	8.89
e	0.100 BSC		2.54 BSC	
e1	0.200 BSC		5.08 BSC	
H1	0.230	0.270	5.84	6.86
L	0.500	0.580	12.70	14.73
L1	—	0.250	—	6.35
P	0.139	0.156	3.53	3.96
Q	0.103	0.113	2.62	2.87
V	0.240 REF		6.10 REF	
θ	3°	7°	3°	7°
N	3		3	

* Refer to product datasheet for PDD option being used

		EXAR CORPORATION	
Packaging Approval:		3 Pin TO-220 PACKAGE OUTLINE	
Drawing No:	3-PIN TO-220	Revision:	B
Date:	05/25/06	Sheet:	1 OF 2

PACKAGE PINOUTS

TO-263-3 Package (T)

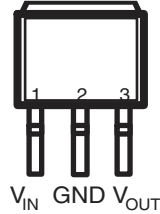

V_{IN} GND V_{OUT}

Front View
TAB = GND

TO-220-3 Package (U)

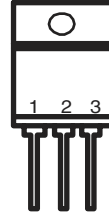

V_{IN} GND V_{OUT}

Front View
TAB = GND

ORDERING INFORMATION

PART NUMBER	ACC.	OUTPUT VOLTAGE	PACKAGE
SPX2940U-1-8	3%	1.8V	3 Lead TO-220
SPX2940U-2-5	3%	2.5V	3 Lead TO-220
SPX2940U-3-3	3%	3.3V	3 Lead TO-220
SPX2940U-5-0	3%	5.0V	3 Lead TO-220
SPX2940T-1-8	3%	1.8V	3 Lead TO-263
SPX2940T-1-8/TR	3%	1.8V	3 Lead TO-263
SPX2940T-2-5	3%	2.5V	3 Lead TO-263
SPX2940T-2-5/TR	3%	2.5V	3 Lead TO-263
SPX2940T-3-3	3%	3.3V	3 Lead TO-263
SPX2940T-3-3/TR	3%	3.3V	3 Lead TO-263
SPX2940T-5-0	3%	5.0V	3 Lead TO-263
SPX2940T-5-0/TR	3%	5.0V	3 Lead TO-263

Available in lead free packaging. To order add "-L" suffix to part number.

Example: SPX2940T-3-3/TR = standard; SPX2940T-L-3-3/TR = lead free

/TR = Tape and Reel

Pack quantity is 500 for TO-263.

EXAR Corporation reserves the right to make changes to the products contained in this publication in order to improve design, performance or reliability. EXAR Corporation assumes no responsibility for the use of any circuits described herein, conveys no license under any patent or other right, and makes no representation that the circuits are free of patent infringement. Charts and schedules contained here in are only for illustration purposes and may vary depending upon a user's specific application. While the information in this publication has been carefully checked; no responsibility, however, is assumed for inaccuracies.

EXAR Corporation does not recommend the use of any of its products in life support applications where the failure or malfunction of the product can reasonably be expected to cause failure of the life support system or to significantly affect its safety or effectiveness. Products are not authorized for use in such applications unless EXAR Corporation receives, in writing, assurances to its satisfaction that: (a) the risk of injury or damage has been minimized; (b) the user assumes all such risks; (c) potential liability of EXAR Corporation is adequately protected under the circumstances.

Copyright 2007 EXAR Corporation

Datasheet November 2007.