

# Chip Ferrite Bead High Current Type

SIM05-32 series

MERITEK

## FEATURE

- Operating temperature: -40°C ~ +125°C (Including self-temperature rise)
- Monolithic inorganic material construction.
- Closed magnetic circuit avoids crosstalk.
- Excellent solderability and heat resistance
- High reliability
- Low DC resistance electrode structure



## PART NUMBERING SYSTEM



SIM   05   601   Y   1A0   32  
(1)   (2)   (3)   (4)   (5)   (6)

No	item	Code	Description	
(1)	Product Code	SIM	Signal Chip Inductor, Multi-Layer Chip Ferrite Bead Type	
(2)	Dimension	05	05: 0805, 2.0x1.25mm	See Dimension Table
(3)	Impedence	601	601: 600Ω	First two: Significant, Third: Multiplier
(4)	Tolerance	Y	Y: ±25%	-25% ~ +25%
(5)	Rated Current	1A0	1A0: 1.0A	Max Current, 'A' denotes decimal point
(6)	Series Code	32	Chip Ferrite Bead, High Current Type	Internal Control Code

## DIMENSIONS

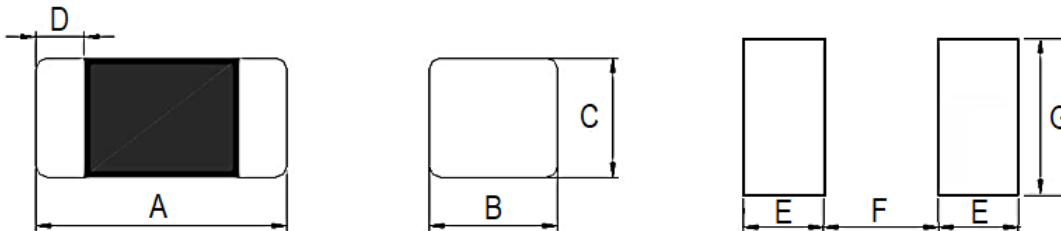

Size Code	A (mm)	B (mm)	C (mm)	D (mm)	E (mm)	F (mm)	G (mm)
SIM01 (0201)	0.60±0.03	0.30±0.03	0.30±0.03	0.15±0.05	0.35	0.30	0.40
SIM02 (0402)	1.00±0.10	0.50±0.10	0.50±0.10	0.25±0.10	0.50	0.40	0.60
SIM03 (0603)	1.60±0.15	0.80±0.15	0.80±0.15	0.30±0.20	0.80	0.85	0.95
SIM05 (0805)	2.00±0.20	1.25±0.20	0.85±0.20	0.50±0.30	1.05	1.00	1.45
SIM06 (1206)	3.20±0.20	1.60±0.20	1.10±0.20	0.50±0.30	1.05	2.20	1.80
SIM86 (1806)	4.50±0.20	1.60±0.20	1.60±0.20	0.50±0.30	1.05	3.30	1.80
SIM82 (1812)	4.50±0.20	3.20±0.20	1.50±0.20	0.50±0.30	1.05	3.30	3.40

# Chip Ferrite Bead High Current Type

SIM05-32 series

MERITEK

## ELECTRICAL CHARACTERISTICS

Size	Part Number	Impedance ( $\Omega$ )	Tolerance (%)	Test Frequency (MHz)	DCR ( $\Omega$ ) Max	Rated Current (mA)
0805	SIM05300Y3A032	30	$\pm 25$	100	0.04	3000
	SIM05800Y3A032	80	$\pm 25$	100	0.04	3000
	SIM05121Y2A032	120	$\pm 25$	100	0.10	2000
	SIM05151Y2A032	150	$\pm 25$	100	0.10	2000
	SIM05221Y2A032	220	$\pm 25$	100	0.10	2000
	SIM05301Y1A032	300	$\pm 25$	100	0.20	1000
	SIM05471Y1A032	470	$\pm 25$	100	0.20	1000
	SIM05601Y1A032	600	$\pm 25$	100	0.20	1000

## CHARICTERISTIC CURVES

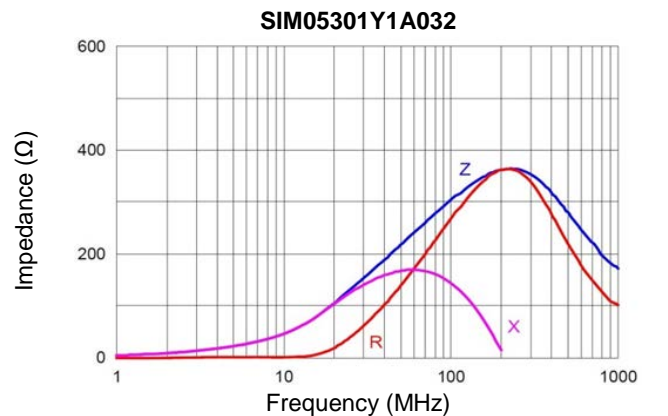
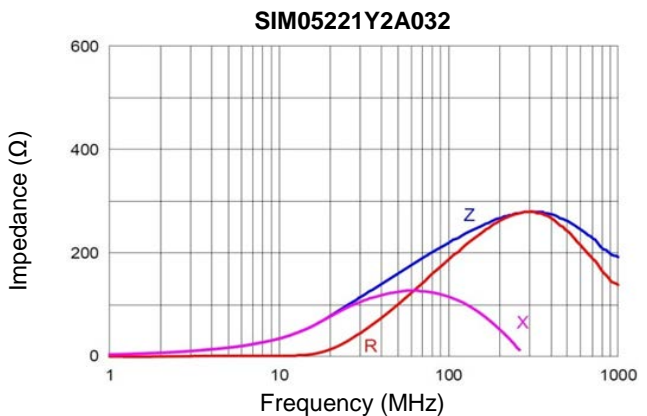
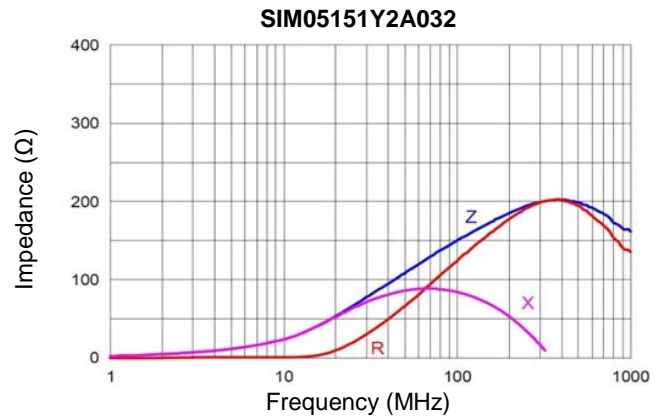
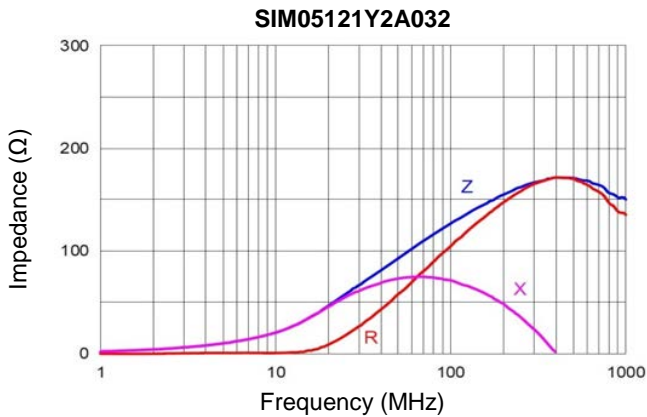
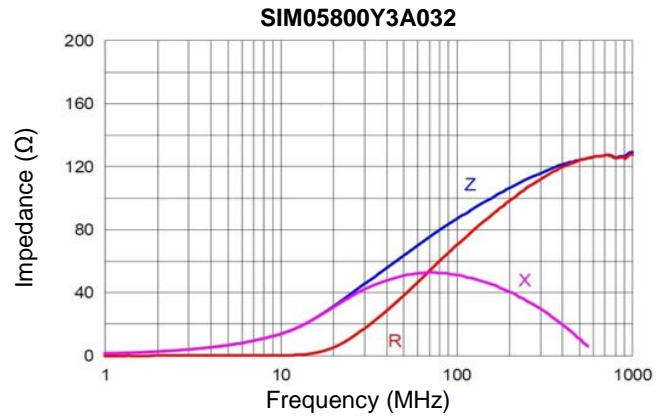
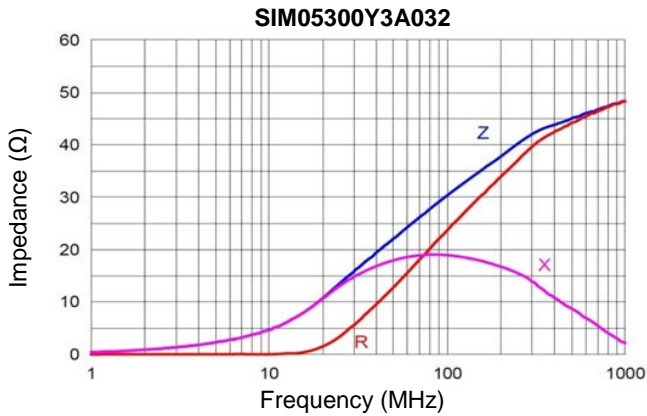

# Chip Ferrite Bead High Current Type

SIM05-32 series

MERITEK

## CHARACTERISTIC CURVES

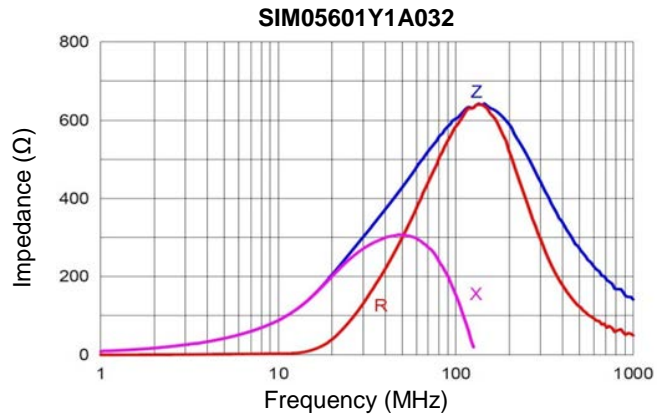
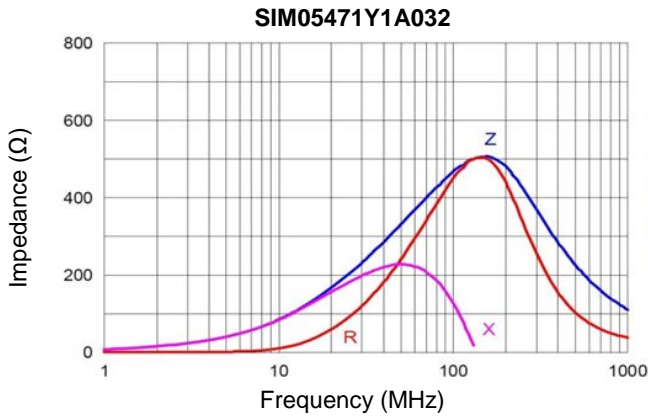

## RECOMMENDED SOLDERING PROFILES

Reflow Condition		
Pre Heat	Temp. Min $T_{s(min)}$	150°C
	Temp. Max $T_{s(max)}$	200°C
	Time (min. to max.) ( $t_s$ )	60 ~ 180 seconds
Reflow	Temp. ( $T_L$ )	217°C
	Time (min. to max.) ( $t_L$ )	60 ~ 150 seconds
Peak Temperature ( $T_P$ )		260°C
Time within 5°C of actual peak Temperature ( $t_p$ )		10 seconds max.
Reflow times:		3 times Max.

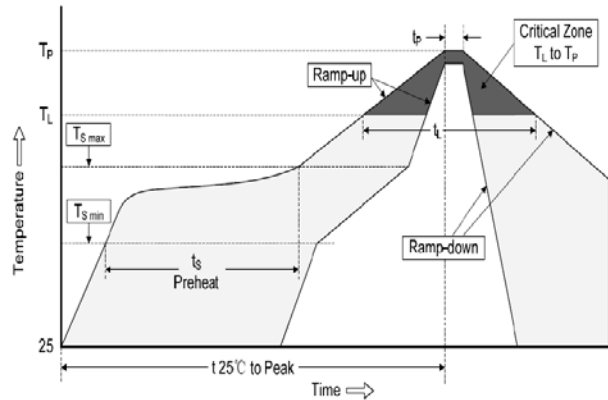

## DERATING CURVE

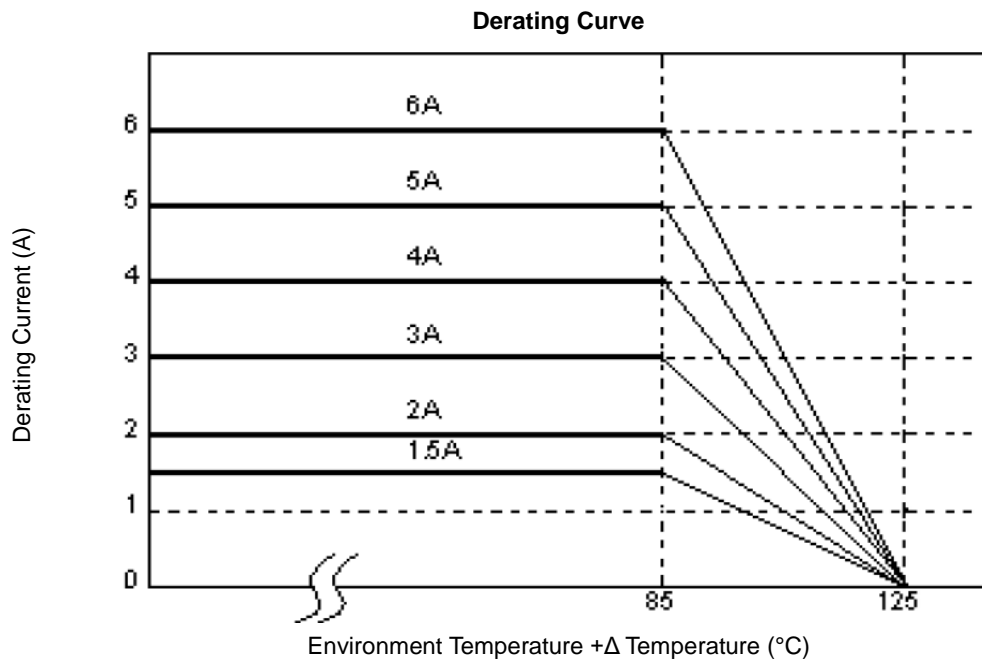

# Chip Ferrite Bead High Current Type

SIM05-32 series

**MERITEK**

## RELIABILITY TEST CONDITON AND REQUIREMENT

Item	Test Conditions	Requirement															
<b>Temperature Rise Test</b>	Applied the allowed DC current. Temperature measured by digital surface thermometer.	Rated Current < 1A ΔT 20°CMax. Rated Current ≥ 1A ΔT 40°CMax.															
<b>Solderability</b>	Preheat: 150°C for 60sec., Solder: Sn:96.5% - Ag:3% - Cu:0.5% Solder temperature: 245±5°C, Flux for lead free: Rosin. 9.5% Depth: completely cover the termination. Dip time: 4±1sec.	More than 95% of the terminal electrode should be covered with solder.															
<b>Resistance to Soldering Heat</b>	Solder temperature: 260±5°C for 10±1 seconds; Temperature ramp/immersion and emersion rate: 25mm/s ±6 mm/s. Depth: Completely cover the termination.	Appearance: no damage. Impedance: within±15%of initial value. Inductance: within±10%of initial value.															
<b>Vibration</b>	Preconditioning: Run through IR reflow for 2 times. Oscillation Frequency: 10~2K~10 Hz for 20 minutes Equipment: Vibration checker, Total Amplitude:1.52mm ± 10% Testing Time: 12 hours (20 minutes, 12 cycles each of 3 orientations)	Appearance: no damage. Impedance: within±15%of initial value. Inductance: within±10%of initial value.															
<b>Shock</b>	Test condition: <table border="1" data-bbox="318 877 1023 1014"> <thead> <tr> <th>Type</th> <th>Peak Value (g's)</th> <th>Normal duration (ms)</th> <th>Wave From</th> <th>Velocity change (ft/sec)</th> </tr> </thead> <tbody> <tr> <td>SMD</td> <td>50</td> <td>11</td> <td>Half-sine</td> <td>11.3</td> </tr> <tr> <td>Lead</td> <td>50</td> <td>11</td> <td>Half-sine</td> <td>11.3</td> </tr> </tbody> </table>	Type	Peak Value (g's)	Normal duration (ms)	Wave From	Velocity change (ft/sec)	SMD	50	11	Half-sine	11.3	Lead	50	11	Half-sine	11.3	Appearance: no damage. Impedance: within±10%of initial value. Inductance: within±10%of initial value.
Type	Peak Value (g's)	Normal duration (ms)	Wave From	Velocity change (ft/sec)													
SMD	50	11	Half-sine	11.3													
Lead	50	11	Half-sine	11.3													
<b>Terminal strength</b>	Preconditioning: Run through IR reflow for 2 times. With component mounted on a PCB apply a force >0805:1kg, <=0805:0.5kg to the side of a device being tested. This force shall be applied for 60 +1 seconds. Also, the force shall be applied gradually as not to shock the component being tested.	Appearance: no damage. Impedance: within±15%of initial value. Inductance: within±10%of initial value.															
<b>Thermal Shock</b>	Preconditioning: Run through IR reflow for 2 times. Number of cycles: 500. Condition for 1 cycle: <table border="1" data-bbox="318 1289 1019 1409"> <thead> <tr> <th>No.</th> <th>Temp. (°C)</th> <th>Time (min.)</th> </tr> </thead> <tbody> <tr> <td>1</td> <td>-40±2°C</td> <td>30±5</td> </tr> <tr> <td>2</td> <td>25±2°C</td> <td>≤30 seconds</td> </tr> <tr> <td>3</td> <td>+125±2°C</td> <td>30±5</td> </tr> </tbody> </table> Measured at room temperature after placing for 24±2 hrs.	No.	Temp. (°C)	Time (min.)	1	-40±2°C	30±5	2	25±2°C	≤30 seconds	3	+125±2°C	30±5	Appearance: no damage. Impedance: within±15%of initial value. Inductance: within±10%of initial value.			
No.	Temp. (°C)	Time (min.)															
1	-40±2°C	30±5															
2	25±2°C	≤30 seconds															
3	+125±2°C	30±5															
<b>Bending</b>	Shall be mounted on a FR4 substrate of the following dimensions: <table border="1" data-bbox="318 1507 1019 1598"> <thead> <tr> <th>Dimensions</th> <th>Bending depth</th> </tr> </thead> <tbody> <tr> <td>&gt;=0805:40x100x1.2mm</td> <td>1.2mm</td> </tr> <tr> <td>&lt;0805:40x100x0.8mm</td> <td>0.8mm</td> </tr> </tbody> </table> Duration of 10 sec for a min.	Dimensions	Bending depth	>=0805:40x100x1.2mm	1.2mm	<0805:40x100x0.8mm	0.8mm	Appearance: no damage. Impedance: within±10%of initial value. Inductance: within±10%of initial value.									
Dimensions	Bending depth																
>=0805:40x100x1.2mm	1.2mm																
<0805:40x100x0.8mm	0.8mm																
<b>Load Humidity</b>	Preconditioning: Run through IR reflow for 2 times. Humidity: 85±2%R.H. Temperature: 85±2°C. Duration: 1000hrs Min. with 100% rated current. Measured at room temperature after 24±2 hrs.	Appearance: no damage. Impedance: within±15%of initial value. Inductance: within±10%of initial value.															
<b>Life Test</b>	Preconditioning: Run through IR reflow for 2 times. Temperature: 125±2°C Applied current: rated current. Duration: 1000±12 Hrs. Measured at room temperature after 24±2 Hrs.	Appearance: no damage. Impedance: within±15%of initial value. Inductance: within±10%of initial value.															

# Chip Ferrite Bead High Current Type

SIM05-32 series

MERITEK

## PACKAGING SPECIFICATIONS

### Reel Specification & Packaging Quantity

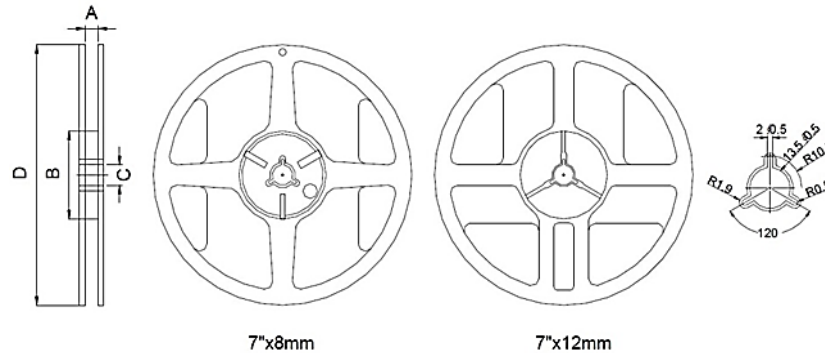

Size	Reel Dimension (mm)						
	Quantity	Tape Width	Reel Diameter	A	B	C	D
0201	Paper 15K	8mm	7"	9.5±0.5	60.0±2.0	13.5±0.5	178.0±2.0
0402	Paper 10K	8mm	7"	9.5±0.5	60.0±2.0	13.5±0.5	178.0±2.0
0603	Paper 4K	8mm	7"	9.5±0.5	60.0±2.0	13.5±0.5	178.0±2.0
0805	Paper 4K	8mm	7"	9.5±0.5	60.0±2.0	13.5±0.5	178.0±2.0
1206	Plastic 3K	8mm	7"	9.5±0.5	60.0±2.0	13.5±0.5	178.0±2.0
1806	Plastic 2K	12mm	7"	13.5±0.5	60.0±2.0	13.5±0.5	178.0±2.0
1812	Plastic 1K	12mm	7"	13.5±0.5	60.0±2.0	13.5±0.5	178.0±2.0

## PACKAGING SPECIFICATIONS

### Paper Tape Specification

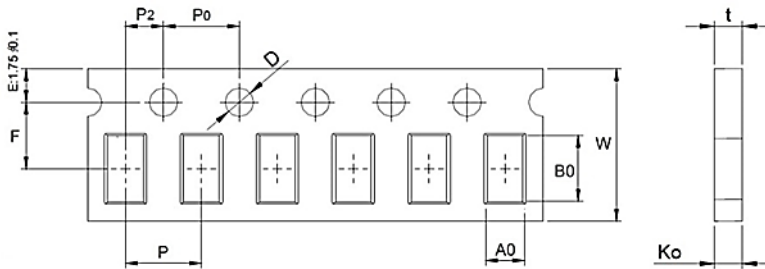

### Plastic Tape Specification

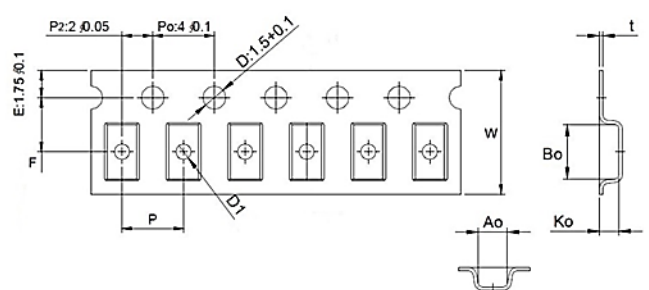

Size	Paper Tape Dimension (mm)									
	A0	B0	W	F	P <sub>0</sub>	P	P <sub>2</sub>	D	t	Ko
0201	0.4±0.06	0.7±0.06	8±0.3	3.5±0.05	4±0.1	2±0.05	-	1.5±0.1	0.45max	0.45max
0402	0.62±0.03	1.12±0.03	8±0.3	3.5±0.05	4±0.1	2±0.05	-	1.5±0.1	0.6±0.03	0.6±0.03
0603	0.96+0.05/-0.03	1.80±0.05	8±0.1	3.5±0.1	4±0.1	4±0.1	2±0.1	1.56+0.1/-0.05	0.95±0.05	0.95±0.05
0603*	0.97±0.03	1.78±0.03	8±0.1	3.5±0.1	4±0.1	4±0.1	2±0.1	1.56+0.1/-0.05	0.75±0.03	0.75±0.03
0805	1.3±0.05	2.1±0.05	8±0.1	3.5±0.1	4±0.1	4±0.1	2±0.1	1.56+0.1/-0.05	0.95±0.05	0.95±0.05
Size	Plastic Tape Dimension (mm)									
	A0	B0	W	F	P	P <sub>0</sub>	P <sub>2</sub>	D1	t	Ko
1206	1.75±0.1	3.35±0.1	8±0.1	3.5±0.05	4±0.1	4±0.1	2±0.05	1±0.1	0.23±0.05	1.25±0.1
1806	1.75±0.1	4.7±0.1	12±0.1	5.5±0.05	4±0.1	4±0.1	2±0.05	1.5±0.1	0.24±0.05	1.75±0.1
1812	3.45±0.1	4.7±0.1	12±0.1	5.5±0.05	8±0.1	4±0.1	2±0.05	1.5±0.1	0.24±0.05	1.60±0.1

Notes: \*0603 impedance value 26Ω, thickness is 0.60mm

\*Specifications subject to change without notice.