

## 100 mA Low Noise, High Ripple Rejection, Negative-voltage LDO Regulator

No. EA-379-220301

### OVERVIEW

The RP117x is a negative voltage LDO regulator that provides high ripple rejection and low output noise. Adding only one capacitor to each input and output pin can make a simple structure and high performance LDO regulator.

### KEY BENEFITS

- Provides high ripple rejection rate and low output noise, which is ideal for noise-sensitive devices.
- Requires only one capacitor for each input and output pin, and is available in small DFN(PL)1212-6 and SC-88A packages, both of which can utilize the space on board.

### KEY SPECIFICATIONS

- Input Voltage Range:  $-10.0\text{ V to }-2.5\text{ V}$
- Output Voltage Range:  $-5.5\text{ V to }-1.0\text{ V}$
- Output Current: 100 mA
- Supply Current: Typ. 75  $\mu\text{A}$
- Ripple Rejection Rate: Typ. 80 dB,  $f = 1\text{ kHz}$
- Output Noise: Typ. 16  $\mu\text{Vrms}$   
( $V_{\text{SET}} = -5.5\text{ V to }-2.0\text{ V}$ )
- Protection Features: Thermal Shutdown Protection  
Short-circuit Protection
- Auto-discharge Function

### TYPICAL APPLICATIONS

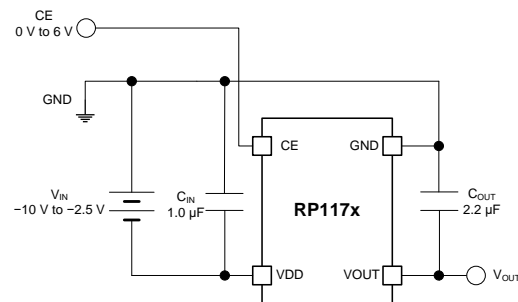

### PACKAGE

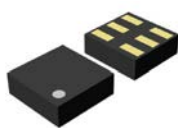

DFN(PL)1212-6  
1.20 x 1.20 x 0.4<sup>(1)</sup> (mm)  
<sup>(1)</sup> maximum dimension

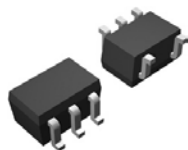

SC-88A  
2.0 x 2.1 x 0.9 (mm)

### SELECTION GUIDE

The set output voltage and the package type are user-selectable options.

Product Name	Package
RP117Kxx1D-TR	DFN(PL)1212-6
RP117Qxx2D-TR-FE	SC-88A

xx: Specify the set output voltage ( $V_{\text{SET}}$ ) within the range of  $-5.5\text{ V to }-1.0\text{ V}$  in 0.1 V steps.

### APPLICATIONS

- Noise-sensitive Devices: Sensors, DACs, ADCs, Amplifiers
- Audio Devices, DSLRs
- Measuring Instruments
- Liquid Crystal Panels, Bias Power Supply for CCDs

## SELECTION GUIDE

The RP117x includes an auto-discharge function<sup>(1)</sup>. A set output voltage and a package type are user-selectable options.

### Selection Guide

Product Name	Package	Quantity per Real	Pb Free	Halogen Free
RP117Kxx1D-TR	DFN(PL)1212-6	5,000 pcs	Yes	Yes
RP117Qxx2D-TR-FE	SC-88A	3,000 pcs	Yes	Yes

xx: Specify the set output voltage ( $V_{SET}$ ) within the range of  $-5.5\text{ V}$  to  $-1.0\text{ V}$  in  $0.1\text{ V}$  steps.

The voltage in  $0.05\text{ V}$  step is shown as follows:

Ex.  $-1.35\text{ V}$ : RP117x13xx5

## BLOCK DIAGRAM

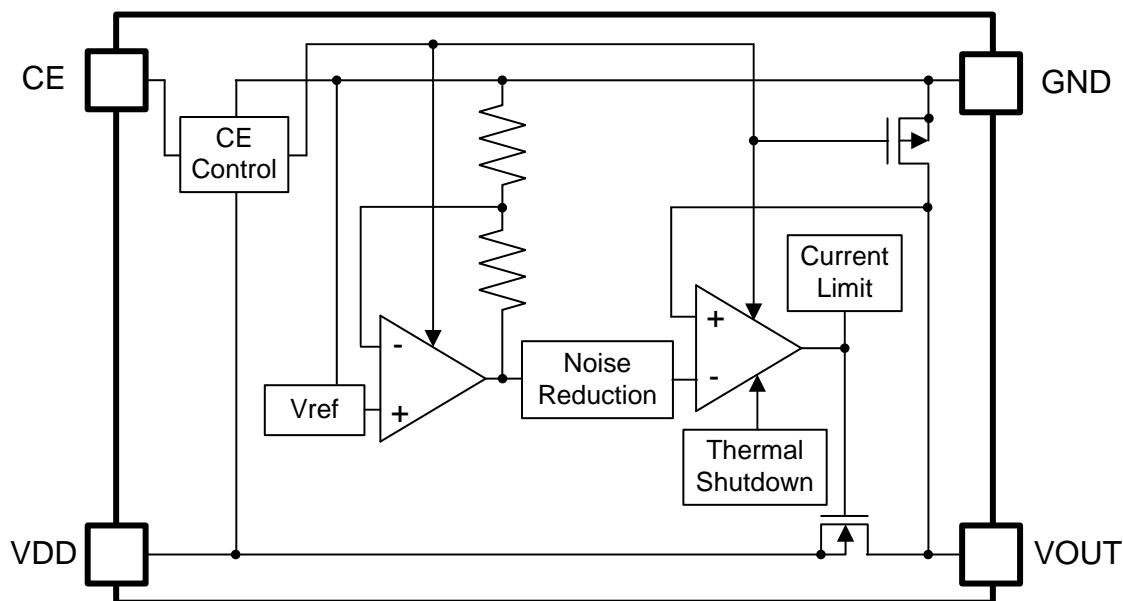

RP117x Block Diagram

<sup>(1)</sup> Auto-discharge function quickly lowers the output voltage to  $0\text{ V}$ , when the chip enable signal is switched from the active mode to the standby mode, by releasing the electrical charge accumulated in the external capacitor.

## PIN DESCRIPTIONS

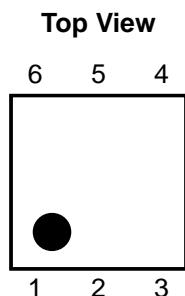

**DFN(PL)1212-6 Pin Configuration**

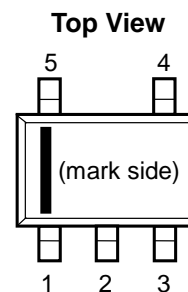
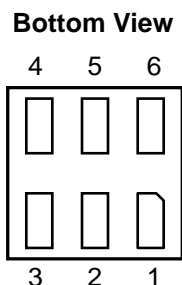

**SC-88A Pin Configuration**

### DFN(PL)1212-6 Pin Description

Pin No.	Symbol	Description
1	CE	Chip Enable Pin, Active-high
2	NC	No Connection
3	VDD	Input Pin
4	VOUT	Output Pin
5	NC	No Connection
6	GND	Ground Pin

### SC-88A Pin Description

Pin No.	Symbol	Description
1	GND	Ground Pin
2	VDD	Input Pin
3	VOUT	Output Pin
4	CE	Chip Enable Pin, Active-high
5	NC	No Connection

## ABSOLUTE MAXIMUM RATINGS

### Absolute Maximum Ratings

Symbol	Parameter		Rating	Unit
$V_{IN}$	Input Voltage		-11.0 to 0.3	V
$V_{CE}$	CE Pin Voltage		-0.3 to 7.0	V
$V_{OUT}$	VOUT Pin Voltage		$V_{IN} - 0.3$ to 0.3	V
$I_{OUT}$	Output Current		220	mA
$P_D$	Power Dissipation <sup>(1)</sup>	DFN(PL)1212-6 (JEDEC STD.51)	450	mW
		SC-88A (Standard Test Land Pattern)	380	mW
$T_j$	Junction Temperature		-40 to 125	°C
$T_{stg}$	Storage Temperature Range		-55 to 125	°C

#### ABSOLUTE MAXIMUM RATINGS

Electronic and mechanical stress momentarily exceeded absolute maximum ratings may cause the permanent damages and may degrade the life time and safety for both device and system using the device in the field. The functional operation at or over these absolute maximum ratings is not assured.

## RECOMMENDED OPERATING TEMPERATURE

### Recommended Operating Conditions

Symbol	Parameter	Rating	Unit
$V_{IN}$	Input Voltage	-10.0 to -2.5	V
$V_{CE}$	CE Pin Voltage	0 to 6.0	V
$T_a$	Operating Temperature	-40 to 85	°C

#### RECOMMENDED OPERATING CONDITIONS

All of electronic equipment should be designed that the mounted semiconductor devices operate within the recommended operating conditions. The semiconductor devices cannot operate normally over the recommended operating conditions, even if when they are used over such conditions by momentary electronic noise or surge. And the semiconductor devices may receive serious damage when they continue to operate over the recommended operating conditions.

<sup>(1)</sup> Please refer to *POWER DISSIPATION* for detailed information.

## ELECTRICAL CHARACTERISTICS

$V_{IN} = V_{SET} - 1.0\text{ V}$  ( $V_{SET} > -1.5\text{ V}$ ,  $V_{IN} = -2.5\text{ V}$ ),  $I_{OUT} = 1\text{ mA}$ ,  $C_{IN} = 1.0\text{ }\mu\text{F}$ ,  $C_{OUT} = 2.2\text{ }\mu\text{F}$ , unless otherwise noted. The specifications surrounded by   are guaranteed by design engineering at  $-40^{\circ}\text{C} \leq T_a \leq 85^{\circ}\text{C}$ .

### RP117x Electrical Characteristics

( $T_a = 25^{\circ}\text{C}$ )

Symbol	Parameter	Test Conditions/Comments	Min.	Typ.	Max.	Unit
$V_{OUT}$	Output Voltage	$T_a = 25^{\circ}\text{C}$	x 1.020		x 0.980	V
		$-40^{\circ}\text{C} \leq T_a \leq 85^{\circ}\text{C}$	<span style="border: 1px solid black; padding: 0 2px;">x 1.050</span>		<span style="border: 1px solid black; padding: 0 2px;">x 0.950</span>	V
$I_{OUT}$	Output Current		<span style="border: 1px solid black; padding: 0 2px;">100</span>			mA
$\frac{\Delta V_{OUT}}{\Delta I_{OUT}}$	Load Regulation	$1\text{ mA} \leq I_{OUT} \leq 100\text{ mA}$		10	<span style="border: 1px solid black; padding: 0 2px;">30</span>	mV
$V_{DIF}$	Dropout Voltage	$I_{OUT} = 100\text{ mA}$	Refer to <i>PRODUCT-SPECIFIC ELECTRICAL CHARACTERISTICS</i>			
$I_{SS}$	Supply Current	$I_{OUT} = 0\text{ mA}$		75	<span style="border: 1px solid black; padding: 0 2px;">150</span>	$\mu\text{A}$
$I_{STANDBY}$	Standby Current	$V_{CE} = 0\text{ V}$		0.01	0.15	$\mu\text{A}$
$\frac{\Delta V_{OUT}}{\Delta V_{IN}}$	Line Regulation	$-10.0\text{ V} \leq V_{IN} \leq V_{SET} - 0.5\text{ V}$ (Up to $-2.5\text{ V}$ )	<span style="border: 1px solid black; padding: 0 2px;">-0.30</span>		<span style="border: 1px solid black; padding: 0 2px;">0.30</span>	%/V
RR	Ripple Rejection	$f = 1\text{ kHz}$ , Ripple $0.2\text{ V}_{p-p}$ , $V_{IN} = V_{SET} - 1.0\text{ V}$ , $I_{OUT} = 30\text{ mA}$ ( $V_{SET} \geq -2.5\text{ V}$ , $V_{IN} = -3.5\text{ V}$ )		80		dB
$V_{IN}$	Input Voltage		<span style="border: 1px solid black; padding: 0 2px;">-10.0</span>		<span style="border: 1px solid black; padding: 0 2px;">-2.5</span>	V
$\frac{\Delta V_{OUT}}{\Delta T_a}$	Output Voltage Temperature Coefficient	$-40^{\circ}\text{C} \leq T_a \leq 85^{\circ}\text{C}$		$\pm 100$		ppm/ $^{\circ}\text{C}$
$I_{SC}$	Short Current Limit	$V_{OUT} = 0\text{ V}$		150		mA
$R_{CE}$	CE Pull-down Resistance	$V_{IN} = -5\text{ V}$ , $V_{CE} = 3\text{ V}$		5		M $\Omega$
$V_{CEH}$	CE Pin Input Voltage, high		<span style="border: 1px solid black; padding: 0 2px;">1.5</span>			V
$V_{CEL}$	CE Pin Input Voltage, low				<span style="border: 1px solid black; padding: 0 2px;">0.5</span>	V
en	Output Noise	BW = 10 Hz to 100 kHz, $I_{OUT} = 30\text{ mA}$	$V_{SET} > -2.0\text{ V}$	$44 - 13 \times  V_{SET} $		$\mu\text{V}_{rms}$
			$V_{SET} \leq -2.0\text{ V}$			
$T_{TSD}$	Thermal Shutdown Temperature Threshold, rising	Junction Temperature		165		$^{\circ}\text{C}$
$T_{TSR}$	Thermal Shutdown Temperature Threshold, falling	Junction Temperature		110		$^{\circ}\text{C}$
$R_{LOW}$	Auto-discharge PMOS On Resistance	$V_{IN} = -4.0\text{ V}$ , $V_{CE} = 0\text{ V}$		250		$\Omega$

All test items listed under *Electrical Characteristics* are done under the pulse load condition ( $T_J \approx T_a = 25^{\circ}\text{C}$ ) except Output Voltage Temperature Coefficient, Output Noise and Ripple Rejection.

## ELECTRICAL CHARACTERISTICS

The specifications surrounded by   are guaranteed by design engineering at  $-40^{\circ}\text{C} \leq T_a \leq 85^{\circ}\text{C}$ .

### RP117x Product-specific Electrical Characteristics

Product Name	V <sub>OUT</sub> [V]						V <sub>DIF</sub> [V]			
	T <sub>a</sub> = 25°C			-40°C ≤ T <sub>a</sub> ≤ 85°C			Typ.	Max.		
	Min.	Typ.	Max.	Min.	Typ.	Max.				
RP117x10xx	-1.020	-1.000	-0.980	-1.050	-1.000	-0.950	(1)	(1)		
RP117x11xx	-1.122	-1.100	-1.078	-1.155	-1.100	-1.045				
RP117x12xx	-1.224	-1.200	-1.176	-1.260	-1.200	-1.140				
RP117x13xx	-1.326	-1.300	-1.274	-1.365	-1.300	-1.235				
RP117x13xx5	-1.377	-1.350	-1.323	-1.417	-1.350	-1.283				
RP117x14xx	-1.428	-1.400	-1.372	-1.470	-1.400	-1.330				
RP117x15xx	-1.530	-1.500	-1.470	-1.575	-1.500	-1.425	0.66 <sup>(1)</sup>	<span style="border: 1px solid black; padding: 0 2px;">0.7</span>		
RP117x16xx	-1.632	-1.600	-1.568	-1.680	-1.600	-1.520				
RP117x17xx	-1.734	-1.700	-1.666	-1.785	-1.700	-1.615				
RP117x18xx	-1.836	-1.800	-1.764	-1.890	-1.800	-1.710				
RP117x19xx	-1.938	-1.900	-1.862	-1.995	-1.900	-1.805				
RP117x20xx	-2.040	-2.000	-1.960	-2.100	-2.000	-1.900				
RP117x21xx	-2.142	-2.100	-2.058	-2.205	-2.100	-1.995	0.31 <sup>(1)</sup>	<span style="border: 1px solid black; padding: 0 2px;">0.45</span>		
RP117x22xx	-2.244	-2.200	-2.156	-2.310	-2.200	-2.090				
RP117x23xx	-2.346	-2.300	-2.254	-2.415	-2.300	-2.185				
RP117x24xx	-2.448	-2.400	-2.352	-2.520	-2.400	-2.280				
RP117x25xx	-2.550	-2.500	-2.450	-2.625	-2.500	-2.375				
RP117x25xx5	-2.601	-2.550	-2.499	-2.677	-2.550	-2.423				
RP117x26xx	-2.652	-2.600	-2.548	-2.730	-2.600	-2.470				
RP117x27xx	-2.754	-2.700	-2.646	-2.835	-2.700	-2.565				
RP117x28xx	-2.856	-2.800	-2.744	-2.940	-2.800	-2.660				
RP117x29xx	-2.958	-2.900	-2.842	-3.045	-2.900	-2.755				
RP117x30xx	-3.060	-3.000	-2.940	-3.150	-3.000	-2.850			0.23	<span style="border: 1px solid black; padding: 0 2px;">0.30</span>
RP117x31xx	-3.162	-3.100	-3.038	-3.255	-3.100	-2.945				
RP117x32xx	-3.264	-3.200	-3.136	-3.360	-3.200	-3.040				
RP117x33xx	-3.366	-3.300	-3.234	-3.465	-3.300	-3.135				
RP117x34xx	-3.468	-3.400	-3.332	-3.570	-3.400	-3.230				
RP117x35xx	-3.570	-3.500	-3.430	-3.675	-3.500	-3.325				
RP117x36xx	-3.672	-3.600	-3.528	-3.780	-3.600	-3.420				
RP117x37xx	-3.774	-3.700	-3.626	-3.885	-3.700	-3.515				
RP117x38xx	-3.876	-3.800	-3.724	-3.990	-3.800	-3.610				
RP117x39xx	-3.978	-3.900	-3.822	-4.095	-3.900	-3.705				
RP117x40xx	-4.080	-4.000	-3.920	-4.200	-4.000	-3.800	0.13	<span style="border: 1px solid black; padding: 0 2px;">0.21</span>		
RP117x41xx	-4.182	-4.100	-4.018	-4.305	-4.100	-3.895				
RP117x42xx	-4.284	-4.200	-4.116	-4.410	-4.200	-3.990				
RP117x43xx	-4.386	-4.300	-4.214	-4.515	-4.300	-4.085				
RP117x44xx	-4.488	-4.400	-4.312	-4.620	-4.400	-4.180				
RP117x45xx	-4.590	-4.500	-4.410	-4.725	-4.500	-4.275				
RP117x46xx	-4.692	-4.600	-4.508	-4.830	-4.600	-4.370				
RP117x47xx	-4.794	-4.700	-4.606	-4.935	-4.700	-4.465				
RP117x48xx	-4.896	-4.800	-4.704	-5.040	-4.800	-4.560				
RP117x49xx	-4.998	-4.900	-4.802	-5.145	-4.900	-4.655				
RP117x50xx	-5.100	-5.000	-4.900	-5.250	-5.000	-4.750				
RP117x51xx	-5.202	-5.100	-4.998	-5.355	-5.100	-4.845				
RP117x52xx	-5.304	-5.200	-5.096	-5.460	-5.200	-4.940				
RP117x53xx	-5.406	-5.300	-5.194	-5.565	-5.300	-5.035				
RP117x54xx	-5.508	-5.400	-5.292	-5.670	-5.400	-5.130				
RP117x55xx	-5.610	-5.500	-5.390	-5.775	-5.500	-5.225				

<sup>(1)</sup> Input voltage should be equal or less than the maximum operating voltage (-2.5 V).

## THEORY OF OPERATION

### CE Pin Input Current

The CE pin input current is determined by the VDD pin input voltage and the CE pin input voltage as shown in the table below.

		CE Voltage[V]				
		1.5	2	3	4	5
V <sub>in</sub> [V]	-2.5	0.3	0.3	0.4	0.5	0.6
	-3	0.3	0.4	0.5	0.5	0.6
	-4	0.4	0.4	0.5	0.6	0.7
	-5	0.5	0.5	0.6	0.7	0.8
	-6	0.5	0.6	0.7	0.7	0.8
	-7	0.6	0.6	0.7	0.8	0.9
	-8	0.7	0.7	0.8	0.9	1.0
	-9	0.7	0.8	0.9	1.0	1.0
	-10	0.8	0.8	0.9	1.0	1.1

(μA)

**RP117x CE Pin Input Current**

### Minimum Operating Voltage

The RP 117x does not include an UVLO circuit. To make the internal circuit operate normally and to ensure good output regulation, V<sub>IN</sub> has to be:  $V_{IN} \leq V_{SET} - V_{DIF}$  (Max. -2.5 V). To bring out the best characteristics of the output noise voltage, the ripple rejection and the load transient response, V<sub>IN</sub> has to be  $V_{IN} = V_{SET} - 1.0$  V.

### Thermal Shutdown

Thermal shutdown deactivates a circuit when the junction temperature exceeds the thermal shutdown threshold (T<sub>TSD</sub>) of Typ. 165°C, and reactivates it when the junction temperature falls below the thermal shutdown release threshold (T<sub>TSR</sub>) of Typ. 110°C. During the reactivation, the inrush current limit is in operation. Note that deactivation and activation cycle can be repeated due to load, heat dissipation and ambient temperature conditions. Thermal shutdown cannot be used for the purpose of heat sink, so the repetitive cycles of deactivation and activation may affect the reliability of the device.

## APPLICATION INFORMATION

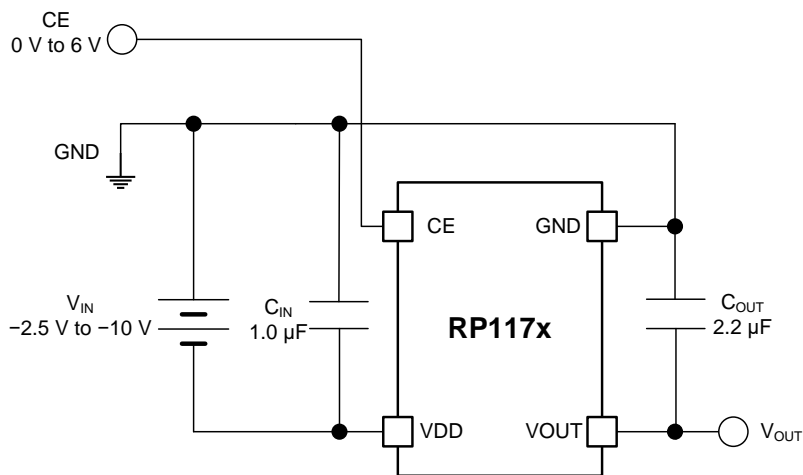

RP117x Typical Application Circuit

### External Components

Symbol	Description
C <sub>IN</sub>	Ceramic Capacitor, 1.0 μF, TDK, CGA3E1X7R1C105K
C <sub>OUT</sub>	Ceramic Capacitor, 2.2 μF, TDK, CGA5L2X7R1E225K

### Technical Notes on the Selection of External Components

- Phase compensation is provided to secure stable operation even when the load current is varied. For this purpose, use a 2.2-μF or more output capacitor (C<sub>OUT</sub>) with good frequency characteristics and proper ESR (Equivalent Series Resistance). In case of using a tantalum type capacitor with a large ESR, the output might become unstable. Evaluate your circuit including consideration of frequency characteristics.
- The high impedance of the wirings may result in noise pickup and unstable operation of the device. Reduce the impedance of the VDD and GND wirings. Connect a 1.0-μF or more input capacitor (C<sub>IN</sub>) between the VDD and GND pins with shortest-distance wiring. Also, connect a 2.2-μF or more output capacitor (C<sub>OUT</sub>) between the VOUT and GND pins with shortest-distance wiring



## TYPICAL CHARACTERISTICS

Note: Typical Characteristics are intended to be used as reference data; they are not guaranteed.

### 1) Output Voltage vs. Ambient Temperature ( $C_{IN}$ = Ceramic 1.0 $\mu$ F, $C_{OUT}$ = Ceramic 2.2 $\mu$ F)

RP117x101x

$V_{IN} = -2.5$  V,  $I_{OUT} = 1$  mA

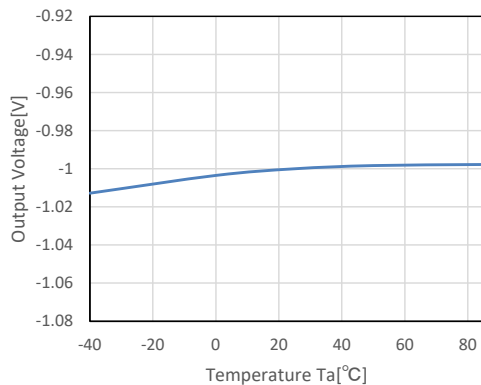

RP117x251x

$V_{IN} = -3.5$  V,  $I_{OUT} = 1$  mA

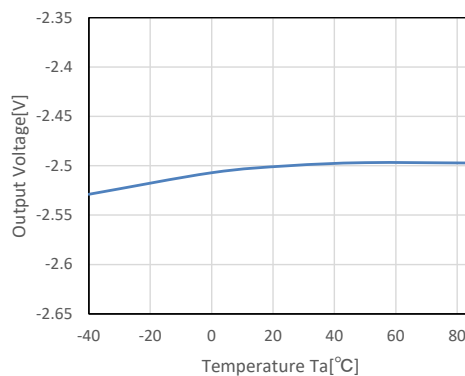

RP117x551x

$V_{IN} = -6.5$  V,  $I_{OUT} = 1$  mA

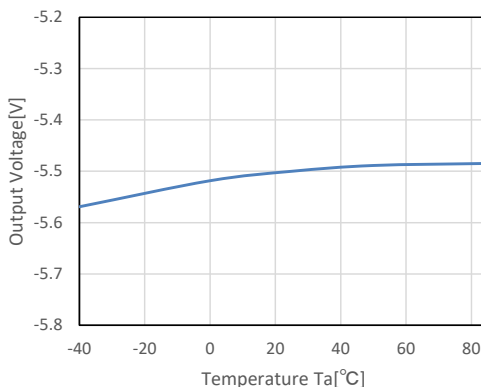

### 2) Supply Current vs. Ambient Temperature ( $C_{IN}$ = Ceramic 1.0 $\mu$ F, $C_{OUT}$ = Ceramic 2.2 $\mu$ F)

RP117x101x

$V_{IN} = -2.5$  V

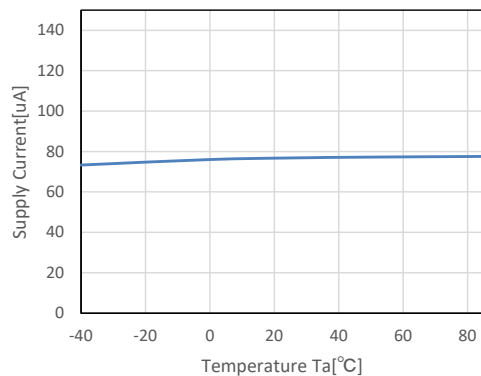

RP117x251x

$V_{IN} = -3.5$  V

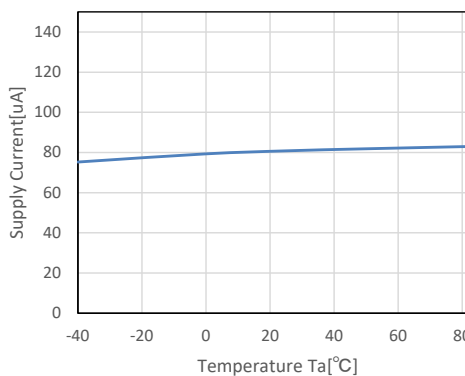

RP117x551x

$V_{IN} = -6.5\text{ V}$

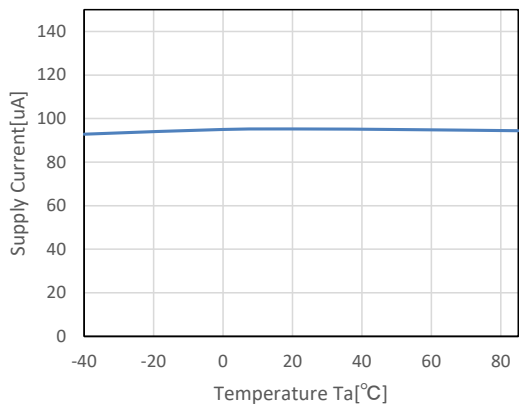

3) Dropout Voltage vs. Output Current ( $C_{IN} = \text{Ceramic } 1.0\ \mu\text{F}$ ,  $C_{OUT} = \text{Ceramic } 2.2\ \mu\text{F}$ )

RP117x101x

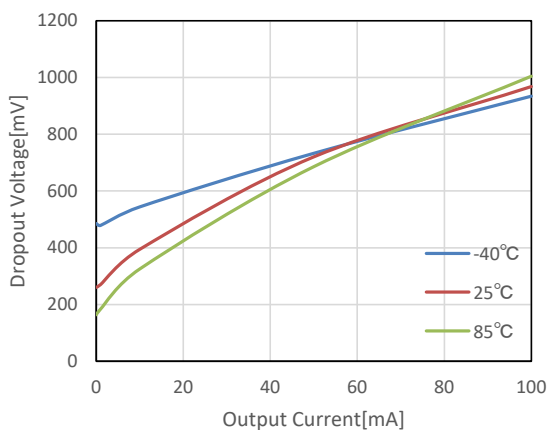

RP117x251x

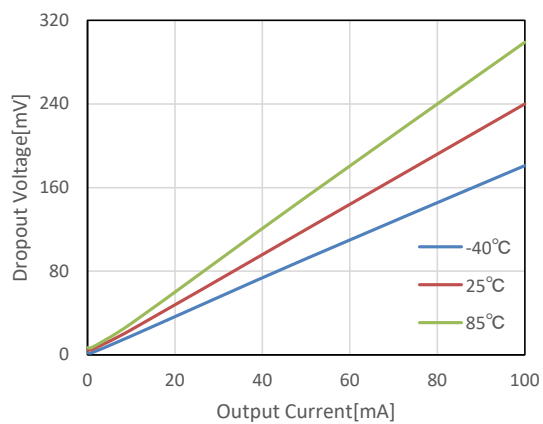

RP117x551x

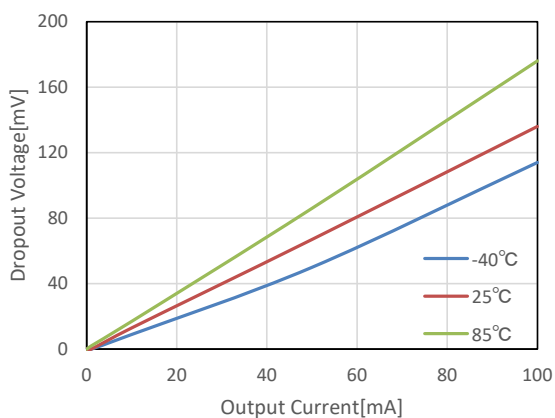

4) Dropout Voltage vs. Set Output Voltage ( $C_{IN}$  = Ceramic 1.0  $\mu$ F,  $C_{OUT}$  = Ceramic 2.2  $\mu$ F,  $T_a$  = 25°C)

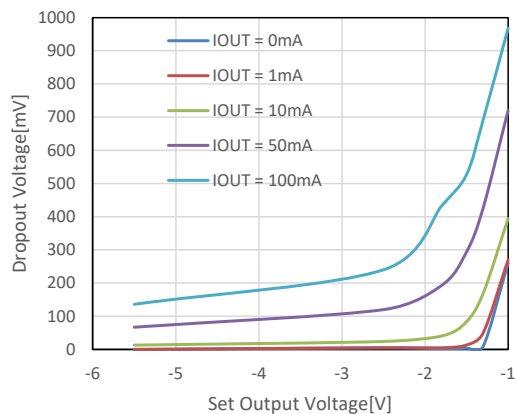

5) Output Voltage vs. Output Current ( $C_{IN}$  = Ceramic 1.0  $\mu$ F,  $C_{OUT}$  = Ceramic 2.2  $\mu$ F,  $T_a$  = 25°C)

RP117x101x

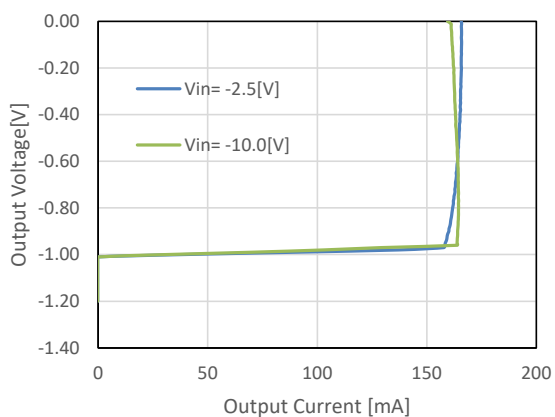

RP117x251x

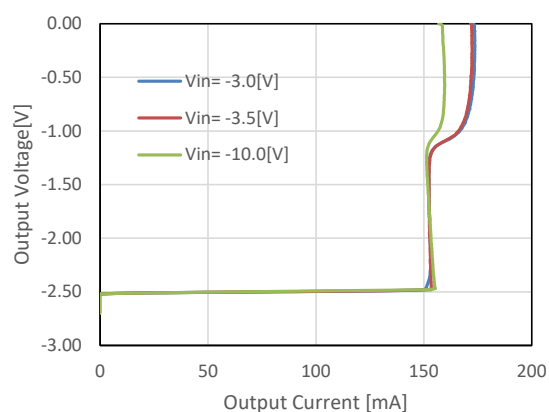

RP117x551x

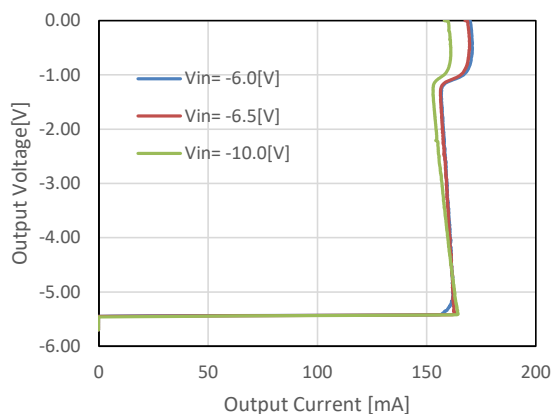

6) Output Voltage vs. Input Voltage ( $C_{IN}$  = Ceramic 1.0  $\mu$ F,  $C_{OUT}$  = Ceramic 2.2  $\mu$ F,  $T_a$  = 25°C)

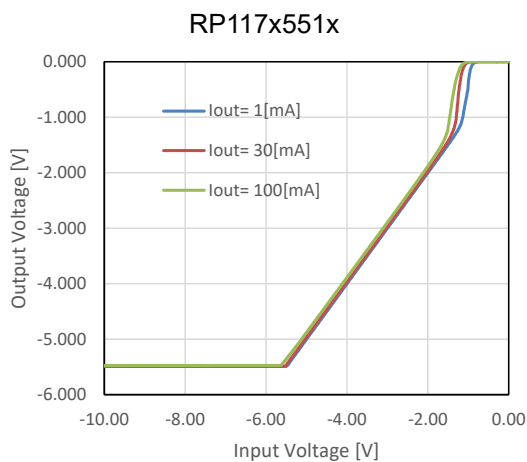
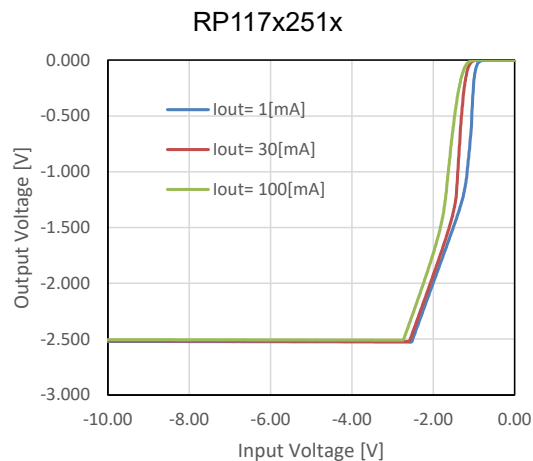
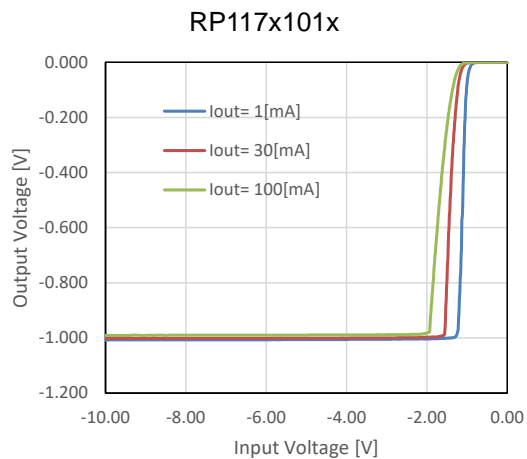

7) Supply Current vs. Input Voltage ( $C_{IN}$  = Ceramic 1.0  $\mu$ F,  $C_{OUT}$  = Ceramic 2.2  $\mu$ F,  $T_a$  = 25°C)

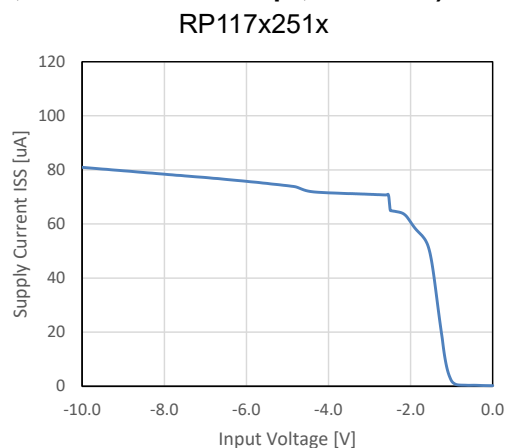
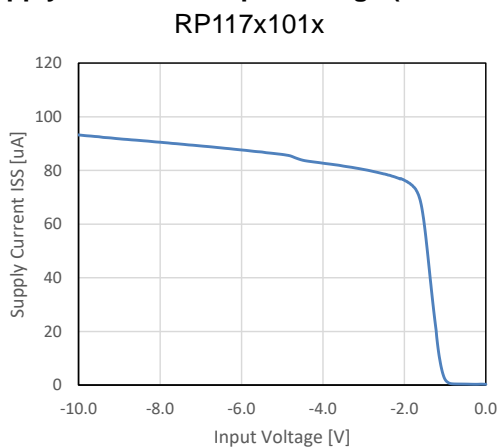

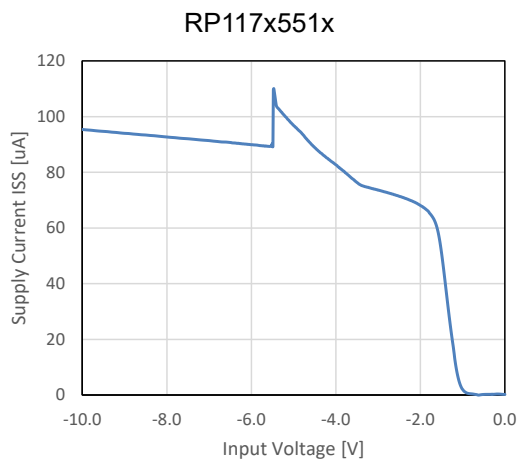

8) Ripple Rejection vs. Frequency ( $C_{IN}$  = none,  $C_{OUT}$  = Ceramic 2.2  $\mu$ F, Ripple = 0.2 Vp-p,  $T_a$  = 25°C)

RP117x101x

$V_{IN} = -3.5$  V

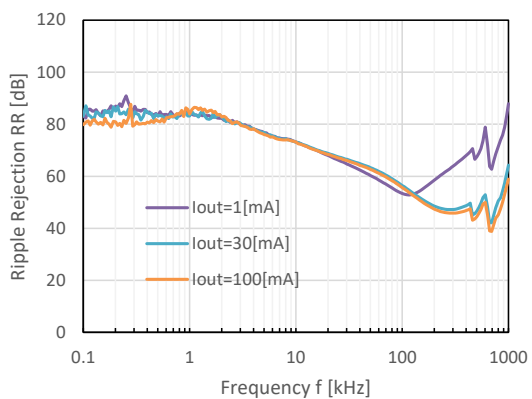

RP117x251x

$V_{IN} = -3.5$  V

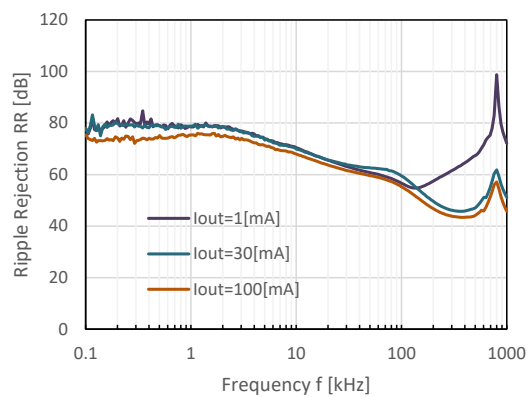

RP117x551x

$V_{IN} = -6.5$  V

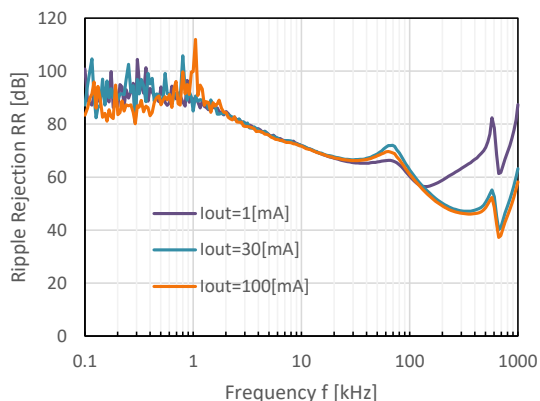

9) Ripple Rejection vs. Input Voltage ( $C_{IN}$  = none,  $C_{OUT}$  = Ceramic 2.2  $\mu$ F, Ripple = 0.2 Vp-p,  $T_a$  = 25°C)

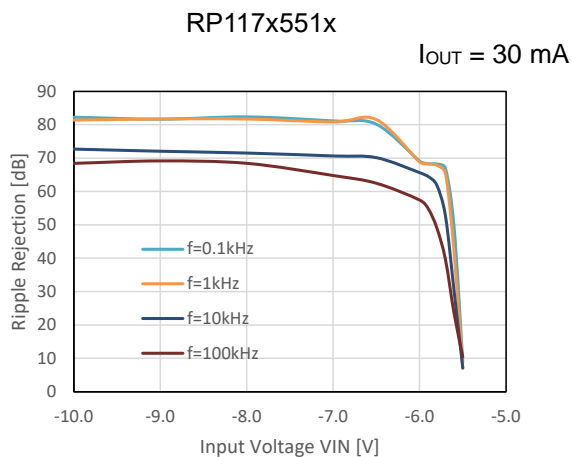
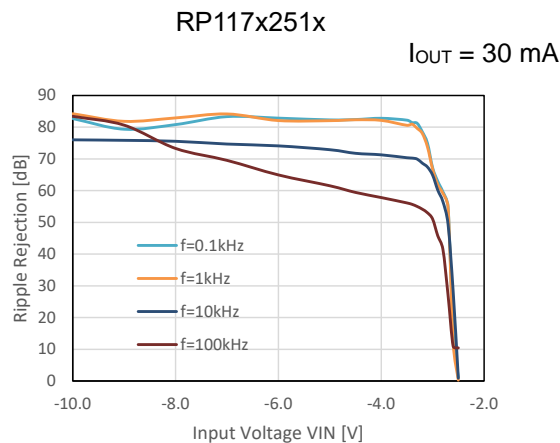
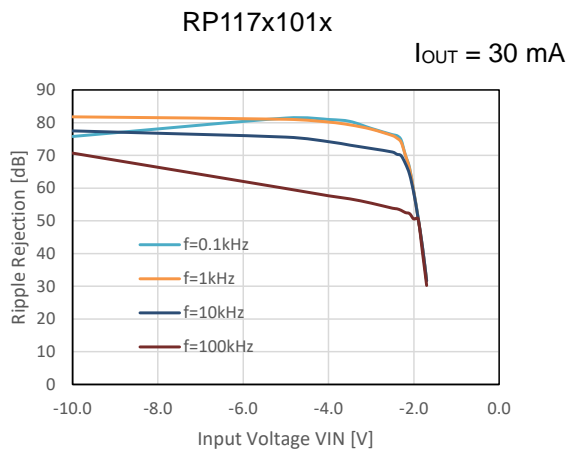

10) Output Noise vs. Ambient Temperature ( $C_{IN}$  = Ceramic 1.0  $\mu$ F,  $C_{OUT}$  = Ceramic 2.2  $\mu$ F)

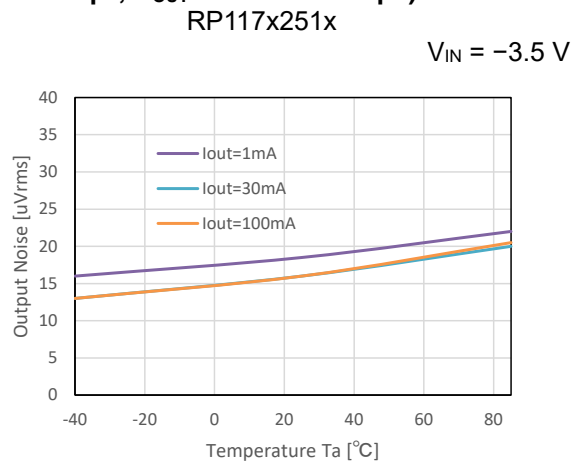
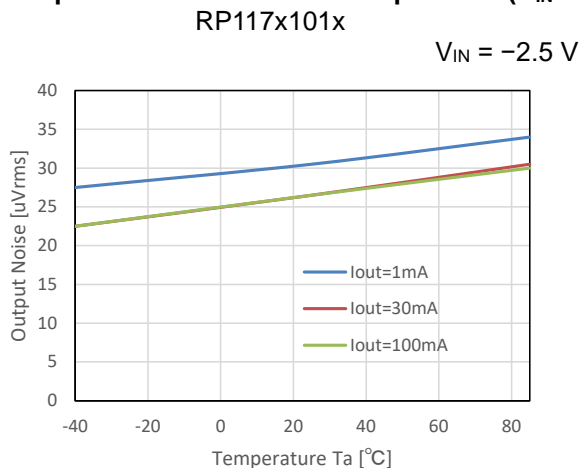

RP117x551x

$V_{IN} = -6.5\text{ V}$

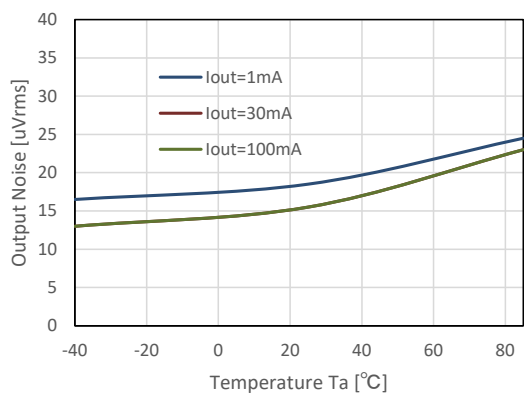

11) Output Noise vs. Frequency ( $C_{IN} = \text{Ceramic } 1.0\ \mu\text{F}$ ,  $C_{OUT} = \text{Ceramic } 2.2\ \mu\text{F}$ ,  $T_a = 25^\circ\text{C}$ )

RP117x101x

$V_{IN} = -2.5\text{ V}$

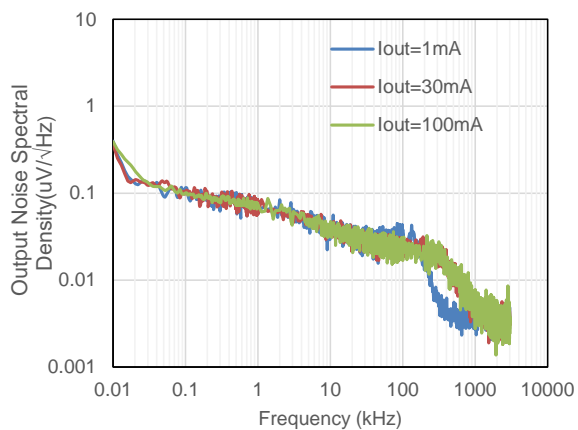

RP117x251x

$V_{IN} = -3.5\text{ V}$

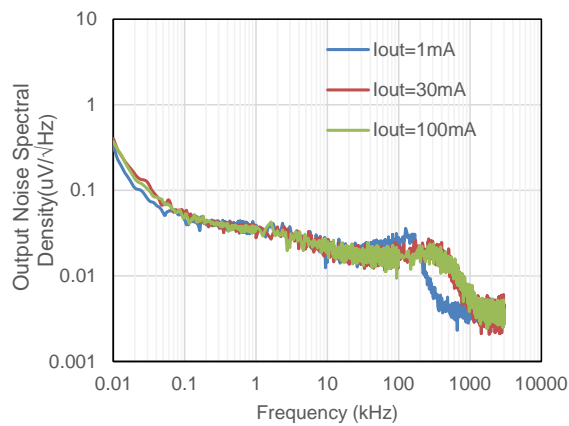

RP117x551x

$V_{IN} = -6.5\text{ V}$

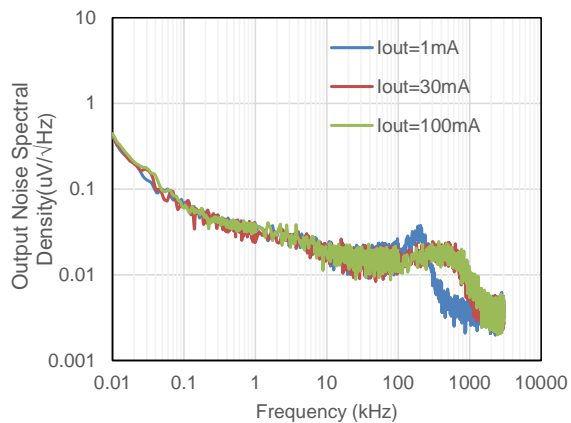

**12) Input Transient Response ( $C_{IN}$  = Ceramic 1.0  $\mu$ F,  $C_{OUT}$  = Ceramic 2.2  $\mu$ F,  $t_r = t_f = 10 \mu$ s,  $T_a = 25^\circ$ C)**

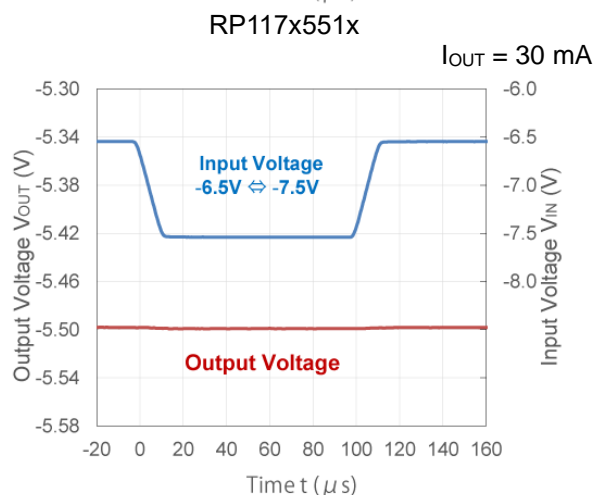
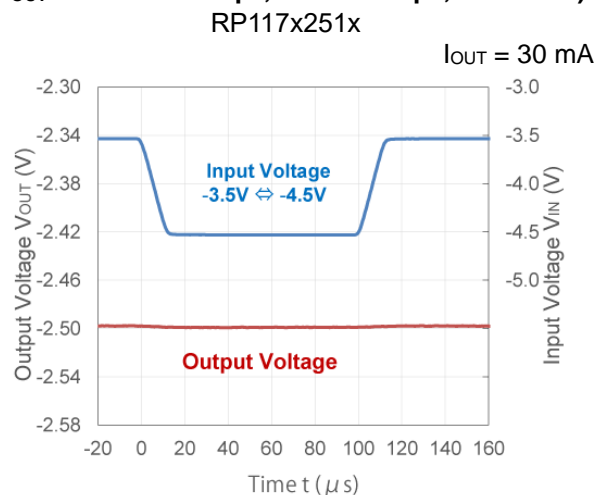
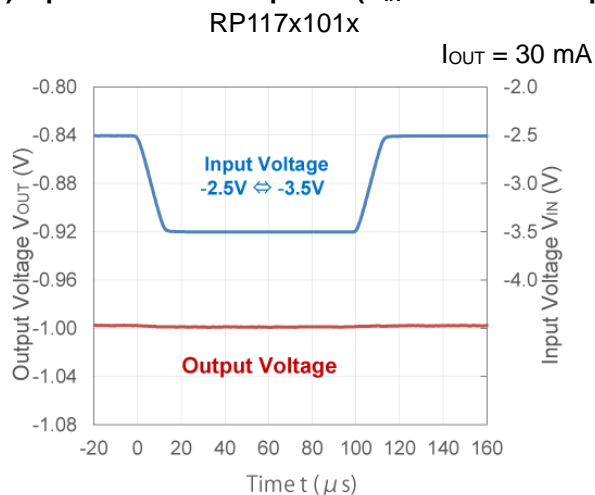

**13) Load Transient Response ( $C_{IN}$  = Ceramic 1.0  $\mu$ F,  $C_{OUT}$  = Ceramic 2.2  $\mu$ F,  $t_r = t_f = 0.5 \mu$ s,  $T_a = 25^\circ$ C)**

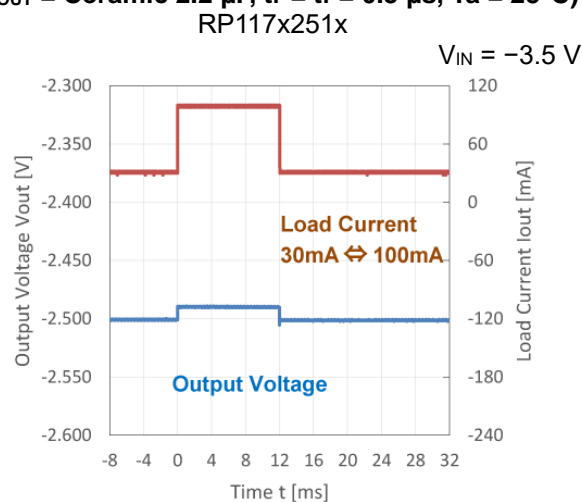
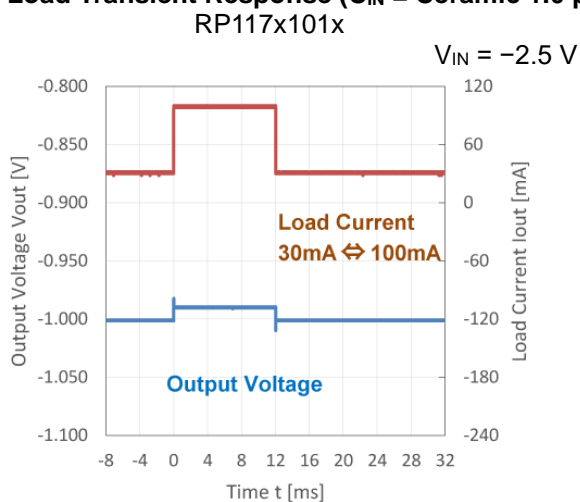



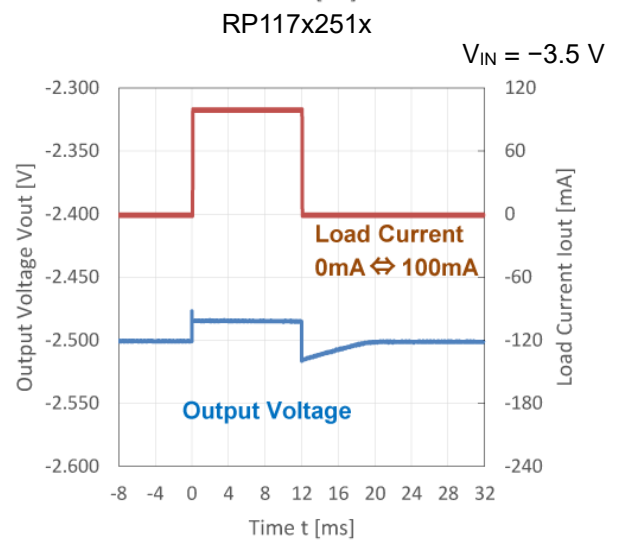
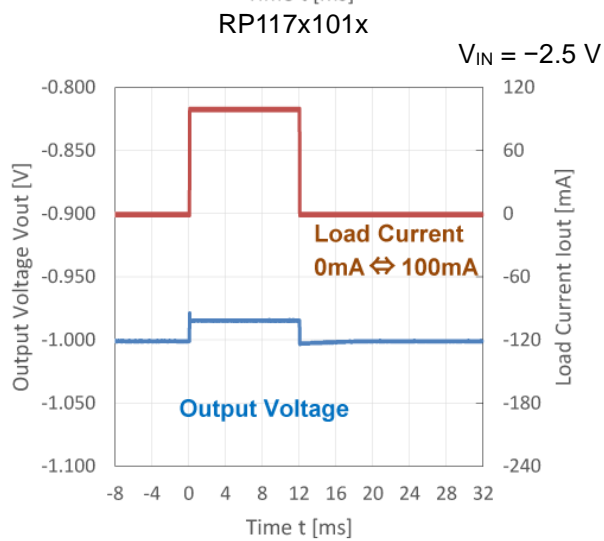
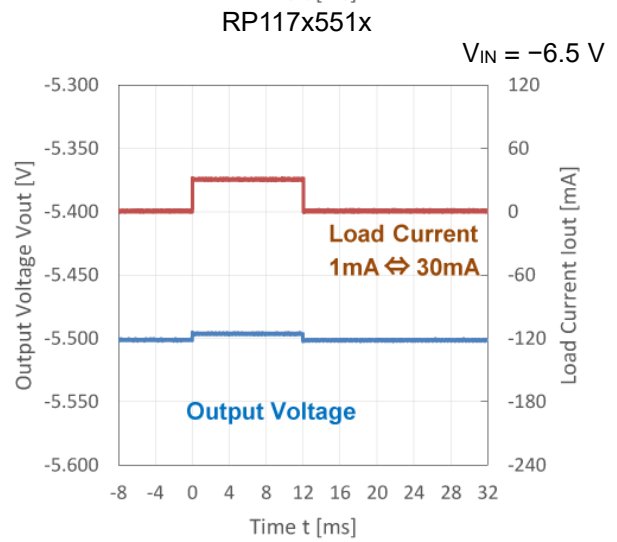
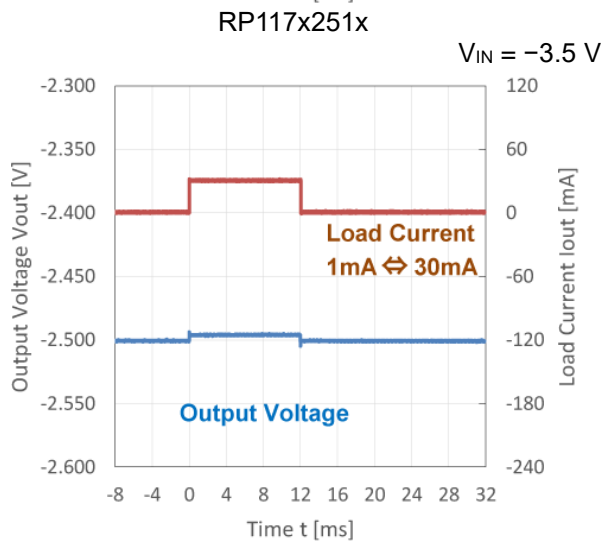
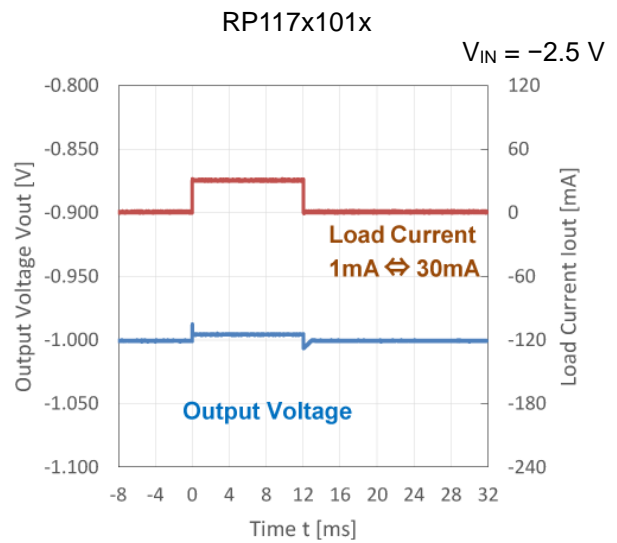
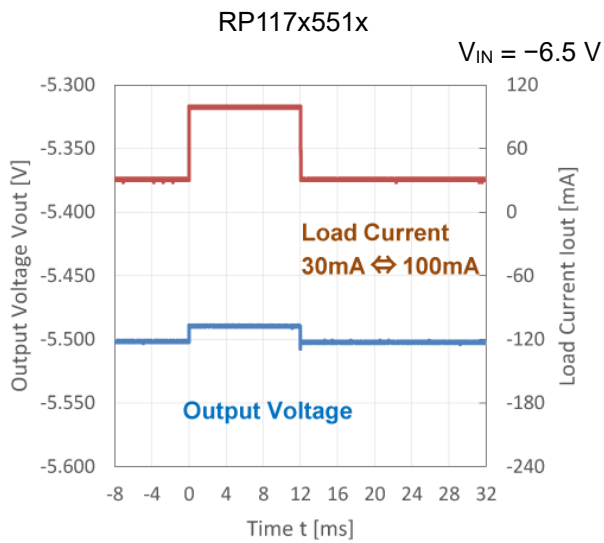

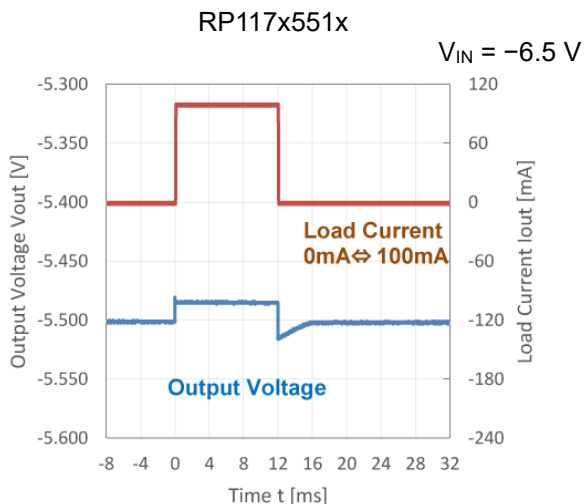

14) CE Pin Start-up Time ( $C_{IN} = \text{Ceramic } 1.0\ \mu\text{F}$ ,  $C_{OUT} = \text{Ceramic } 2.2\ \mu\text{F}$ ,  $t_r = t_f = 0.5\ \mu\text{s}$ ,  $T_a = 25^\circ\text{C}$ )

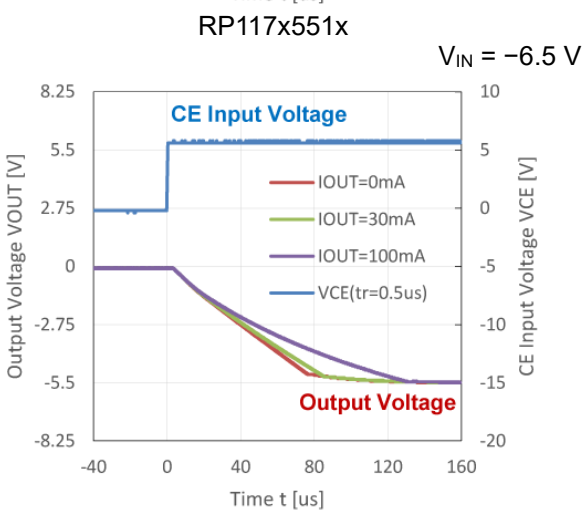
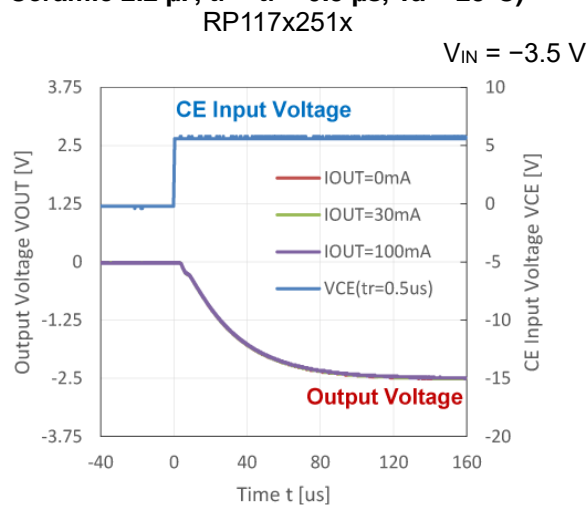
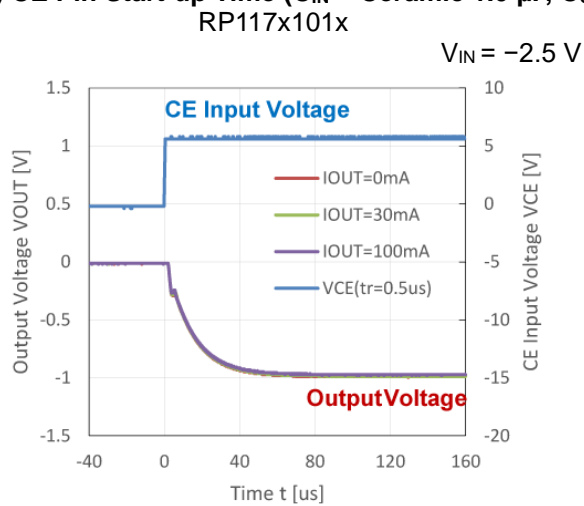

**15) CE Pin Shutdown Time ( $C_{IN} = \text{Ceramic } 1.0 \mu\text{F}$ ,  $C_{OUT} = \text{Ceramic } 2.2 \mu\text{F}$ ,  $t_r = t_f = 0.5 \mu\text{s}$ ,  $T_a = 25^\circ\text{C}$ )**

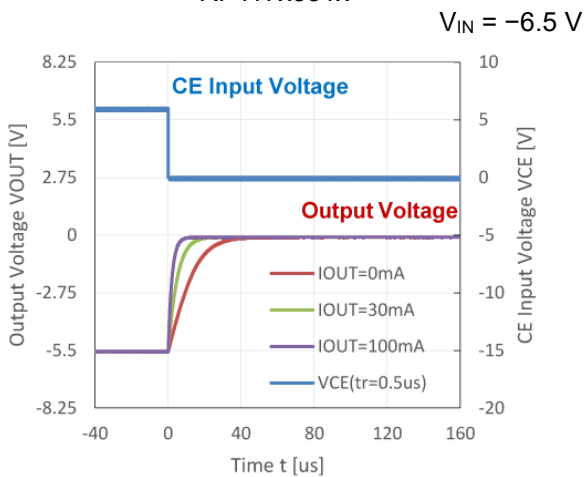
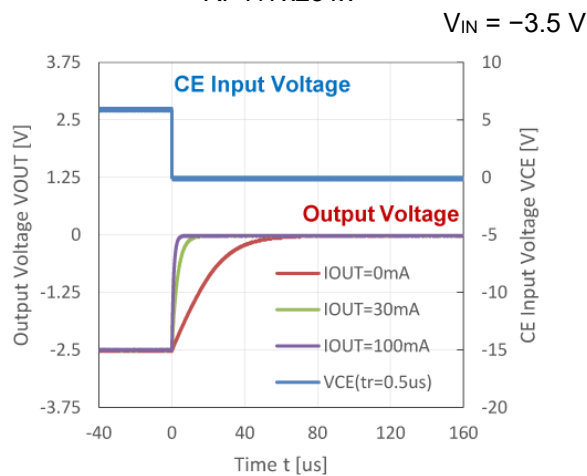
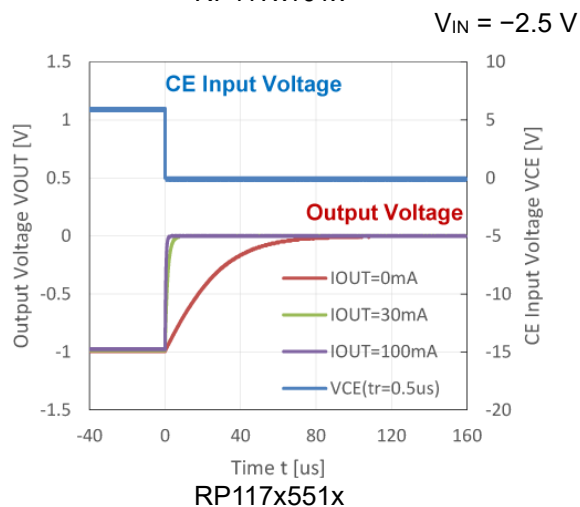

**16) Inrush Current ( $C_{IN} = \text{Ceramic } 1.0 \mu\text{F}$ ,  $C_{OUT} = \text{Ceramic } 2.2 \mu\text{F}$ ,  $t_r = t_f = 0.5 \mu\text{s}$ ,  $T_a = 25^\circ\text{C}$ )**

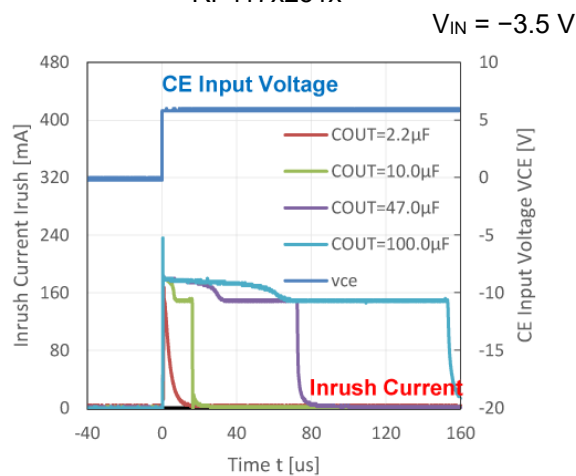
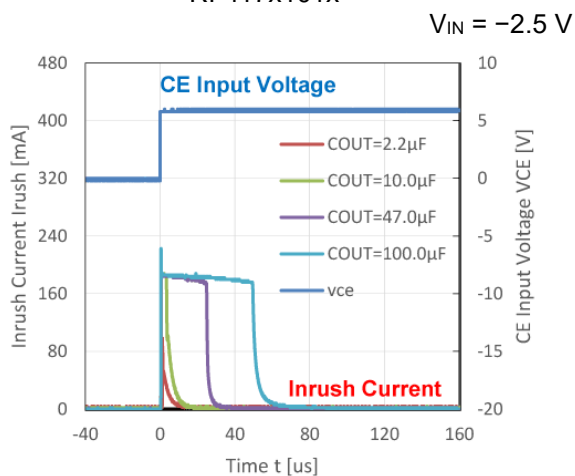

RP117x551x

$V_{IN} = -6.5\text{ V}$

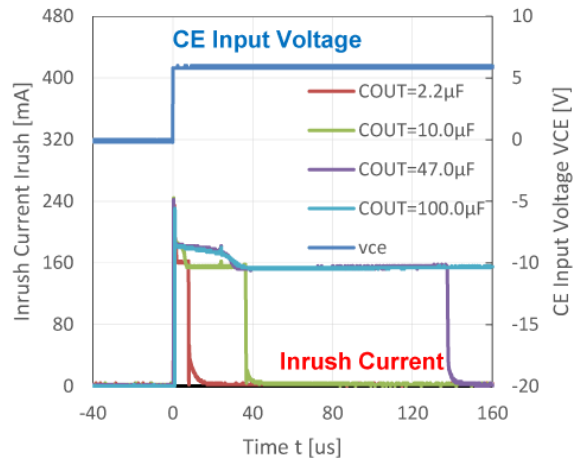

## Equivalent Series Resistance (ESR) vs. Output Current

It is recommended that a ceramic type capacitor be used for this device. However, other types of capacitors having lower ESR can also be used. The relation between the output current ( $I_{OUT}$ ) and the ESR of output capacitor is shown below.

### Measurement Conditions

Frequency Band: 10 Hz to 2 MHz

Ambient Temperature:  $-40^{\circ}\text{C}$  to  $85^{\circ}\text{C}$

Input Capacitor ( $C_{IN}$ ): Ceramic,  $1.0\ \mu\text{F}$

Output Capacitor ( $C_{OUT}$ ): Ceramic,  $2.2\ \mu\text{F}$

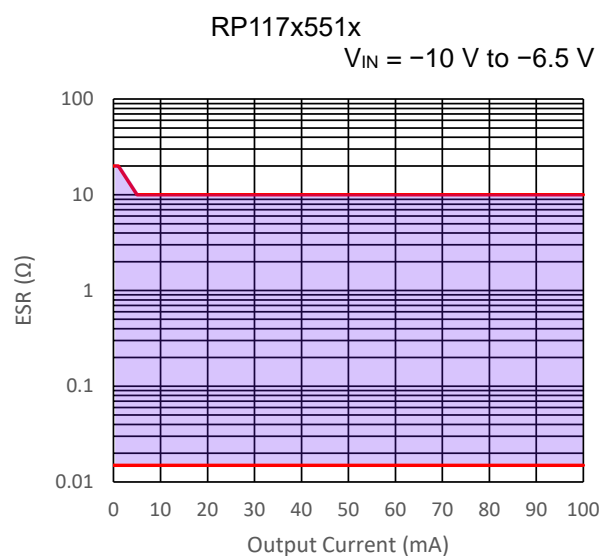
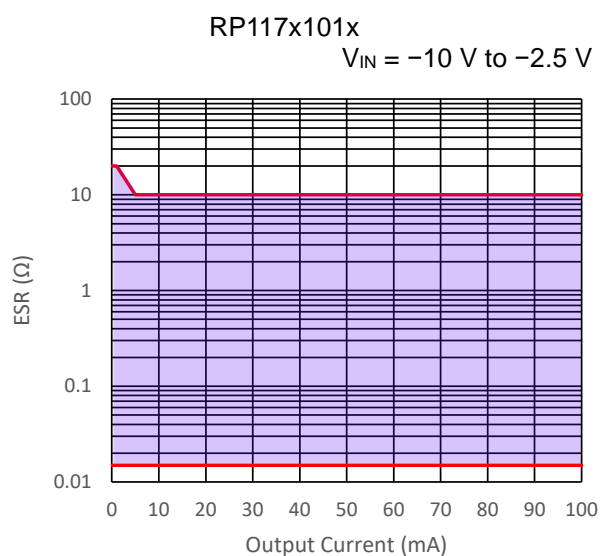

The power dissipation of the package is dependent on PCB material, layout, and environmental conditions. The following measurement conditions are based on JEDEC STD. 51-7.

**Measurement Conditions**

Item	Measurement Conditions
Environment	Mounting on Board (Wind Velocity = 0 m/s)
Board Material	Glass Cloth Epoxy Plastic (Four-Layer Board)
Board Dimensions	76.2 mm × 114.3 mm × 0.8 mm
Copper Ratio	Outer Layer (First Layer): Less than 95% of 50 mm Square Inner Layers (Second and Third Layers): Approx. 100% of 50 mm Square Outer Layer (Fourth Layer): Approx. 100% of 50 mm Square
Through-holes	φ 0.2 mm × 14 pcs

**Measurement Result**

(Ta = 25°C, Tjmax = 125°C)

Item	Measurement Result
Power Dissipation	450 mW
Thermal Resistance ( $\theta_{ja}$ )	$\theta_{ja} = 218^{\circ}\text{C/W}$
Thermal Characterization Parameter ( $\psi_{jt}$ )	$\psi_{jt} = 105^{\circ}\text{C/W}$

$\theta_{ja}$ : Junction-to-Ambient Thermal Resistance

$\psi_{jt}$ : Junction-to-Top Thermal Characterization Parameter

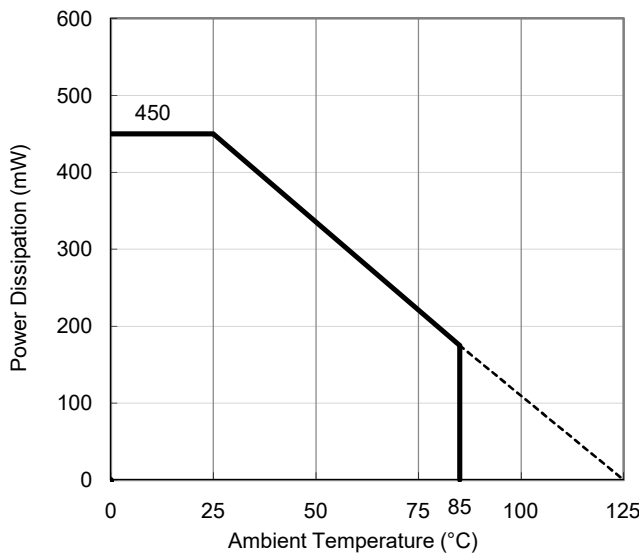

**Power Dissipation vs. Ambient Temperature**

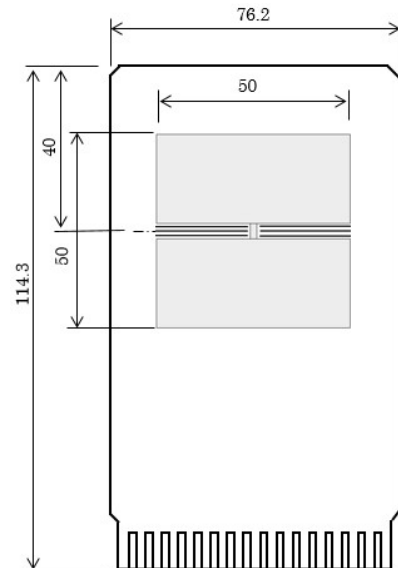

**Measurement Board Pattern**

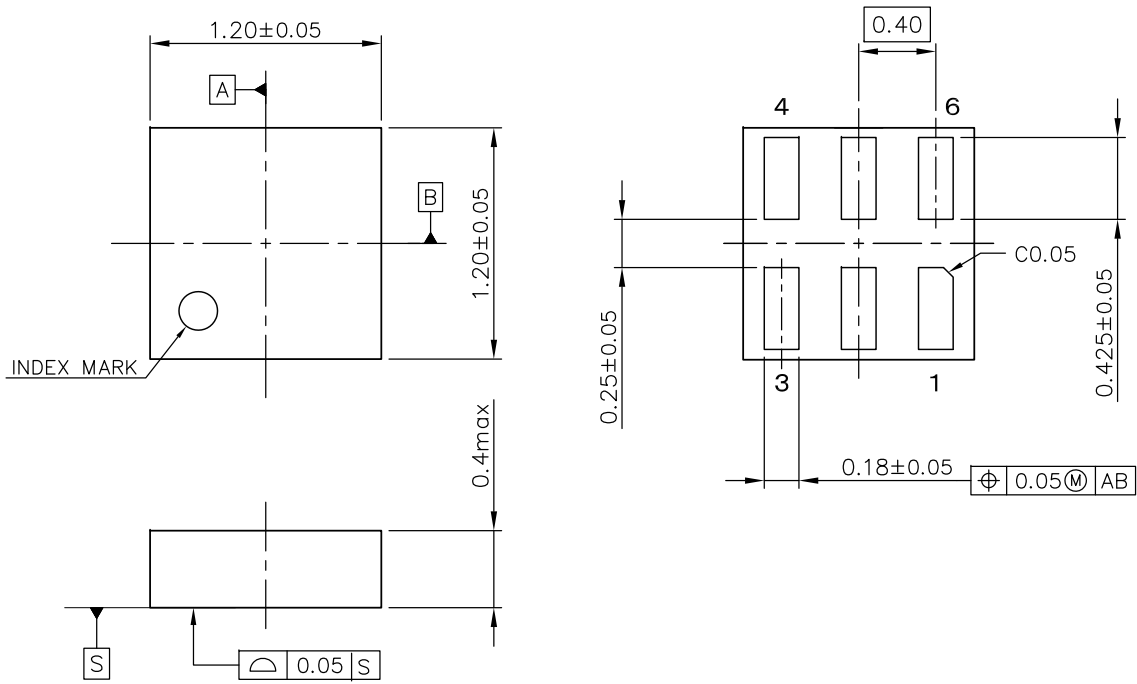

UNIT: mm

DFN(PL)1212-6 Package Dimensions

①②: Product Code ... Refer to *Part Marking List*

③④: Lot Number ... Alphanumeric Serial Number

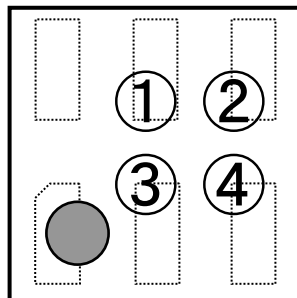

**DFN(PL)1212-6 Part Markings**

**NOTICE**

There can be variation in the marking when different AOI (Automated Optical Inspection) equipment is used. In the case of recognizing the marking characteristic with AOI, please contact our sales or our distributor before attempting to use AOI.



**RP117K Part Marking List**

<b>Product Name</b>	<b>①②</b>	<b>③④</b>
RP117K101D	XA	Lot No
RP117K111D	XB	Lot No
RP117K121D	XC	Lot No
RP117K131D	XD	Lot No
RP117K141D	XE	Lot No
RP117K151D	XF	Lot No
RP117K161D	XG	Lot No
RP117K171D	XH	Lot No
RP117K181D	XJ	Lot No
RP117K191D	XK	Lot No
RP117K201D	XL	Lot No
RP117K211D	XM	Lot No
RP117K221D	XN	Lot No
RP117K231D	XP	Lot No
RP117K241D	XR	Lot No
RP117K251D	XS	Lot No
RP117K261D	XT	Lot No
RP117K271D	XU	Lot No
RP117K281D	XV	Lot No
RP117K291D	XW	Lot No
RP117K301D	XX	Lot No
RP117K311D	XY	Lot No
RP117K321D	XZ	Lot No

<b>Product Name</b>	<b>①②</b>	<b>③④</b>
RP117K331D	YA	Lot No
RP117K341D	YB	Lot No
RP117K351D	YC	Lot No
RP117K361D	YD	Lot No
RP117K371D	YE	Lot No
RP117K381D	YF	Lot No
RP117K391D	YG	Lot No
RP117K401D	YH	Lot No
RP117K411D	YJ	Lot No
RP117K421D	YK	Lot No
RP117K431D	YL	Lot No
RP117K441D	YM	Lot No
RP117K451D	YN	Lot No
RP117K461D	YP	Lot No
RP117K471D	YR	Lot No
RP117K481D	YS	Lot No
RP117K491D	YT	Lot No
RP117K501D	YU	Lot No
RP117K511D	YV	Lot No
RP117K521D	YW	Lot No
RP117K531D	YX	Lot No
RP117K541D	YY	Lot No
RP117K551D	YZ	Lot No
RP117K131D5	X0	Lot No
RP117K251D5	X1	Lot No

The power dissipation of the package is dependent on PCB material, layout, and environmental conditions. The following conditions are used in this measurement.

**Measurement Conditions**

Item	Standard Test Land Pattern
Environment	Mounting on Board (Wind Velocity = 0 m/s)
Board Material	Glass Cloth Epoxy Plastic (Double-Sided Board)
Board Dimensions	40 mm × 40 mm × 1.6 mm
Copper Ratio	Top Side: Approx. 50% Bottom Side: Approx. 50%
Through-holes	φ 0.5 mm × 44 pcs

**Measurement Result**

(Ta = 25°C, Tjmax = 125°C)

Item	Standard Test Land Pattern
Power Dissipation	380 mW
Thermal Resistance ( $\theta_{ja}$ )	$\theta_{ja} = 263^{\circ}\text{C}/\text{W}$
Thermal Characterization Parameter ( $\psi_{jt}$ )	$\psi_{jt} = 75^{\circ}\text{C}/\text{W}$

$\theta_{ja}$ : Junction-to-Ambient Thermal Resistance

$\psi_{jt}$ : Junction-to-Top Thermal Characterization Parameter

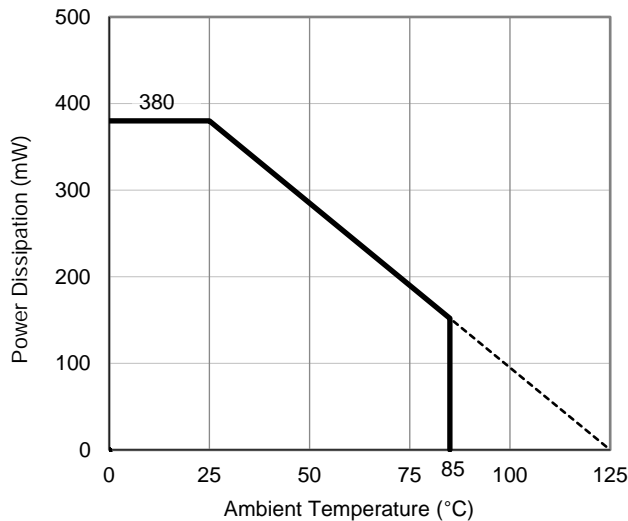

**Power Dissipation vs. Ambient Temperature**

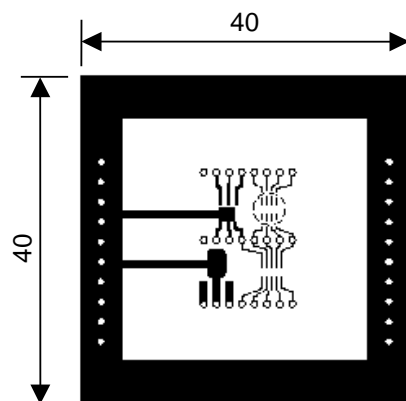

**Measurement Board Pattern**

**PACKAGE DIMENSIONS**

**SC-88A**

DM-SC-88A-JE-A

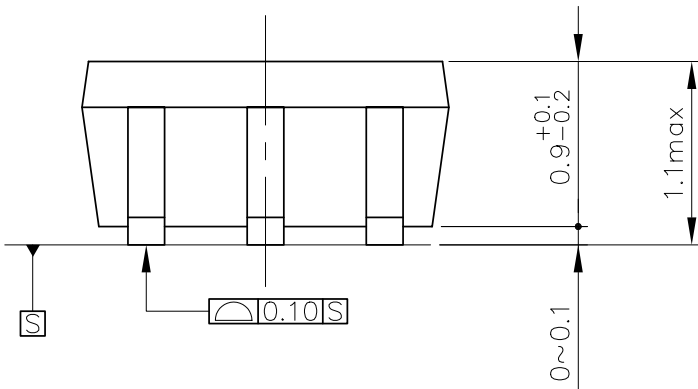
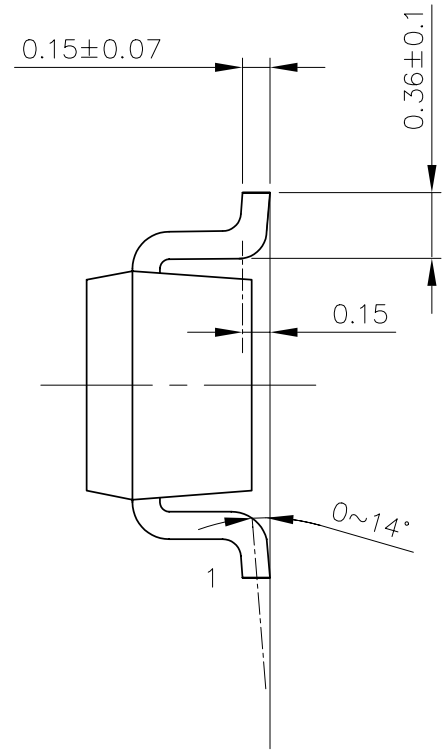
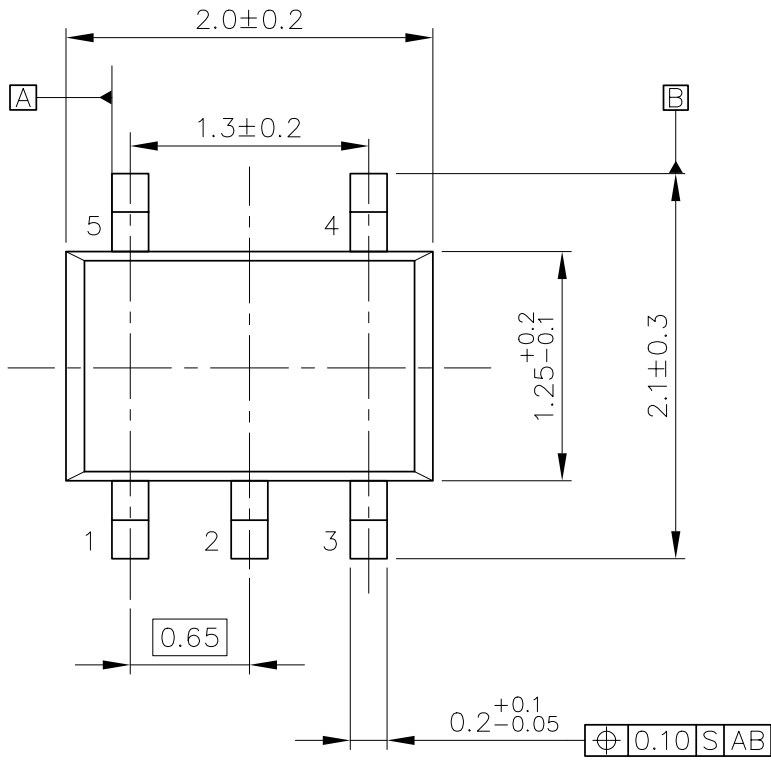

UNIT: mm

**SC-88A Package Dimensions**

①②③④: Product Code ... Refer to *Part Marking List*

⑤⑥: Lot Number ... Alphanumeric Serial Number

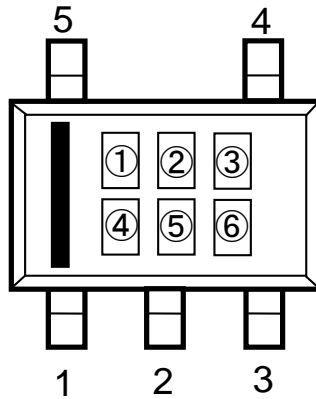

**SC-88 Part Markings**

**NOTICE**

There can be variation in the marking when different AOI (Automated Optical Inspection) equipment is used. In the case of recognizing the marking characteristic with AOI, please contact our sales or our distributor before attempting to use AOI.

# PART MARKINGS

# RP117Q

MK-RP117Q-JAEA-C

## R117Q Part Marking List

Product Name	①②③④	⑤⑥
RP117Q102D	A Y 1 0	Lot No
RP117Q112D	A Y 1 1	Lot No
RP117Q122D	A Y 1 2	Lot No
RP117Q132D	A Y 1 3	Lot No
RP117Q142D	A Y 1 4	Lot No
RP117Q152D	A Y 1 5	Lot No
RP117Q162D	A Y 1 6	Lot No
RP117Q172D	A Y 1 7	Lot No
RP117Q182D	A Y 1 8	Lot No
RP117Q192D	A Y 1 9	Lot No
RP117Q202D	A Y 2 0	Lot No
RP117Q212D	A Y 2 1	Lot No
RP117Q222D	A Y 2 2	Lot No
RP117Q232D	A Y 2 3	Lot No
RP117Q242D	A Y 2 4	Lot No
RP117Q252D	A Y 2 5	Lot No
RP117Q262D	A Y 2 6	Lot No
RP117Q272D	A Y 2 7	Lot No
RP117Q282D	A Y 2 8	Lot No
RP117Q292D	A Y 2 9	Lot No
RP117Q302D	A Y 3 0	Lot No
RP117Q312D	A Y 3 1	Lot No
RP117Q322D	A Y 3 2	Lot No
RP117Q332D	A Y 3 3	Lot No
RP117Q342D	A Y 3 4	Lot No
RP117Q352D	A Y 3 5	Lot No
RP117Q362D	A Y 3 6	Lot No
RP117Q372D	A Y 3 7	Lot No
RP117Q382D	A Y 3 8	Lot No
RP117Q392D	A Y 3 9	Lot No
RP117Q402D	A Y 4 0	Lot No

Product Name	①②③④	⑤⑥
RP117Q412D	A Y 4 1	Lot No
RP117Q422D	A Y 4 2	Lot No
RP117Q432D	A Y 4 3	Lot No
RP117Q442D	A Y 4 4	Lot No
RP117Q452D	A Y 4 5	Lot No
RP117Q462D	A Y 4 6	Lot No
RP117Q472D	A Y 4 7	Lot No
RP117Q482D	A Y 4 8	Lot No
RP117Q492D	A Y 4 9	Lot No
RP117Q502D	A Y 5 0	Lot No
RP117Q512D	A Y 5 1	Lot No
RP117Q522D	A Y 5 2	Lot No
RP117Q532D	A Y 5 3	Lot No
RP117Q542D	A Y 5 4	Lot No
RP117Q552D	A Y 5 5	Lot No
RP117Q132D5	A Y 5 6	Lot No
RP117Q252D5	A Y 5 7	Lot No

1. The products and the product specifications described in this document are subject to change or discontinuation of production without notice for reasons such as improvement. Therefore, before deciding to use the products, please refer to our sales representatives for the latest information thereon.
2. The materials in this document may not be copied or otherwise reproduced in whole or in part without the prior written consent of us.
3. This product and any technical information relating thereto are subject to complementary export controls (so-called KNOW controls) under the Foreign Exchange and Foreign Trade Law, and related politics ministerial ordinance of the law. (Note that the complementary export controls are inapplicable to any application-specific products, except rockets and pilotless aircraft, that are insusceptible to design or program changes.) Accordingly, when exporting or carrying abroad this product, follow the Foreign Exchange and Foreign Trade Control Law and its related regulations with respect to the complementary export controls.
4. The technical information described in this document shows typical characteristics and example application circuits for the products. The release of such information is not to be construed as a warranty of or a grant of license under our or any third party's intellectual property rights or any other rights.
5. The products listed in this document are intended and designed for use as general electronic components in standard applications (office equipment, telecommunication equipment, measuring instruments, consumer electronic products, amusement equipment etc.). Those customers intending to use a product in an application requiring extreme quality and reliability, for example, in a highly specific application where the failure or misoperation of the product could result in human injury or death should first contact us.
  - Aerospace Equipment
  - Equipment Used in the Deep Sea
  - Power Generator Control Equipment (nuclear, steam, hydraulic, etc.)
  - Life Maintenance Medical Equipment
  - Fire Alarms / Intruder Detectors
  - Vehicle Control Equipment (automotive, airplane, railroad, ship, etc.)
  - Various Safety Devices
  - Traffic control system
  - Combustion equipment

In case your company desires to use this product for any applications other than general electronic equipment mentioned above, make sure to contact our company in advance. Note that the important requirements mentioned in this section are not applicable to cases where operation requirements such as application conditions are confirmed by our company in writing after consultation with your company.

6. We are making our continuous effort to improve the quality and reliability of our products, but semiconductor products are likely to fail with certain probability. In order to prevent any injury to persons or damages to property resulting from such failure, customers should be careful enough to incorporate safety measures in their design, such as redundancy feature, fire containment feature and fail-safe feature. We do not assume any liability or responsibility for any loss or damage arising from misuse or inappropriate use of the products.
7. The products have been designed and tested to function within controlled environmental conditions. Do not use products under conditions that deviate from methods or applications specified in this datasheet. Failure to employ the products in the proper applications can lead to deterioration, destruction or failure of the products. We shall not be responsible for any bodily injury, fires or accident, property damage or any consequential damages resulting from misuse or misapplication of the products.
8. **Quality Warranty**
  - 8-1. **Quality Warranty Period**

In the case of a product purchased through an authorized distributor or directly from us, the warranty period for this product shall be one (1) year after delivery to your company. For defective products that occurred during this period, we will take the quality warranty measures described in section 8-2. However, if there is an agreement on the warranty period in the basic transaction agreement, quality assurance agreement, delivery specifications, etc., it shall be followed.
  - 8-2. **Quality Warranty Remedies**

When it has been proved defective due to manufacturing factors as a result of defect analysis by us, we will either deliver a substitute for the defective product or refund the purchase price of the defective product.  
Note that such delivery or refund is sole and exclusive remedies to your company for the defective product.
  - 8-3. **Remedies after Quality Warranty Period**

With respect to any defect of this product found after the quality warranty period, the defect will be analyzed by us. On the basis of the defect analysis results, the scope and amounts of damage shall be determined by mutual agreement of both parties. Then we will deal with upper limit in Section 8-2. This provision is not intended to limit any legal rights of your company.
9. Anti-radiation design is not implemented in the products described in this document.
10. The X-ray exposure can influence functions and characteristics of the products. Confirm the product functions and characteristics in the evaluation stage.
11. WLCSP products should be used in light shielded environments. The light exposure can influence functions and characteristics of the products under operation or storage.
12. Warning for handling Gallium and Arsenic (GaAs) products (Applying to GaAs MMIC, Photo Reflector). These products use Gallium (Ga) and Arsenic (As) which are specified as poisonous chemicals by law. For the prevention of a hazard, do not burn, destroy, or process chemically to make them as gas or power. When the product is disposed of, please follow the related regulation and do not mix this with general industrial waste or household waste.
13. Please contact our sales representatives should you have any questions or comments concerning the products or the technical information.



**Nisshinbo Micro Devices Inc.**

**Official website**

<https://www.nisshinbo-microdevices.co.jp/en/>

**Purchase information**

<https://www.nisshinbo-microdevices.co.jp/en/buy/>