

Product data sheet

Specifications



Limit switch, Limit switches XC Standard, XCKD, plunger, 2NC + NO, ATEX/IECEX

XCKD39H0P16EX

Main

Range of product	Telemecanique Limit switches XC Standard
Series name	Standard format
Product or component type	Limit switch
Device short name	XCKD
Sensor design	Compact
Body type	Fixed
Head type	M18 plunger head
Material	Metal
Fixing mode	By the head
Movement of operating head	Linear
Type of operator	Spring return plunger metal
Switch actuation	On end
Type of approach	Vertical approach, 1 direction
Electrical connection	Screw-clamp terminals, clamping capacity: 1 x 0.34...2 x 0.75 mm ²
Cable entry number	1 tapped entry for M16 x 1.5 cable gland (included) 4...8 mm
Number of poles	3
Contacts type and composition	2 NC + 1 NO
Contacts insulation form	Zb
Contact operation	Snap action
Number of steps	1
Positive opening	With
Minimum force for tripping	15 N
Maximum actuation speed	0.5 m/s
IP degree of protection	IP66 conforming to IEC 60529 IP67 conforming to IEC 60529

Complementary

Body material	Zamak
Head material	Zamak

Positive opening minimum force	45 N
Minimum actuation speed	0.01 m/min
Contact code designation	B300, AC-15 (U _e = 240 V), I _e = 1.5 A conforming to EN 60947-5-1 B300, AC-15 (U _e = 240 V), I _e = 1.5 A conforming to IEC 60947-5-1 appendix A R300, DC-13 (U _e = 250 V), I _e = 0.1 A conforming to EN 60947-5-1 R300, DC-13 (U _e = 250 V), I _e = 0.1 A conforming to IEC 60947-5-1 appendix A
[I_{th}e] conventional enclosed thermal current	6 A AC
[U_i] rated insulation voltage	300 V conforming to UL 508 400 V (pollution degree 3) conforming to IEC 60947-1 300 V conforming to CSA C22.2 No 14
Maximum resistance across terminals	25 MOhm conforming to IEC 60255-7 category 3
[U_{imp}] rated impulse withstand voltage	4 kV conforming to IEC 60664 4 kV conforming to IEC 60947-1
Short-circuit protection	6 A cartridge fuse, type gG
Electrical durability	5000000 cycles, DC-13, inductive load type, 120 V, 2 W, operating rate <3600 cyc/mn, load factor: 0.5, DC conforming to IEC 60947-5-1 appendix C 5000000 cycles, DC-13, inductive load type, 24 V, 4 W, operating rate <3600 cyc/mn, load factor: 0.5, DC conforming to IEC 60947-5-1 appendix C 5000000 cycles, DC-13, inductive load type, 48 V, 3 W, operating rate <3600 cyc/mn, load factor: 0.5, DC conforming to IEC 60947-5-1 appendix C
Mechanical durability	10000000 cycles
Marking	II2 D-Ex tb IIIC T85°C Db IP66/67
Width	31 mm
Height	65 mm
Depth	30 mm

Environment

Shock resistance	50 gn for 11 ms conforming to IEC 60068-2-27
Vibration resistance	25 gn (f= 10...500 Hz) conforming to IEC 60068-2-6
Electrical shock protection class	Class I conforming to IEC 61140 Class I conforming to NF C 20-030
Ambient air temperature for operation	-20...60 °C
Protective treatment	TC
Dust zone	Zone 21 - 22
Product certifications	INERIS 04ATEX0014X IEC-Ex INE 17.0020X
Standards	EN/IEC 60079-31 EN/IEC 60079-0
Directives	2014/34/EU - ATEX directive

Packing Units

Unit Type of Package 1	PCE
Number of Units in Package 1	1
Package 1 Height	15 cm
Package 1 Width	14 cm
Package 1 Length	5 cm
Package 1 Weight	211 g

Offer Sustainability

Sustainable offer status	Green Premium product
---------------------------------	-----------------------

REACH Regulation	REACH Declaration
EU RoHS Directive	Pro-active compliance (Product out of EU RoHS legal scope)
Mercury free	Yes
RoHS exemption information	Yes
Environmental Disclosure	Product Environmental Profile
Circularity Profile	No need of specific recycling operations
California proposition 65	WARNING: This product can expose you to chemicals including: Diisononyl phthalate (DINP), which is known to the State of California to cause cancer, and Di-isodecyl phthalate (DIDP), which is known to the State of California to cause birth defects or other reproductive harm. For more information go to www.P65Warnings.ca.gov

Contractual warranty

Warranty	18 months
-----------------	-----------

Dimensions

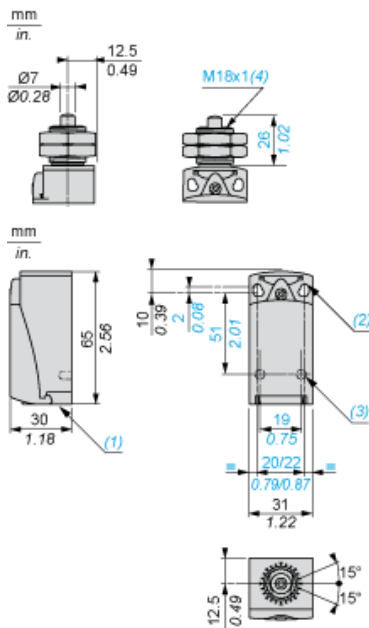

- (1) Tapped entry for M16 x 1.5
- (2) 2 elongated holes Ø 4.3 x 6.3 mm on 22 mm centres, 2 holes Ø 4.3 on 20 mm centres.
- (3) 2 x Ø 3 holes for support studs, depth 4 mm.
- (4) Fixing nut thickness 3.5 mm.

Mounting with Cable Entry

Position of Cable Gland

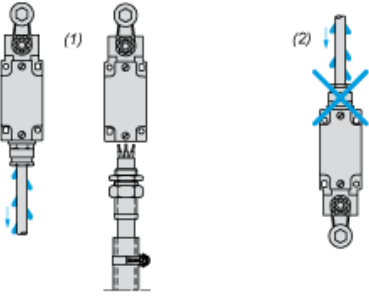

- (1) Recommended
- (2) To be avoided

Panel Mounting

Mounting and Fixing Limit Switches by the Head

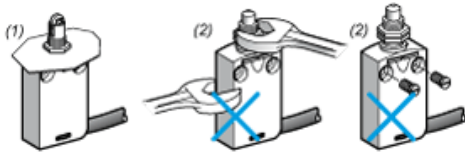

- (1) Recommended
- (2) Forbidden

Setting-up

Plunger or Multi-directional Heads

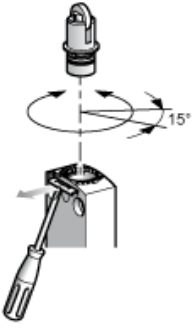

Wiring Diagram

3-pole NC + NC + NO Snap Action

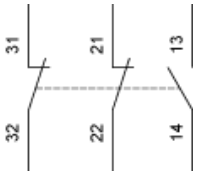

Characteristics of Actuation

Switch Actuation on End

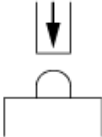

Functionnal Diagram

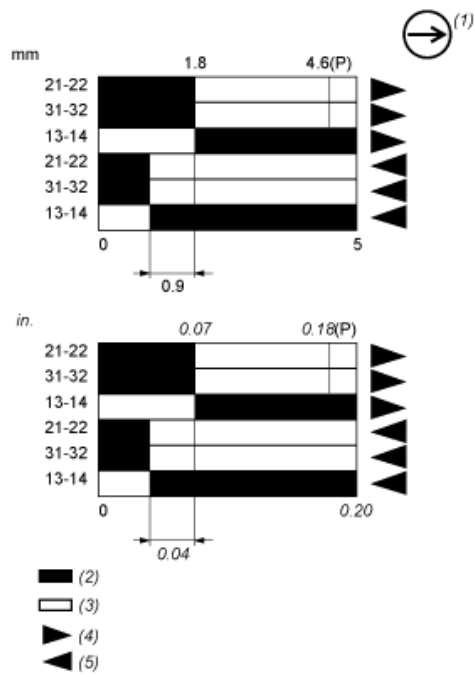

- (P) Positive opening point
- (1) NC contact with positive opening operation
- (2) Closed
- (3) Open
- (4) Tripping
- (5) Resetting

Recommended replacement(s)