



MTA 156

TE Internal #: 643495-2

Rectangular Power Connectors, Header, Plug, Wire-to-Board, 5 Position, 3.96 mm [.156 in] Centerline, Printed Circuit Board, UL 94V-0, MTA 156

[View on TE.com >](#)

Connectors > Power Connectors > Rectangular Power > Rectangular Power Connectors

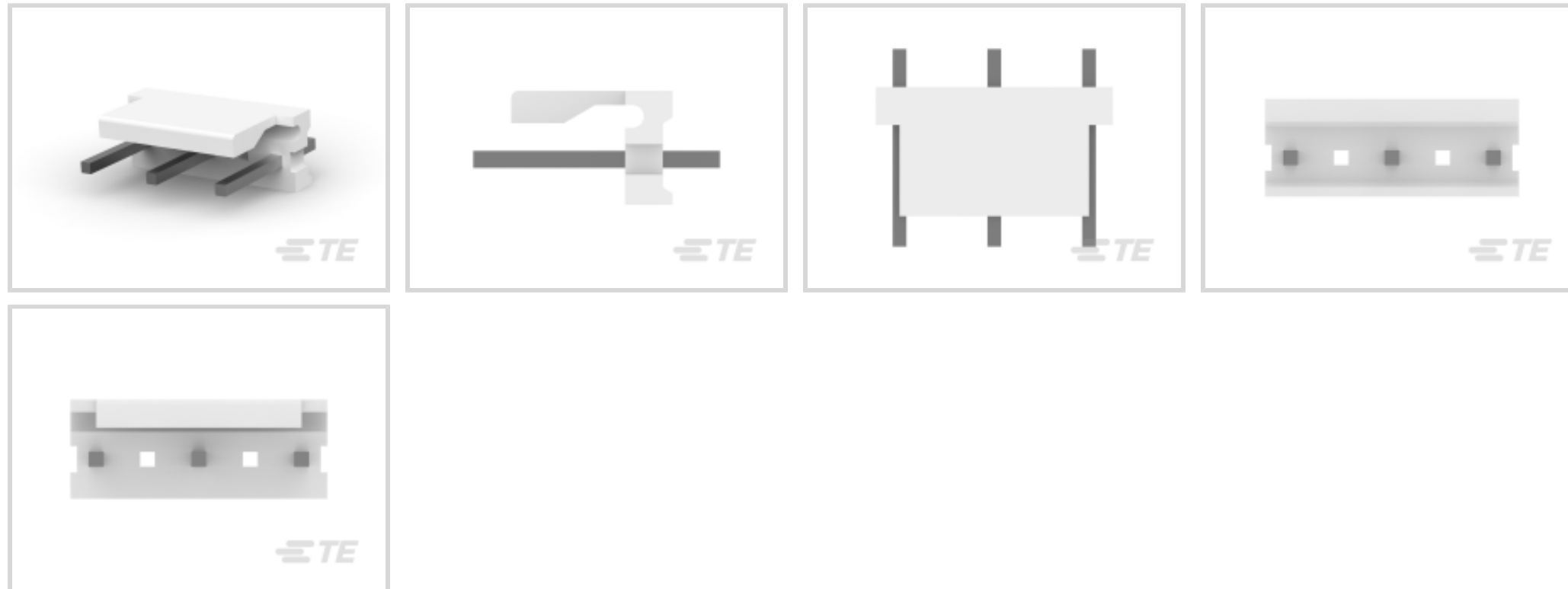

Rectangular Power Connector Type: **Header**

Connector & Housing Type: **Plug**

Connector System: **Wire-to-Board**

Number of Positions: **5**

Centerline (Pitch): **3.96 mm [.156 in]**

Features

Product Type Features

Header Type	Partially Shrouded
Rectangular Power Connector Type	Header
Connector & Housing Type	Plug
Connector System	Wire-to-Board
Sealable	No
Connector & Contact Terminates To	Printed Circuit Board

Configuration Features

Number of Loaded Positions	3
Number of Positions	5
PCB Mount Orientation	Vertical
Number of Power Positions	5
Number of Signal Positions	0
Number of Rows	1

Electrical Characteristics



Operating Voltage	600 VAC
-------------------	---------

Contact Features

Mating Post Length	10.16 mm[.4 in]
--------------------	-----------------

Contact Layout	Inline
----------------	--------

Contact Mating Area Plating Material	Tin
--------------------------------------	-----

Contact Underplating Material	Nickel
-------------------------------	--------

Contact Base Material	Copper Alloy
-----------------------	--------------

Contact Current Rating (Max)	7 A
------------------------------	-----

Contact Retention Within Housing	Without
----------------------------------	---------

Contact Type	Pin
--------------	-----

PCB Contact Termination Area Plating Material	Tin
---	-----

Contact Mating Area Plating Material Thickness	2.54 μ m[100 μ in]
--	----------------------------

Termination Features

Termination Post & Tail Length	3.81 mm[.15 in]
--------------------------------	-----------------

Termination Method to Printed Circuit Board	Through Hole - Solder
---	-----------------------

Mechanical Attachment

Strain Relief	Without
---------------	---------

Mating Retention	With
------------------	------

Mating Alignment	Without
------------------	---------

PCB Mount Alignment	Without
---------------------	---------

Panel Mount Feature	Without
---------------------	---------

PCB Mount Retention	Without
---------------------	---------

Mating Retention Type	Friction Lock
-----------------------	---------------

Connector Mounting Type	Board Mount
-------------------------	-------------

Housing Features

Centerline (Pitch)	3.96 mm[.156 in]
--------------------	------------------

Housing Color	Natural
---------------	---------

Housing Material	Thermoplastic Polyester
------------------	-------------------------

Dimensions

Connector Height	10.8 mm
------------------	---------

PCB Thickness (Recommended)	3.48 mm[.12 in]
-----------------------------	-----------------

Product Length	19.81 mm
----------------	----------



Usage Conditions

Operating Temperature Range	-55 – 105 °C[-67 – 221 °F]
-----------------------------	----------------------------

Operation/Application

Circuit Application	Power
---------------------	-------

Industry Standards

CSA Rating	Certified, LR 7189
UL Rating	Recognized
Agency/Standard	CSA, UL
Approved Standards	UL E28476
UL Flammability Rating	UL 94V-0
Glow Wire Rating	Standard Part - Not Glow Wire

Packaging Features

Packaging Quantity	1000
Packaging Method	Package

Other

Number of Blocked Positions	2
-----------------------------	---

Product Compliance

[For compliance documentation, visit the product page on TE.com>](#)

EU RoHS Directive 2011/65/EU	Compliant
EU ELV Directive 2000/53/EC	Compliant
China RoHS 2 Directive MIIT Order No 32, 2016	No Restricted Materials Above Threshold
EU REACH Regulation (EC) No. 1907/2006	Current ECHA Candidate List: JUNE 2023 (235) Candidate List Declared Against: JUNE 2023 (235) Does not contain REACH SVHC
Halogen Content	Not Low Halogen - contains Br or Cl > 900 ppm.
Solder Process Capability	Wave solder capable to 265°C

Product Compliance Disclaimer

This information is provided based on reasonable inquiry of our suppliers and represents our current actual knowledge based on the information they provided. This information is subject to change. The part numbers that TE has identified as EU RoHS compliant have a maximum concentration of 0.1% by weight in homogenous materials for lead, hexavalent chromium, mercury, PBB, PBDE, DBP, BBP, DEHP, DIBP, and 0.01% for cadmium, or qualify for an exemption to these limits as defined in the Annexes of Directive 2011/65/EU (RoHS2). Finished electrical and electronic equipment products

will be CE marked as required by Directive 2011/65/EU. Components may not be CE marked. Additionally, the part numbers that TE has identified as EU ELV compliant have a maximum concentration of 0.1% by weight in homogenous materials for lead, hexavalent chromium, and mercury, and 0.01% for cadmium, or qualify for an exemption to these limits as defined in the Annexes of Directive 2000/53/EC (ELV). Regarding the REACH Regulation, the information TE provides on SVHC in articles for this part number is based on the latest European Chemicals Agency (ECHA) 'Guidance on requirements for substances in articles' posted at this URL: <https://echa.europa.eu/guidance-documents/guidance-on-reach>

Compatible Parts



TE Part # CAT-103156-WBHSM
Receptacle Housing: Wire-to-Board,
with Mating Alignment, SL156



TE Part # 3-640433-5
05P MTA156 CONN ASSY 22AWG RED



TE Part # 3-640427-5
05P MTA156 CONN ASSY 20AWG YEL



TE Part # 640629-1
MTA156 KEYING PLUG



TE Part # 3-640601-5
05P MTA156 CONN ASSY 22AWG LF



TE Part # 3-644468-5
05P MTA156 CONN ASSY 24AWG LF



TE Part # 3-644759-5
05P MTA156 HDR ASSY STR LF



TE Part # 3-644860-5
05P MTA156 CONN ASSY 18AWG LF

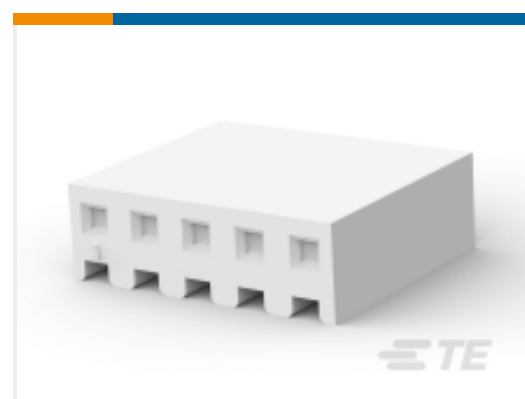

TE Part # 640251-5
05P SL156 HSG W/O LCK RAMP



TE Part # 647344-5
05P SL156 HSG W/RP TB BLK #3



TE Part # 640551-5
05P MTA156 COVER



TE Part # 3-640431-5
05P MTA156 CONN ASSY 18AWG
ORA



TE Part # 3-644461-5
05P MTA156 CONN ASSY 18AWG LF



TE Part # 3-641150-5
05P MTA156 ASSY 22AWG RED LF



TE Part # 3-640428-5
05P MTA156 CONN ASSY 22AWG RED



TE Part # 3-643818-5
05P MTA156 CONN ASSY 20AWG YEL



Also in the Series | MTA 156

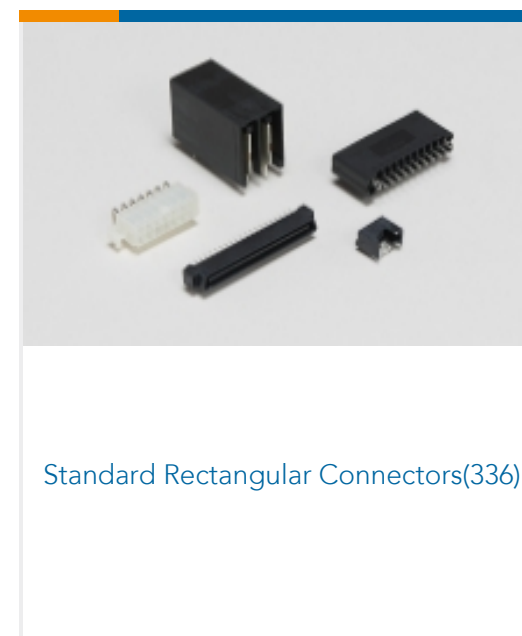
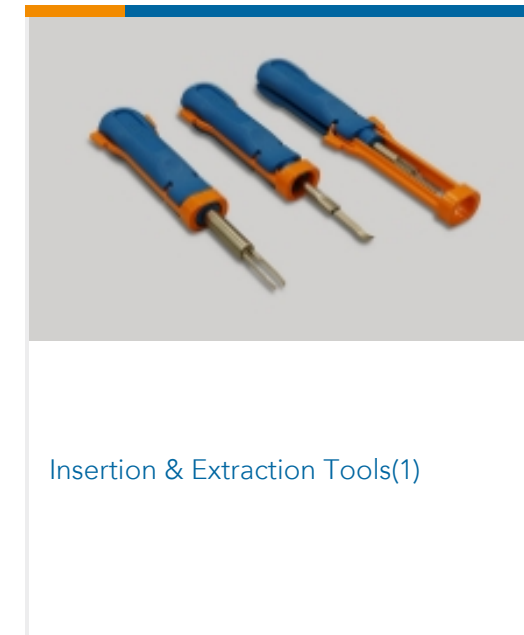
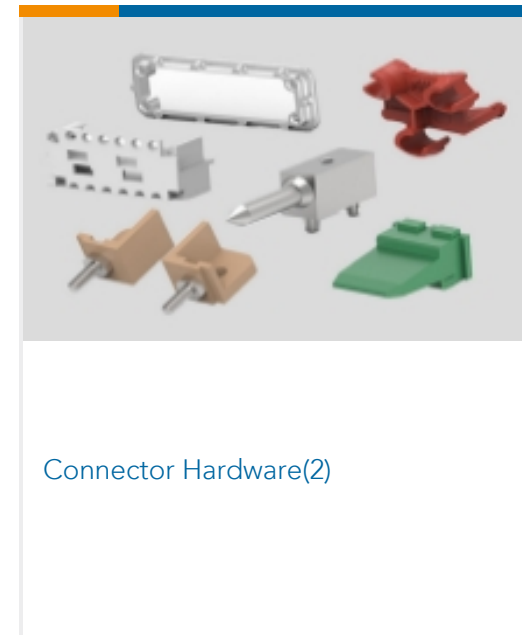
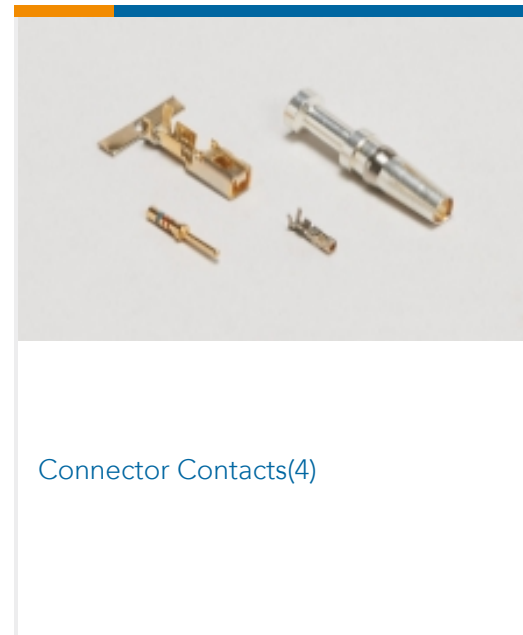

Customers Also Bought

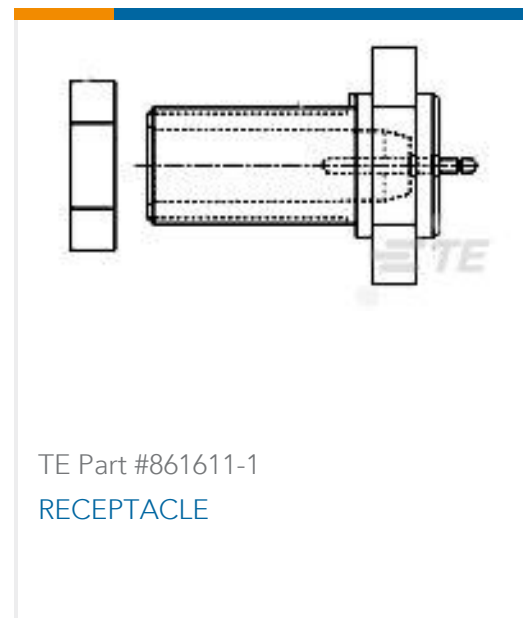



TE Part #696422-4
PIDG PVF2 R 22-16COM22-18MIL 6

Documents

Product Drawings

[05P MTA156 HDR ASSY W/O#2&4](#)

English

CAD Files

Customer View Model

[ENG_CVM_CVM_643495-2_R.2d_dxf.zip](#)

English

[3D PDF](#)

3D

Customer View Model

[ENG_CVM_CVM_643495-2_R.3d_igs.zip](#)

English

Customer View Model

[ENG_CVM_CVM_643495-2_R.3d_stp.zip](#)

English

By downloading the CAD file I accept and agree to the [Terms and Conditions](#) of use.

Product Specifications

[Application Specification](#)

English

Product Environmental Compliance

[Product Compliance Document](#)

English

[Product Compliance Document](#)

English

Agency Approvals

[Agency Approval Document](#)

English