



FEATURES

- Ultra-High Optical Output
- Four Wire Bonds on Die Corners
- Very Uniform Optical Beam
- Standard 3-Lead TO-39 Hermetic Package
- Chip Size: 0.026" x 0.026"

Electro-Optical Characteristics at 25°C

Parameters	Test Conditions	Min	Typ	Max	Units
Total Power Output, P_o	$I_F = 500 \text{ mA}$	80	140		mW
Peak Emission Wavelength, λ_P	$I_F = 50 \text{ mA}$		850		nm
Spectral Bandwidth at 50%, $\Delta\lambda$	$I_F = 50 \text{ mA}$		40		nm
Half Intensity Beam Angle, θ	$I_F = 50 \text{ mA}$		110		Deg
Forward Voltage, V_F	$I_F = 500 \text{ mA}$		1.7	2	Volts
Reverse Breakdown Voltage, V_R	$I_R = 10 \mu\text{A}$	5	30		Volts
Rise Time	$I_{FP} = 50 \text{ mA}$		20		nsec
Fall Time	$I_{FP} = 50 \text{ mA}$		20		nsec

Absolute Maximum Ratings at 25°C Case

Parameters	Units
Power Dissipation ¹	1000 mW
Continuous Forward Current	500 mA
Peak Forward Current (10 μs , 200 Hz) ²	1.5 A
Reverse Voltage	5 V
Lead Soldering Temperature (1/16" from case for 10 sec)	260°C

¹ Derate per thermal derating curve above 25°C.

² Derate linearly above 25°C.

Thermal Parameters

Parameters	Units
Storage and Operating Temperature Range	-40°C to 100°C
Maximum Junction Temperature	100°C
Thermal Resistance, R_{THJA} ¹	145°C/W Typical
Thermal Resistance, R_{THJA} ²	75°C/W Typical

¹ Heat transfer minimized by measuring in still air with minimum heat conducting through leads.

² Air circulating at a rapid rate to keep case temperature at 25°C.

Maximum Rated Thermal Derating Curve

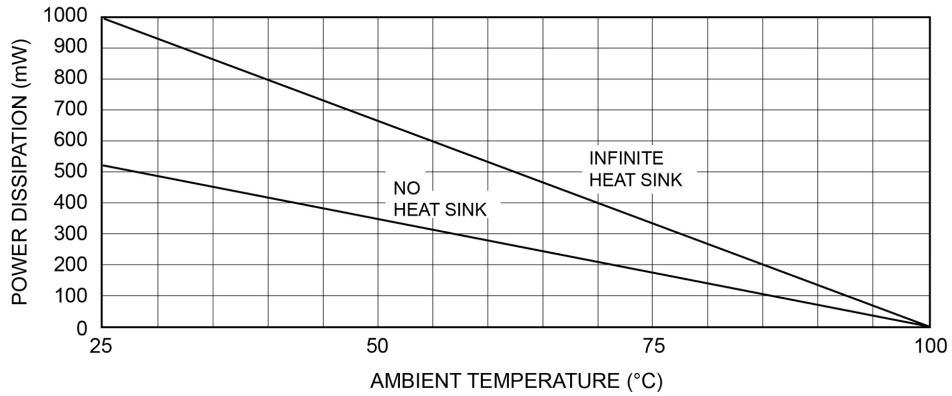

Typical Degradation Curve

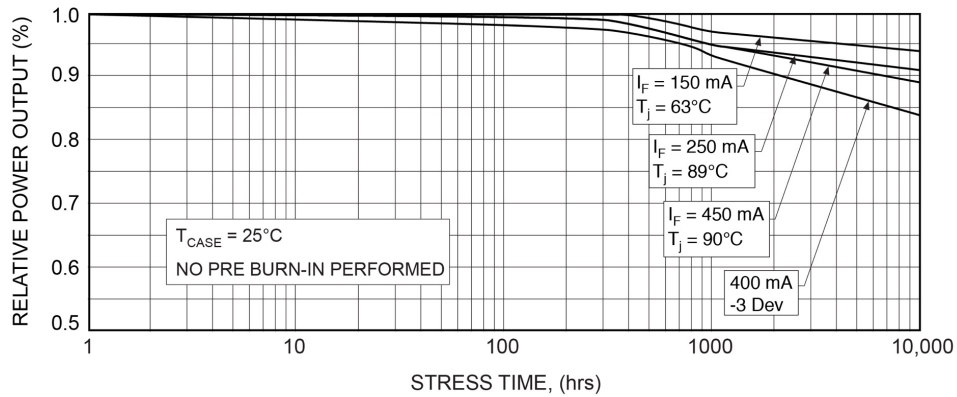

Typical Radiation Pattern

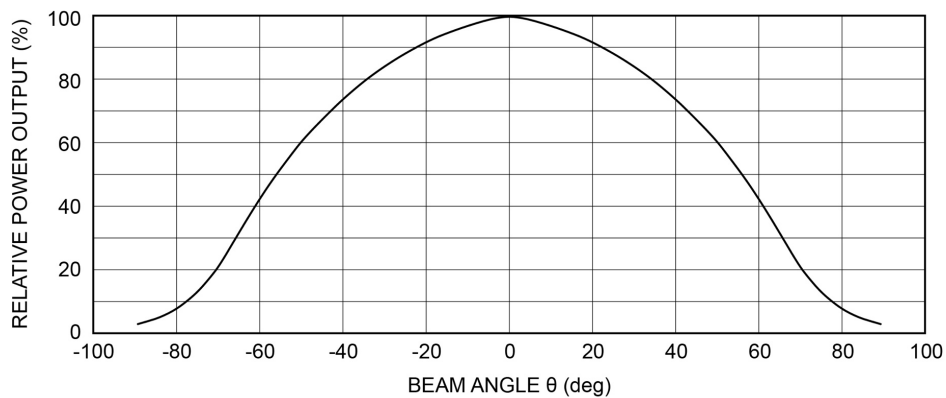

Typical Spectral Output

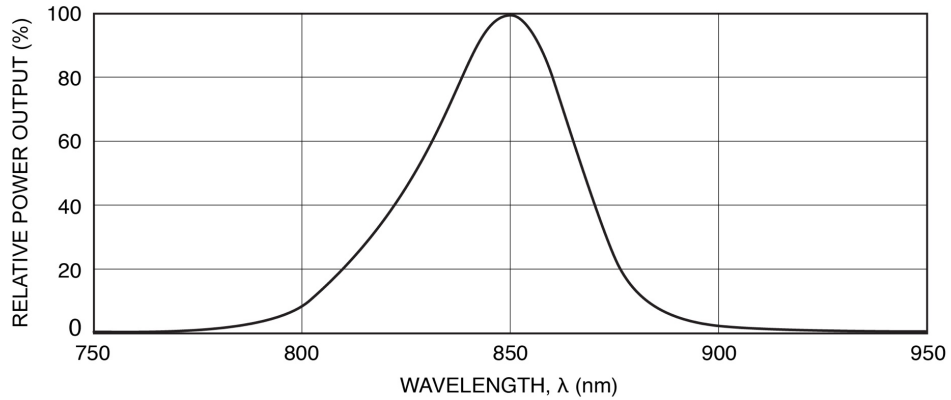

Typical Power Output vs Temperature

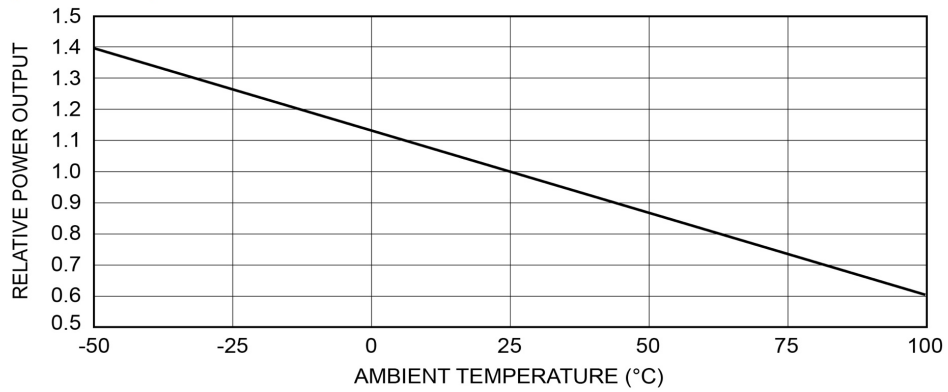

Typical Power Output vs Forward Current

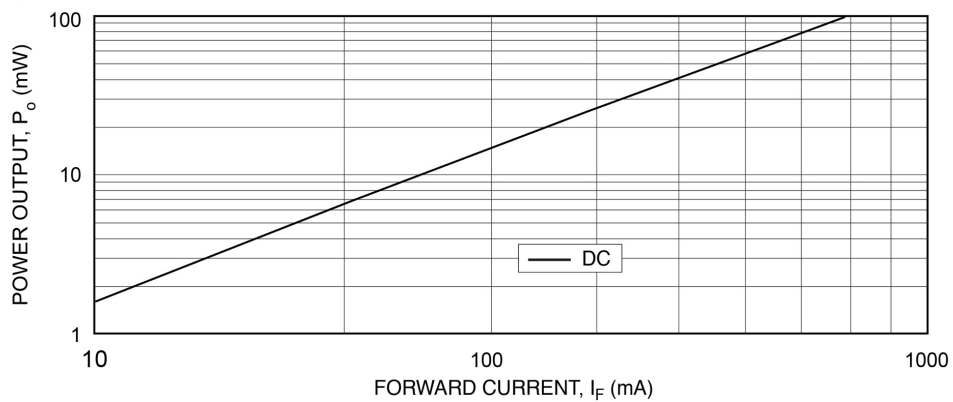

Package Information

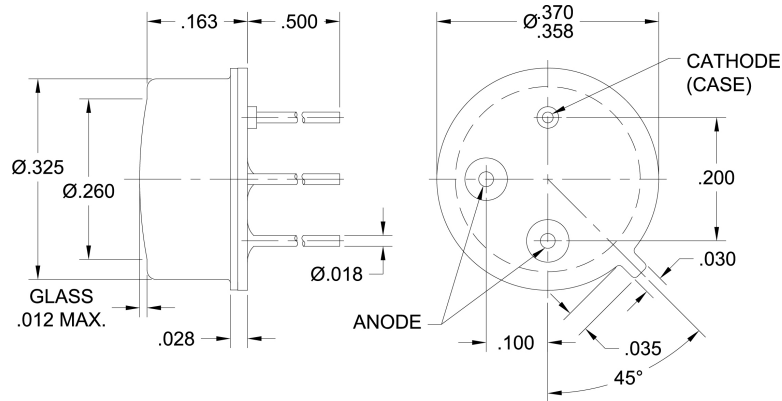

All surfaces are gold plated. Dimensions are nominal values in inches unless otherwise specified. Two Anode pins **must be** externally connected together.

Specifications are subject to change without prior notice.