

Description

The AP7375Q series is a wide input voltage range (45V), low quiescent current (2.1µA), low-dropout linear regulator (LDO) able to provide 300mA load current. The AP7375Q family of LDOs offers an EN pin to enable and disable the LDO output. The EN pin can take an input voltage of 45V.

The device provides a very fast response against line voltage transient and load current transient, and ensures no overshoot voltage occurs during start up and short-circuit recovery. It also features integrated short-circuit and thermal-shutdown protection.

The AP7375Q has 1.8V, 3.0V, 3.3V, and 5.0V fixed output voltage versions, and is available in the SOT89, SO-8EP, SOT25, SOT25R and U-DFN2020-6 (SWP) (Type UXC) packages.

Features

- Wide Input Voltage Range: 3V to 45V
- Maximum Output Current: 300mA
- Low Dropout Voltage:
 $V_{DROP} = 35mV @ I_{OUT} = 10mA$ (Typ.)
 $V_{DROP} = 350mV @ I_{OUT} = 100mA$ (Typ.)
- Low Quiescent Current: 2.1µA (Typ.)
- Fixed Output Voltages: 1.8V, 3.0V, 3.3V and 5.0V
- High Output Voltage Accuracy: $\pm 2\%$
- High PSRR: 85dB@1kHz
- Excellent Line/Load Regulation
- Thermal Shutdown Function
- Short-Current Protection Function
- **Totally Lead-Free & Fully RoHS Compliant (Notes 1 & 2)**
- **Halogen and Antimony Free. "Green" Device (Note 3)**
- **The AP7375Q is suitable for automotive applications requiring specific change control; this part is AEC-Q100 qualified, PPAP capable, and manufactured in IATF 16949 certified facilities.**
<https://www.diodes.com/quality/product-definitions/>

Pin Assignments

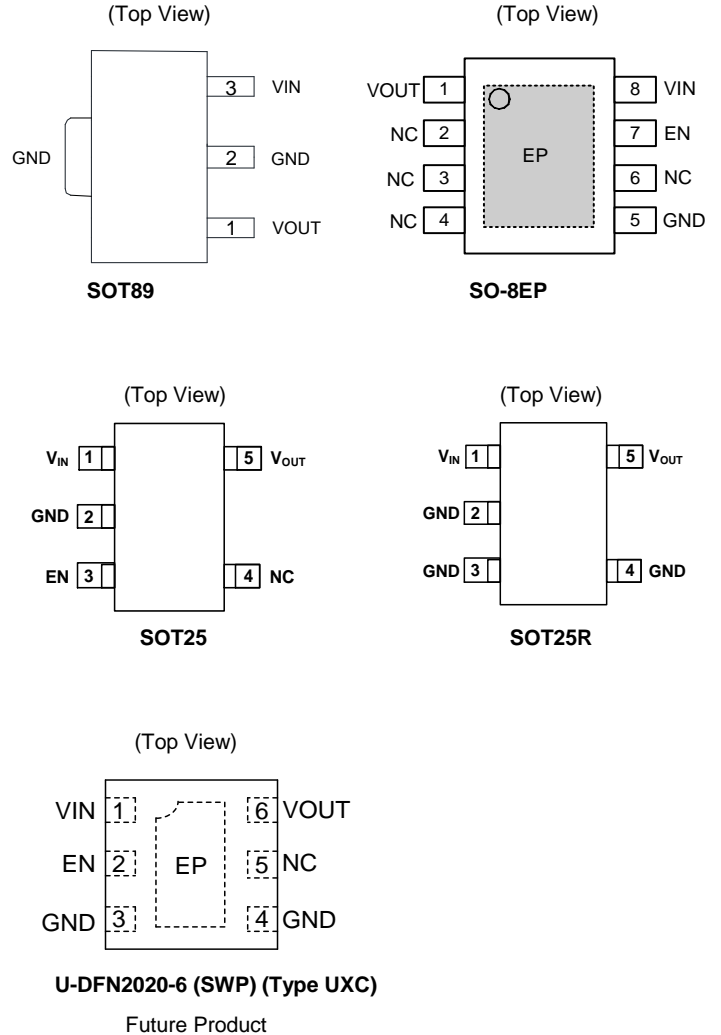

Applications

- Powering MCUs and CAN/LIN transceivers
- Automotive head units
- EV and HEV battery management systems
- Body control modules
- Transmission control units (TCUs)

Notes: 1. No purposely added lead. Fully EU Directive 2002/95/EC (RoHS), 2011/65/EU (RoHS 2) & 2015/863/EU (RoHS 3) compliant.
2. See <https://www.diodes.com/quality/lead-free/> for more information about Diodes Incorporated's definitions of Halogen- and Antimony-free, "Green" and Lead-free.
3. Halogen- and Antimony-free "Green" products are defined as those which contain <900ppm bromine, <900ppm chlorine (<1500ppm total Br + Cl) and <1000ppm antimony compounds.

Typical Applications Circuit

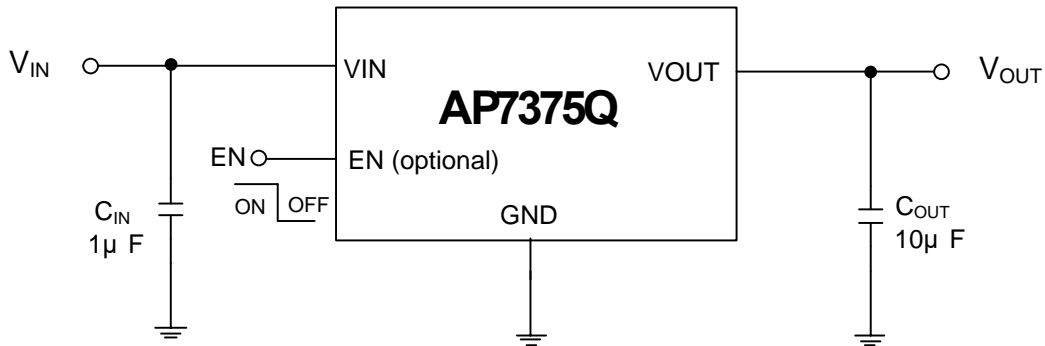

Pin Descriptions

Pin Number					Pin Name	Function
SOT89	SO-8EP	SOT25	SOT25R	U-DFN2020-6 (SWP) (Type UXC)		
3	8	1	1	1	VIN	Input voltage
2	5	2	2, 3, 4	3, 4	GND	Ground
-	7	3	-	2	EN	Enable
1	1	5	5	6	VOUT	Regulated output voltage
-	2, 3, 4, 6	4	-	5	NC	Not Connected internally, recommend connect to GND to maximize PCB copper for thermal dissipation.
-	EP	-	-	-	Expose Pad	In PCB layout, prefer to use large copper area to cover this pad for better thermal dissipation, then connect this area to GND or leave it open. However, do not use it as GND electrode function alone

Functional Block Diagram

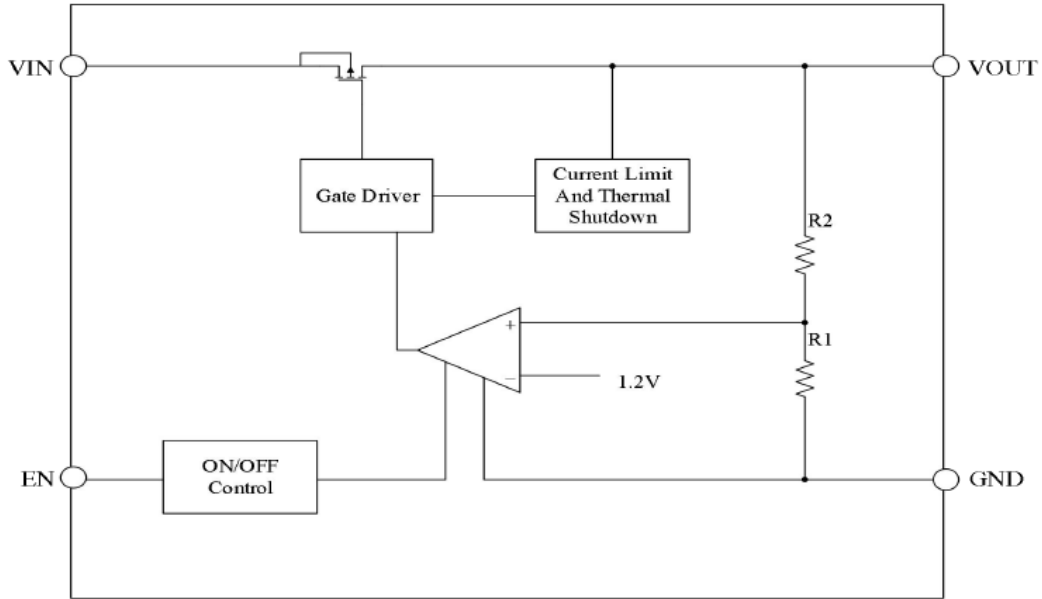

Absolute Maximum Ratings

Symbol	Parameter	Rating	Unit	
V_{IN}	Supply Input Voltage	-0.3 ~ 55	V	
V_{OUT}	Regulated Output Voltage	-0.3 ~ 6	V	
V_{EN}	EN to GND	-0.3 ~ 55	V	
I_{OUT}	Output Current	Internally limited	mA	
T_{LEAD}	Lead Temperature (Soldering, 10sec)	+260	°C	
T_J	Operating Junction Temperature	+150	°C	
T_A	Operating Ambient Temperature	-40 to +125	°C	
θ_{JA}	Thermal Resistance (Junction to Ambient)	SOT89	94.5	°C/W
		SO-8EP	47.7	
		SOT25	135.5	
		U-DFN2020-6 (SWP) (Type UXC)	TBD	
T_{STG}	Storage Temperature Range	-40 to +150	°C	
CDM	ESD (Charge Device Model)	±1.5	kV	
HBM	ESD (Human Body Model)	3	kV	

Note:

4. a). Stresses beyond those listed under Absolute Maximum Ratings may cause permanent damage to the device. These are stress ratings only and functional operation of the device at these conditions is not implied. Exposure to absolute-maximum-rated conditions for extended period may affect device reliability.
- b). Ratings apply to ambient temperature at +25°C. The JEDEC STD.51 High-K board design used to derive this data was a 3 inch x 3 inch multilayer board with 1oz. internal power and ground planes and 2oz. copper traces on the top and bottom of the board.

Recommended Operating Conditions

Symbol	Parameter	Min	Typ	Max	Unit
V _{IN}	Supply Input Voltage	3.0	—	45	V
V _{OUT}	Output Voltage	—	—	5	V
T _J	Operating Junction Temperature	-40	—	+125	°C
C _{IN}	Input Capacitor	—	1	—	μF
C _{OUT}	Output Capacitor	1	10	—	μF

Electrical Characteristics (T_A = -40°C~ 125°C, I_{OUT} = 1mA, C_{IN}=1μF, C_{OUT}=10μF ceramic capacitor, V_{IN} = V_{OUTNOM} +2.0V)

Symbol	Parameter	Test Conditions	Min	Typ	Max	Unit
V _{IN}	Input Voltage	—	3	—	45	V
I _{GND}	Quiescent Current	V _{IN} = 12V, No load	—	2.1	8	μA
V _{OUT}	Output Voltage	V _{IN} = 12V, I _{OUT} = 10 mA	V _{OUT} x98%	—	V _{OUT} x102%	V
I _{OUT_MAX}	Output Current	—	300	350	—	mA
V _{DROP}	Dropout Voltage (Note 5)	I _{OUT} = 10mA, V _{IN} = V _{OUTNOM} - 0.1V	—	35	80	mV
		I _{OUT} = 100mA, V _{IN} = V _{OUTNOM} - 0.1V	—	350	580	mV
		I _{OUT} = 300mA, V _{IN} = V _{OUTNOM} - 0.1V, T _A =25°	—	1200	1400	mV
ΔV _{OUT} (ΔI _{OUT})	Load Regulation (Note 6)	V _{IN} = 12V, 1mA ≤ I _{OUT} ≤ 100mA	—	0.02	0.025	%/mA
ΔV _{OUT} (ΔV _{IN})	Line Regulation	V _{OUTNOM} + 2V ≤ V _{IN} ≤ 45 V, I _{OUT} = 1 mA	—	0.01	0.02	%/V
I _{LIMIT}	Current Limit	—	—	500	—	mA
T _{OTSD}	Thermal Shutdown Temperature	—	—	+150	—	°C
T _{HYOTSD}	Thermal Shutdown Hysteresis	—	—	+10	—	°C
PSRR	Power Supply Rejection Ratio	V _{IN} = 12V, I _{OUT} = 10mA, V _{OUT} = 3.3V@1kHz	—	85	—	dB
V _n	Output Noise Voltage	BW = 10Hz to 100kHz, I _{OUT} = 30mA	—	120	—	μVrms
VENH	EN High Level	Enabled	1	—	—	V
VENL	EN Low Level	Disabled	—	—	0.4	V
θ _{JC}	Thermal Resistance Junction to Case (Note 4)	SOT89	—	43.7	—	°C/W
		SO-8EP	—	17.4	—	
		SOT25	—	36.7	—	
		U-DFN2020-6 (SWP) (Type UXC)	—	TBD	—	

- Note:
4. a). Stresses beyond those listed under Absolute Maximum Ratings may cause permanent damage to the device. These are stress ratings only and functional operation of the device at these conditions is not implied. Exposure to absolute-maximum-rated conditions for extended period may affect device reliability.
 - b). Ratings apply to ambient temperature at +25°C. The JEDEC STD.51 High-K board design used to derive this data was a 3 inch x 3 inch multilayer board with 1oz. internal power and ground planes and 2oz. copper traces on the top and bottom of the board.
 5. Dropout voltage is the voltage difference between the input and output at which the output voltage drops 100mV below its nominal value. This parameter only applies to output voltages above 3.0V since minimum V_{IN} = 3.0V.
 6. The AP7375Q internal circuitry is not fully operational until V_{IN} is at least the greater of 3V or (V_{OUT}+V_{DROPOUT(MAX)}).

Performance Characteristics

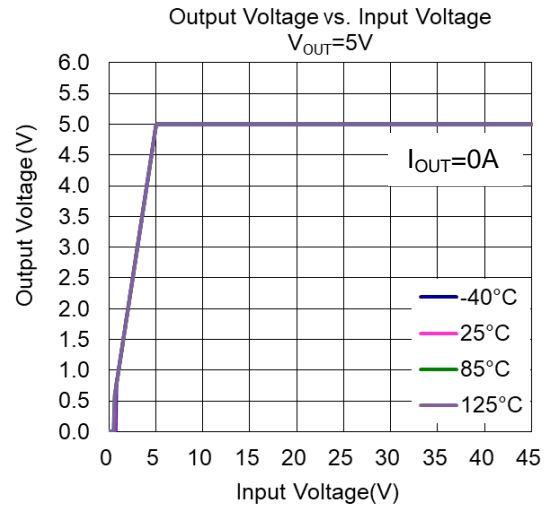
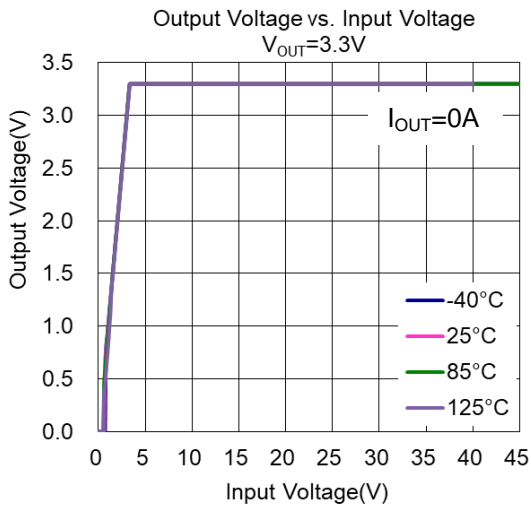
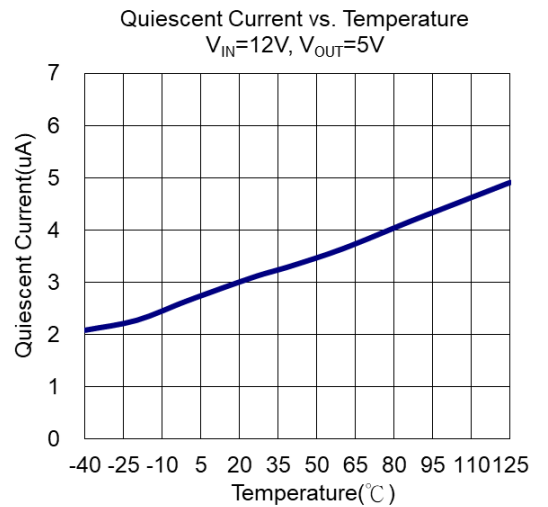
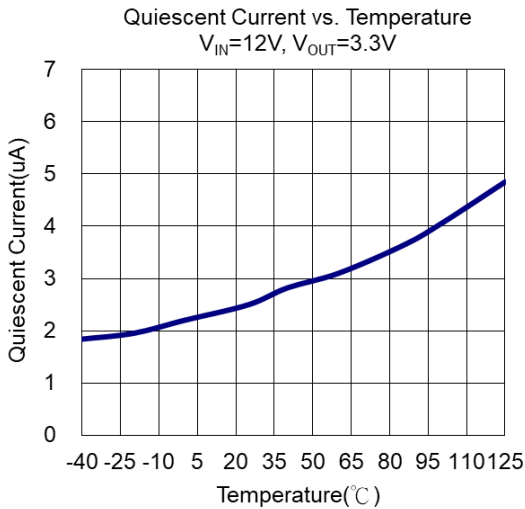
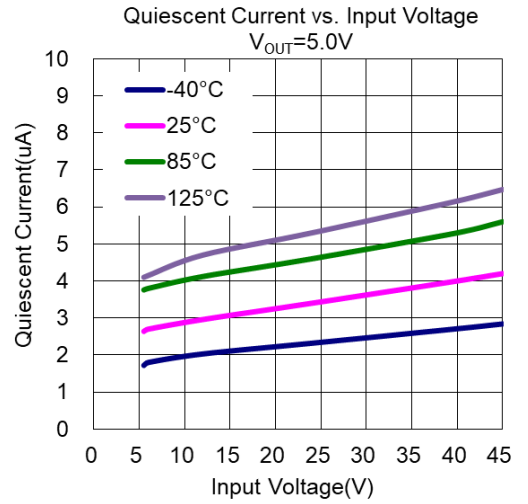
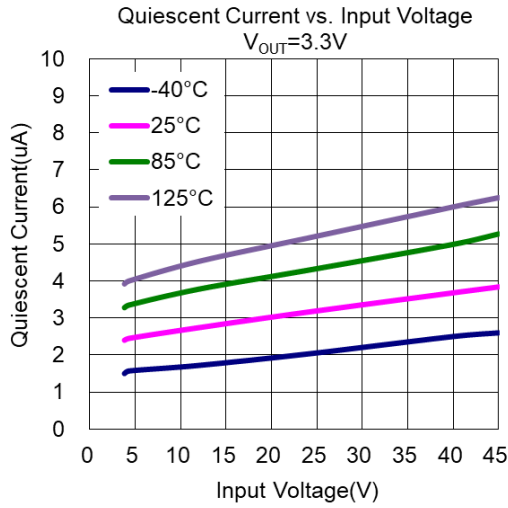

Typical Characteristics

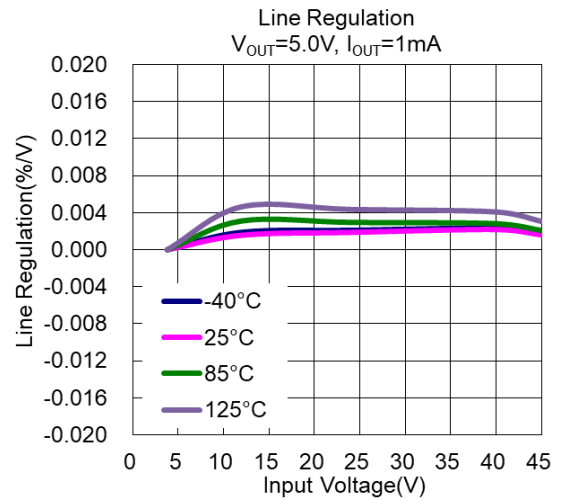
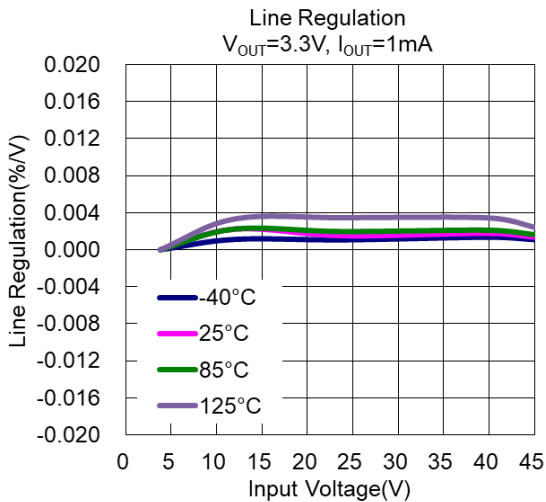
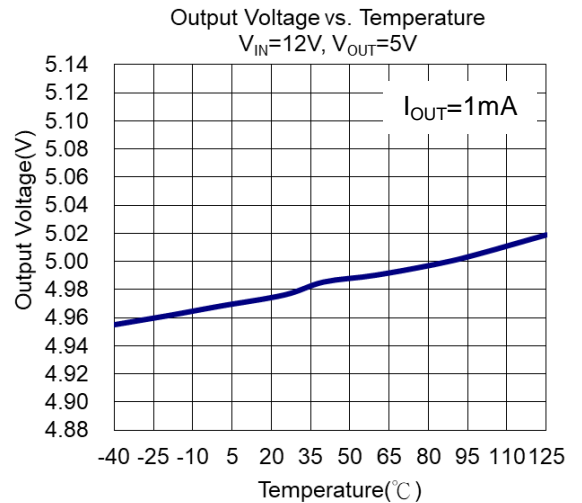
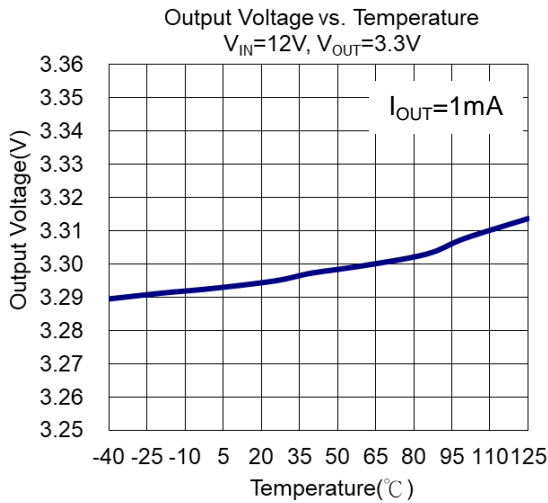
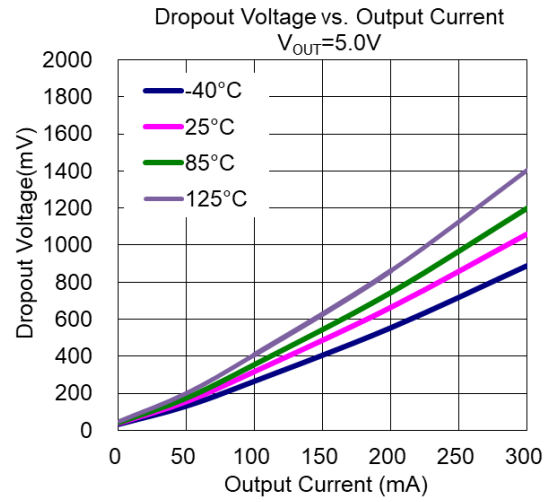
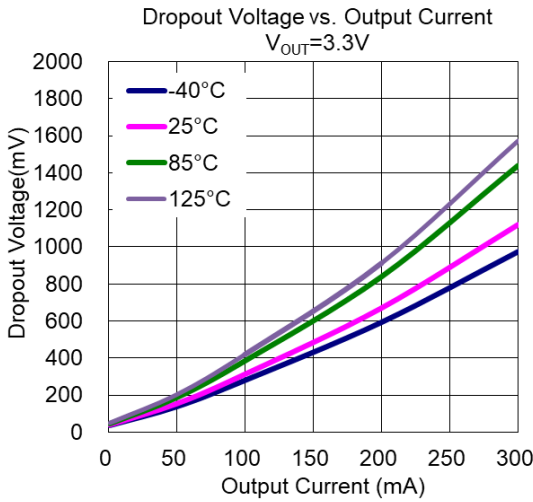

Typical Characteristics (continued)

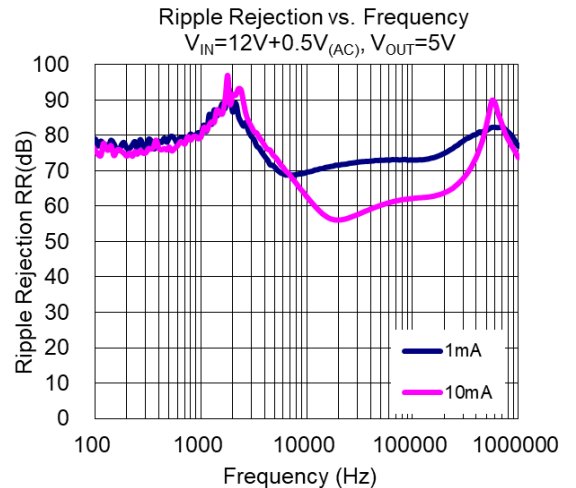
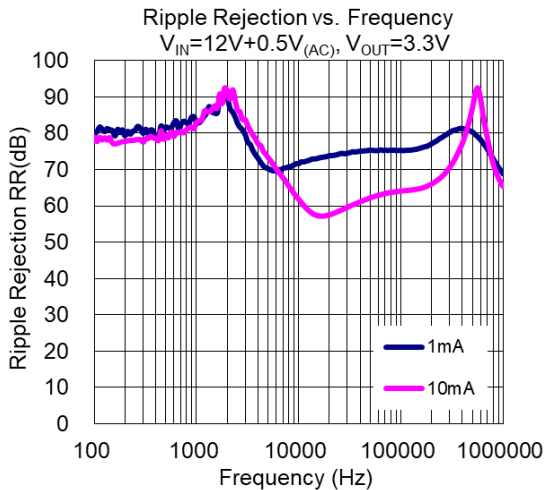
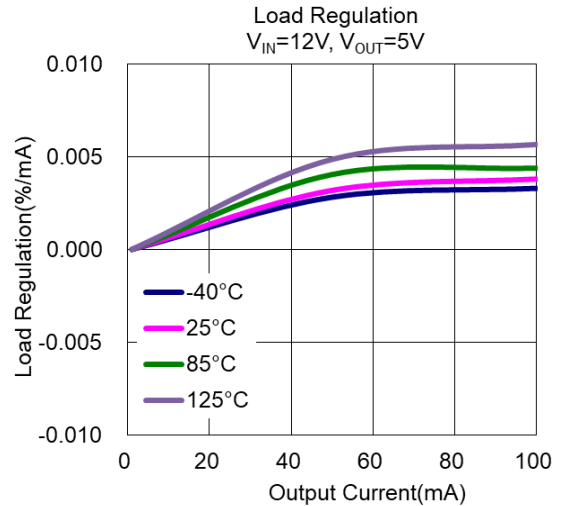
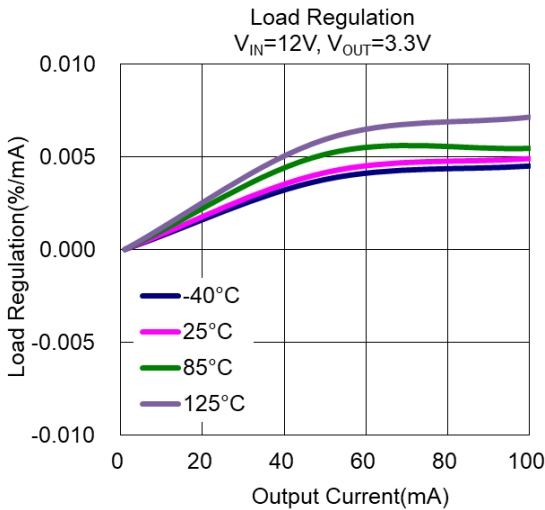
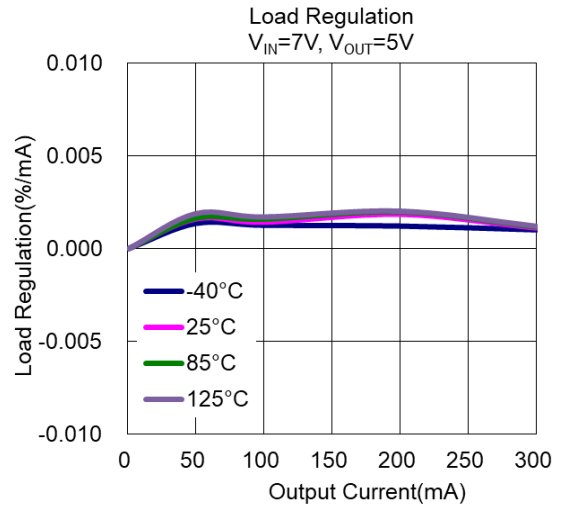
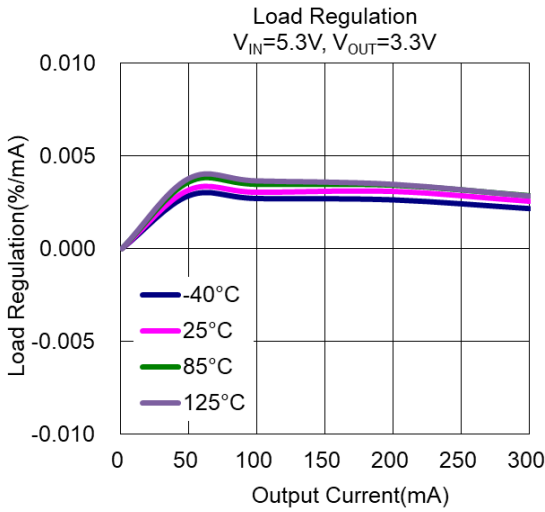

Typical Characteristics (continued)

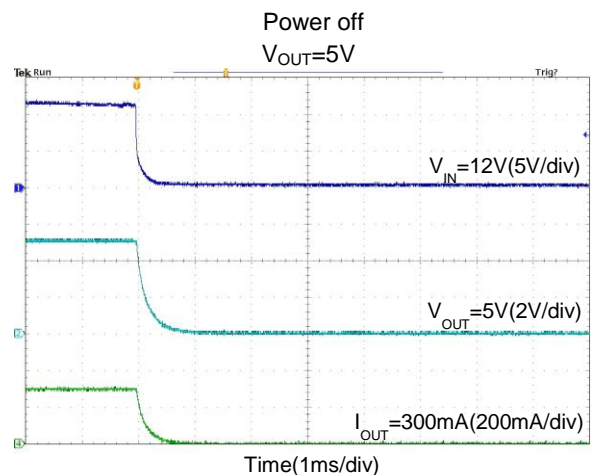
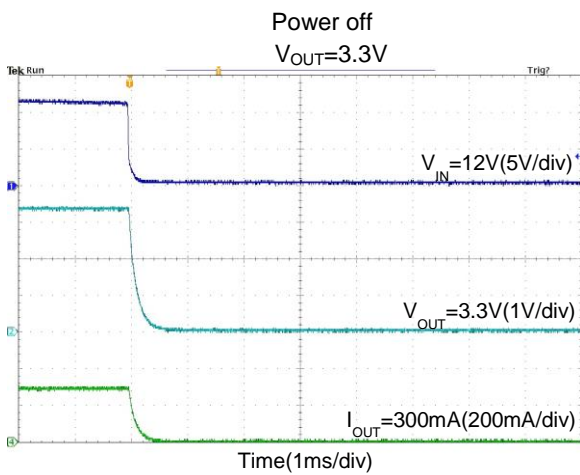
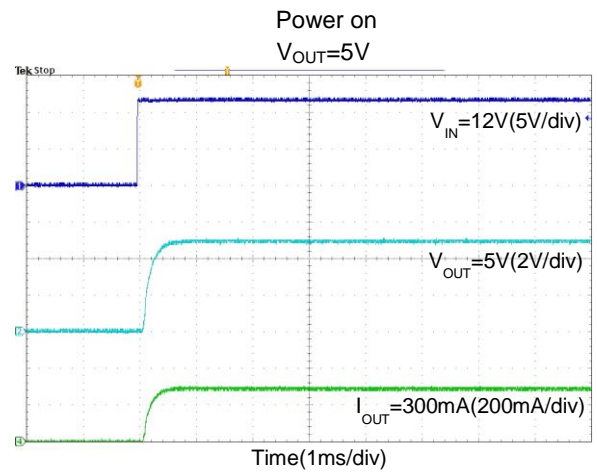
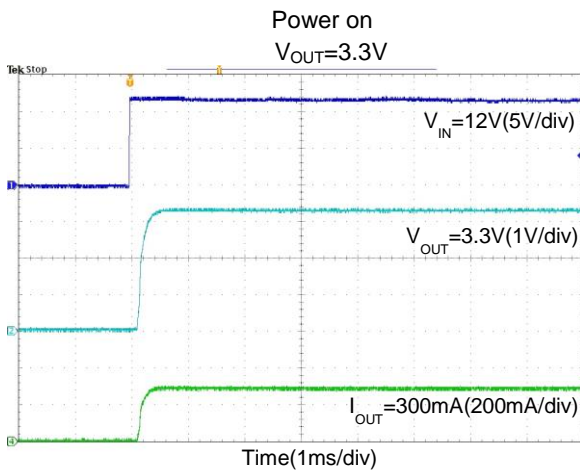
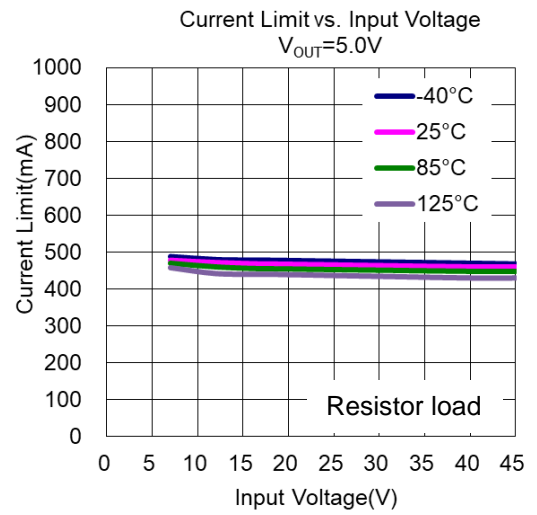
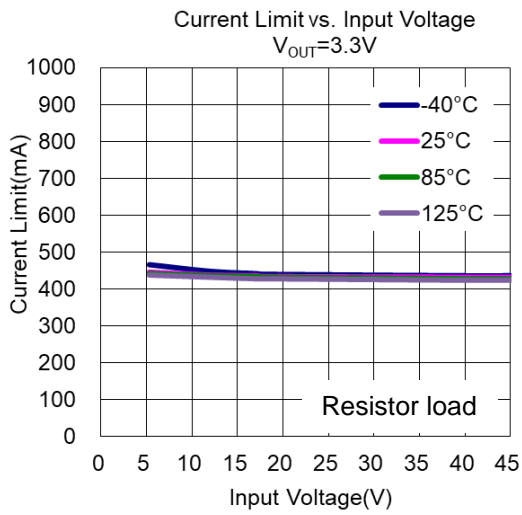

Line Transient Response
 $V_{OUT}=3.3V$

Line Transient Response
 $V_{OUT}=5V$

Typical Characteristics (continued)

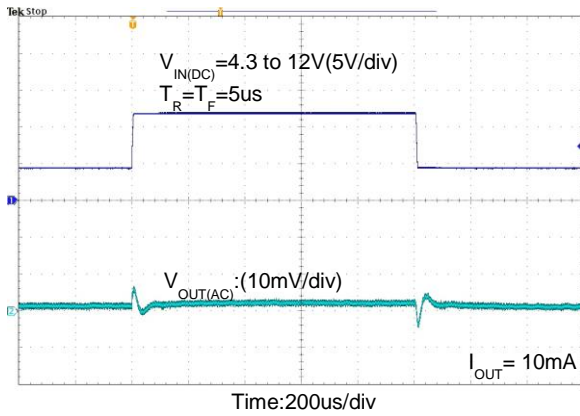

Load Transient Response
 $V_{OUT} = 3.3\text{V}$

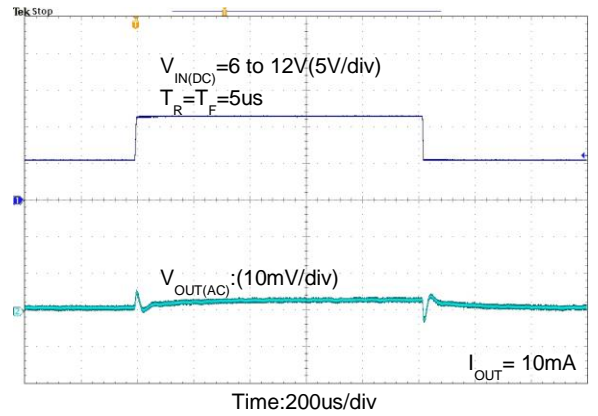

Load Transient Response
 $V_{OUT} = 3.3\text{V}$

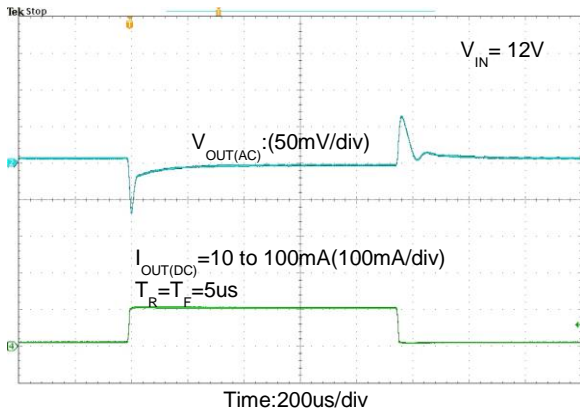

Load Transient Response
 $V_{OUT} = 5\text{V}$

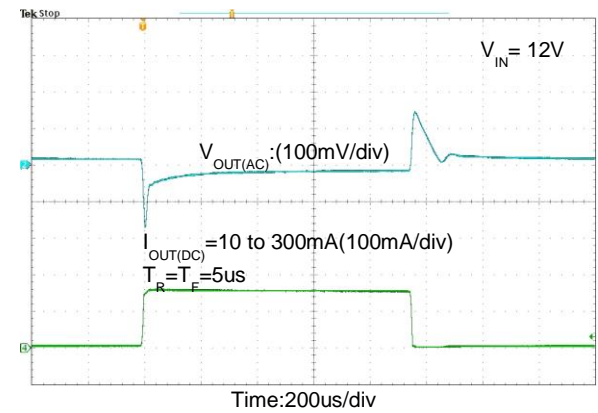

Load Transient Response
 $V_{OUT} = 5\text{V}$

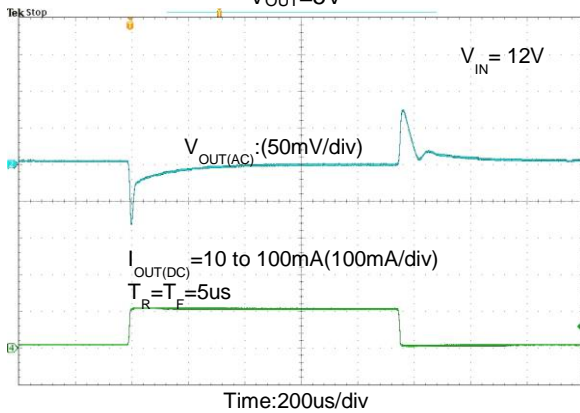

Time: 200us/div

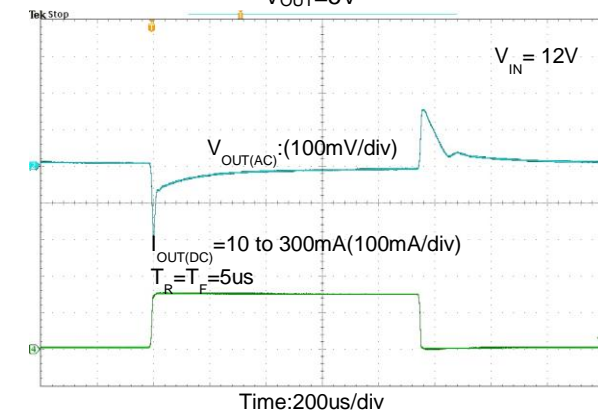

Time: 200us/div

Application Information

Output Capacitor

An output capacitor is required for the stability of the LDO. The recommended minimum output capacitance is 1 μ F. A ceramic capacitor is recommended, and temperature characteristics are X7R or X5R. Higher capacitance values help to improve load/line transient response. The output capacitance may be increased to keep low undershoot/overshoot. Place the output capacitor as close as possible to V_{OUT} and GND pins.

Input Capacitor

A 1 μ F ceramic capacitor is recommended to connect between V_{IN} and GND pins to decouple input power supply glitch and noise. The amount of the capacitance may be increased without limit. This input capacitor must be located as close as possible to the device to assure input stability and less noise. For PCB layout, a wide copper trace is required for both V_{IN} and GND.

Current-Limit and Short-Circuit Protection

When output current at V_{OUT} pin is higher than current-limit threshold or the V_{OUT} pin directly shorts to GND, current-limit protection will trigger and clamp the output current at a pre-designed level to prevent overcurrent and thermal damage.

Thermal Protection

The AP7375Q has internal thermal sense and protection circuits. When excessive power dissipation happens on the device, such as short circuit at the output pin or very heavy load current with a large voltage drop across the device, the internal thermal protection circuit will trigger, shutting down the power MOSFET to prevent the LDO from damage. As soon as the excessive thermal condition is removed and the temperature of the device drops down, the thermal protection circuit will release the control of the power MOSFET, and the LDO device returns to normal operation.

Layout Considerations

For good ground loop and stability, the input and output capacitors should be located close to the input, output, and ground pins of the device. The regulator ground pin should be connected to the external circuit ground to reduce voltage drop caused by trace impedance. Ground plane is generally used to reduce trace impedance. Wide trace should be used for large current paths from V_{IN} to V_{OUT}, and load circuit.

Ordering Information

AP7375Q - XX XXXX - XX

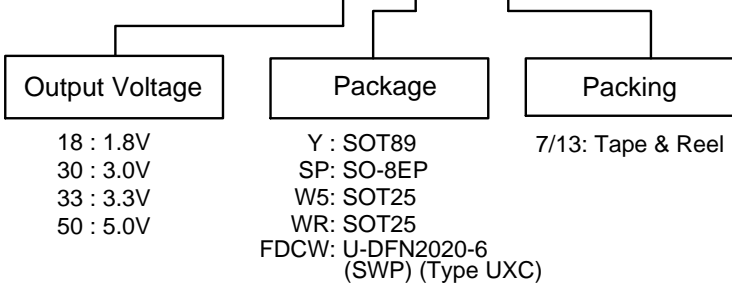

Orderable Part Number	Package Code	Package	7"/13" Tape and Reel/Ammo	
			Quantity	Part Number Suffix
AP7375Q-XXY-13	Y	SOT89	2,500/Tape & Reel	-13
AP7375Q-XXSP-13	SP	SO-8EP	2,500/Tape & Reel	-13
AP7375Q-XXW5-7	W5	SOT25	3,000/Tape & Reel	-7
AP7375Q-XXWR-7	WR	SOT25R	3,000/Tape & Reel	-7
AP7375Q-XXFDCW-7 (*)	FDCW	U-DFN2020-6 (SWP) (Type UXC)	3,000/Tape & Reel	-7

* Future Product

Marking Information

(1) SOT89

(Top View)

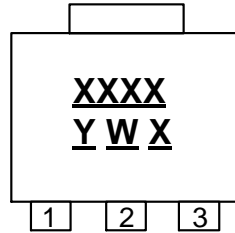

XXXX : Identification code
Y : Year : 0~9
W : Week : A~Z : 1~26 week;
a~z : 27~52 week;
z represents 52 and 53 week
X : Internal code

Orderable Part Number	Package	Identification Code
AP7375Q-18Y-13	SOT89	H5AQ
AP7375Q-30Y-13	SOT89	H5BQ
AP7375Q-33Y-13	SOT89	H5CQ
AP7375Q-50Y-13	SOT89	H5DQ

(2) SO-8EP

(Top View)

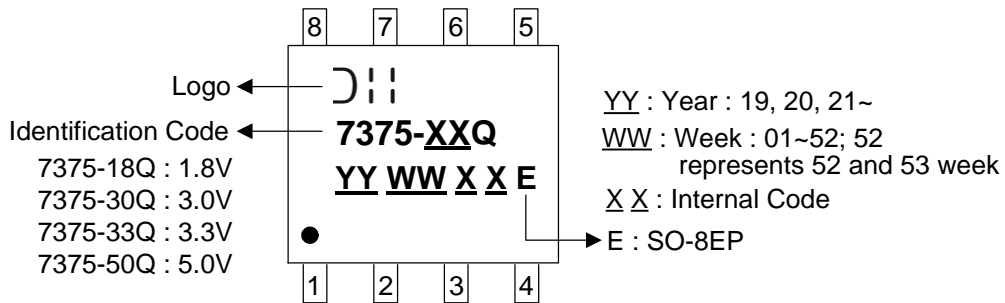

YY : Year : 19, 20, 21~
WW : Week : 01~52; 52 represents 52 and 53 week
X X : Internal Code
E : SO-8EP

Logo
Identification Code
7375-18Q : 1.8V
7375-30Q : 3.0V
7375-33Q : 3.3V
7375-50Q : 5.0V

Orderable Part Number	Package	Identification Code
AP7375Q-18SP-13	SO-8EP	7375-18Q
AP7375Q-30SP-13	SO-8EP	7375-30Q
AP7375Q-33SP-13	SO-8EP	7375-33Q
AP7375Q-50SP-13	SO-8EP	7375-50Q

Marking Information (continued)

(3) SOT25

(Top View)

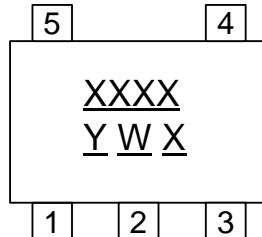

XXXX : Identification Code
Y : Year 0 to 9
W : Week : A to Z : 1 to 26 week;
a to z : 27 to 52 week; z represents
52 and 53 week
X : Internal Code

Orderable Part Number	Package	Identification Code
AP7375Q-18W5-7	SOT25	H5EQ
AP7375Q-30W5-7	SOT25	H5FQ
AP7375Q-33W5-7	SOT25	H5GQ
AP7375Q-50W5-7	SOT25	H5HQ

(4) SOT25R

(Top View)

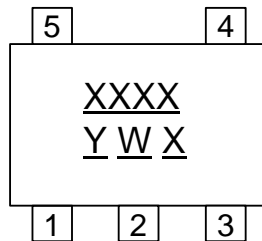

XXXX : Identification Code
Y : Year 0 to 9
W : Week : A to Z : 1 to 26 week;
a to z : 27 to 52 week; z represents
52 and 53 week
X : Internal Code

Orderable Part Number	Package	Identification Code
AP7375Q-18WR-7	SOT25R	H5AQ
AP7375Q-30WR-7	SOT25R	H5BQ
AP7375Q-33WR-7	SOT25R	H5CQ
AP7375Q-50WR-7	SOT25R	H5DQ

Marking Information (continued)

(5) U-DFN2020-6 (SWP) (Type UXC)

(Top View)

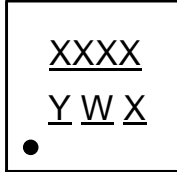

XXXX : Identification Code
Y : Year : 0~9
W : Week : A~Z : 1~26 week;
a~z : 27~52 week; z represents
52 and 53 week
X : Internal Code

Orderable Part Number	Package	Identification Code
AP7375Q-18FDCW-7	U-DFN2020-6 (SWP) (Type UXC)	H5EQ
AP7375Q-30FDCW-7	U-DFN2020-6 (SWP) (Type UXC)	H5FQ
AP7375Q-33FDCW-7	U-DFN2020-6 (SWP) (Type UXC)	H5GQ
AP7375Q-50FDCW-7	U-DFN2020-6 (SWP) (Type UXC)	H5HQ

Package Outline Dimensions (All dimensions in mm.)

(1) SOT89

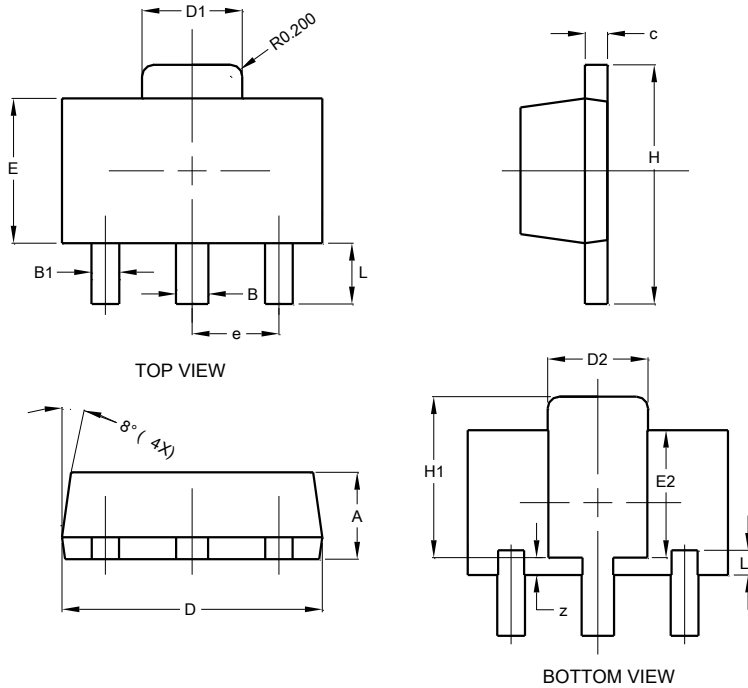

SOT89			
Dim	Min	Max	Typ
A	1.40	1.60	1.50
B	0.50	0.62	0.56
B1	0.42	0.54	0.48
c	0.35	0.43	0.38
D	4.40	4.60	4.50
D1	1.62	1.83	1.733
D2	1.61	1.81	1.71
E	2.40	2.60	2.50
E2	2.05	2.35	2.20
e	-	-	1.50
H	3.95	4.25	4.10
H1	2.63	2.93	2.78
L	0.90	1.20	1.05
L1	0.327	0.527	0.427
z	0.20	0.40	0.30
All Dimensions in mm			

(2) Package Type: SO-8EP

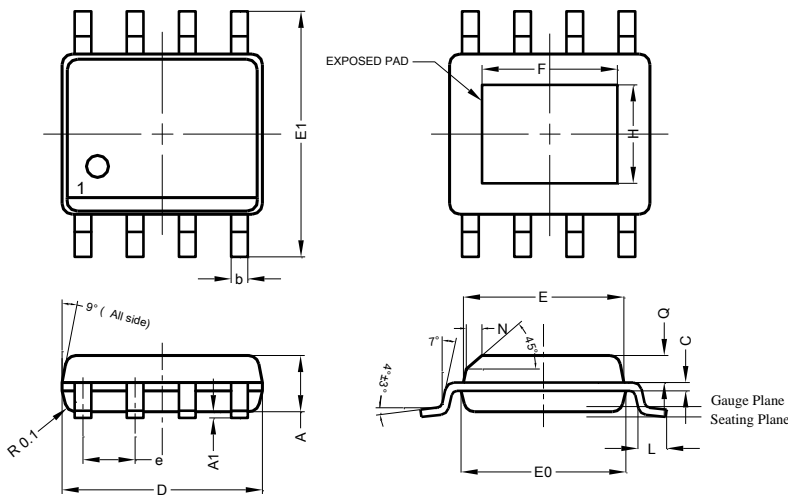

SO-8EP			
Dim	Min	Max	Typ
A	1.40	1.50	1.45
A1	0.00	0.13	-
b	0.30	0.50	0.40
C	0.15	0.25	0.20
D	4.85	4.95	4.90
E	3.80	3.90	3.85
E0	3.85	3.95	3.90
E1	5.90	6.10	6.00
e	-	-	1.27
F	2.75	3.35	3.05
H	2.11	2.71	2.41
L	0.62	0.82	0.72
N	-	-	0.35
Q	0.60	0.70	0.65
All Dimensions in mm			

Package Outline Dimensions (All dimensions in mm.) (continued)

(3) Package Type: SOT25

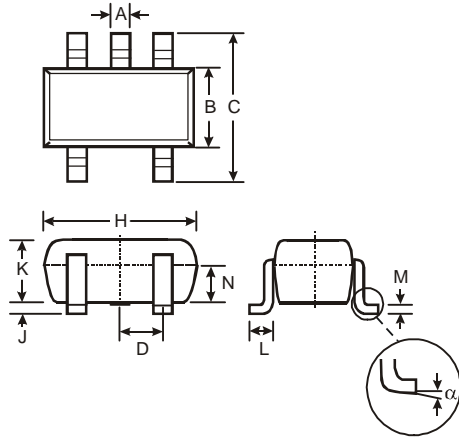

SOT25			
Dim	Min	Max	Typ
A	0.35	0.50	0.38
B	1.50	1.70	1.60
C	2.70	3.00	2.80
D	-	-	0.95
H	2.90	3.10	3.00
J	0.013	0.10	0.05
K	1.00	1.30	1.10
L	0.35	0.55	0.40
M	0.10	0.20	0.15
N	0.70	0.80	0.75
α	0°	8°	-
All Dimensions in mm			

(4) U-DFN2020-6 (SWP) (Type UXC)

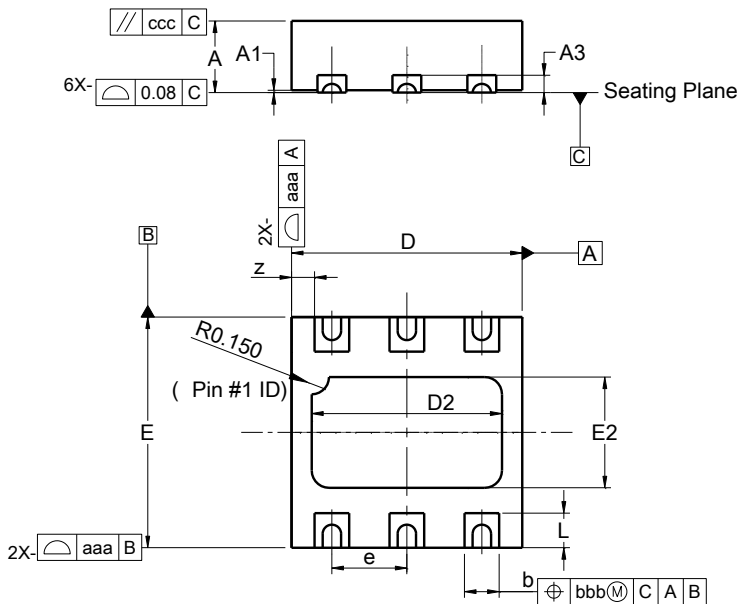

U-DFN2020-6 (SWP) (Type UXC)			
Dim	Min	Max	Typ
A	0.57	0.63	0.60
A1	0.00	0.05	0.02
A3	—	—	0.13
b	0.25	0.35	0.30
D	1.95	2.075	2.00
D2	1.55	1.75	1.65
E	1.95	2.075	2.00
E2	0.86	1.06	0.96
e	—	—	0.65
L	0.25	0.35	0.30
z	—	—	0.20
aaa	0.25		
bbb	0.10		
ccc	0.10		
All Dimensions in mm			

Suggested Pad Layout

(1) SOT89

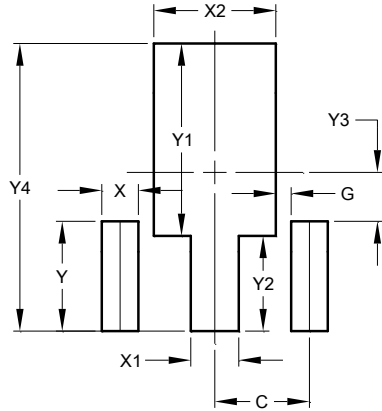

Dimensions	Value (in mm)
C	1.500
G	0.244
X	0.580
X1	0.760
X2	1.933
Y	1.730
Y1	3.030
Y2	1.500
Y3	0.770
Y4	4.530

(2) Package Type: SO-8EP

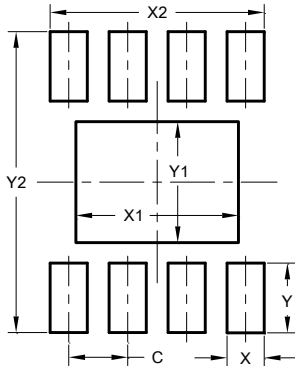

Dimensions	Value (in mm)
C	1.270
X	0.802
X1	3.502
X2	4.612
Y	1.505
Y1	2.613
Y2	6.500

Suggested Pad Layout (continued)

(3) SOT25

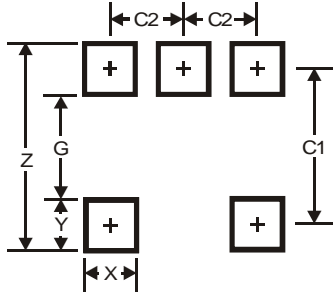

Dimensions	Value (in mm)
Z	3.20
G	1.60
X	0.55
Y	0.80
C1	2.40
C2	0.95

(4) U-DFN2020-6 (SWP) (Type UXC)

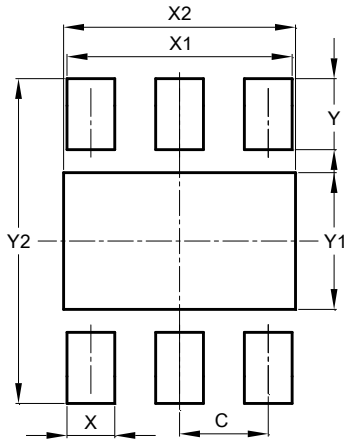

Dimensions	Value (in mm)
C	0.650
X	0.350
X1	1.650
X2	1.700
Y	0.525
Y1	1.010
Y2	2.400

Mechanical Data

- Moisture Sensitivity: Level 1 Per J-STD-020
- Terminals:
 - SOT89/ SO-8EP/ SOT25: Finish - Matte Tin Plated Leads, Solderable per MIL-STD-202, Method 208 [Ⓔ]
 - U-DFN2020-6 (SWP) (Type UXC): Finish -NiPdAu over Copper Leads, Solderable per MIL-STD-202, Method 208 [Ⓔ]
- Weight:
 - SOT89: 0.054 grams (Approximate)
 - SO-8EP: 0.075 grams (Approximate)
 - SOT25: 0.018 grams (Approximate)
 - U-DFN2020-6 (SWP) (Type UXC): 0.007 grams (Approximate)

IMPORTANT NOTICE

1. DIODES INCORPORATED (Diodes) AND ITS SUBSIDIARIES MAKE NO WARRANTY OF ANY KIND, EXPRESS OR IMPLIED, WITH REGARDS TO ANY INFORMATION CONTAINED IN THIS DOCUMENT, INCLUDING, BUT NOT LIMITED TO, THE IMPLIED WARRANTIES OF MERCHANTABILITY, FITNESS FOR A PARTICULAR PURPOSE OR NON-INFRINGEMENT OF THIRD PARTY INTELLECTUAL PROPERTY RIGHTS (AND THEIR EQUIVALENTS UNDER THE LAWS OF ANY JURISDICTION).
2. The Information contained herein is for informational purpose only and is provided only to illustrate the operation of Diodes' products described herein and application examples. Diodes does not assume any liability arising out of the application or use of this document or any product described herein. This document is intended for skilled and technically trained engineering customers and users who design with Diodes' products. Diodes' products may be used to facilitate safety-related applications; however, in all instances customers and users are responsible for (a) selecting the appropriate Diodes products for their applications, (b) evaluating the suitability of Diodes' products for their intended applications, (c) ensuring their applications, which incorporate Diodes' products, comply the applicable legal and regulatory requirements as well as safety and functional-safety related standards, and (d) ensuring they design with appropriate safeguards (including testing, validation, quality control techniques, redundancy, malfunction prevention, and appropriate treatment for aging degradation) to minimize the risks associated with their applications.
3. Diodes assumes no liability for any application-related information, support, assistance or feedback that may be provided by Diodes from time to time. Any customer or user of this document or products described herein will assume all risks and liabilities associated with such use, and will hold Diodes and all companies whose products are represented herein or on Diodes' websites, harmless against all damages and liabilities.
4. Products described herein may be covered by one or more United States, international or foreign patents and pending patent applications. Product names and markings noted herein may also be covered by one or more United States, international or foreign trademarks and trademark applications. Diodes does not convey any license under any of its intellectual property rights or the rights of any third parties (including third parties whose products and services may be described in this document or on Diodes' website) under this document.
5. Diodes' products are provided subject to Diodes' Standard Terms and Conditions of Sale (<https://www.diodes.com/about/company/terms-and-conditions/terms-and-conditions-of-sales/>) or other applicable terms. This document does not alter or expand the applicable warranties provided by Diodes. Diodes does not warrant or accept any liability whatsoever in respect of any products purchased through unauthorized sales channel.
6. Diodes' products and technology may not be used for or incorporated into any products or systems whose manufacture, use or sale is prohibited under any applicable laws and regulations. Should customers or users use Diodes' products in contravention of any applicable laws or regulations, or for any unintended or unauthorized application, customers and users will (a) be solely responsible for any damages, losses or penalties arising in connection therewith or as a result thereof, and (b) indemnify and hold Diodes and its representatives and agents harmless against any and all claims, damages, expenses, and attorney fees arising out of, directly or indirectly, any claim relating to any noncompliance with the applicable laws and regulations, as well as any unintended or unauthorized application.
7. While efforts have been made to ensure the information contained in this document is accurate, complete and current, it may contain technical inaccuracies, omissions and typographical errors. Diodes does not warrant that information contained in this document is error-free and Diodes is under no obligation to update or otherwise correct this information. Notwithstanding the foregoing, Diodes reserves the right to make modifications, enhancements, improvements, corrections or other changes without further notice to this document and any product described herein. This document is written in English but may be translated into multiple languages for reference. Only the English version of this document is the final and determinative format released by Diodes.
8. Any unauthorized copying, modification, distribution, transmission, display or other use of this document (or any portion hereof) is prohibited. Diodes assumes no responsibility for any losses incurred by the customers or users or any third parties arising from any such unauthorized use.
9. This Notice may be periodically updated with the most recent version available at <https://www.diodes.com/about/company/terms-and-conditions/important-notice>

The Diodes logo is a registered trademark of Diodes Incorporated in the United States and other countries.
All other trademarks are the property of their respective owners.
© 2023 Diodes Incorporated. All Rights Reserved.

www.diodes.com