

RSC Series

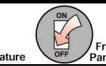

ROCKER

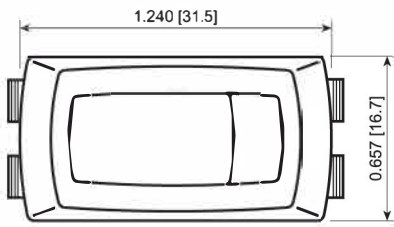

Panel Cutout

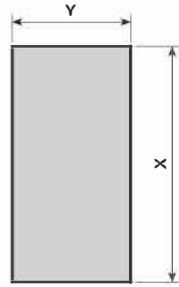

| | X | Y |
|-------------|--------------|--------------|
| RSC1-Series | 1.126 [28.6] | 0.547 [13.9] |
| RSC2-Series | 1.071 [27.2] | 0.476 [12.1] |
| RSC3-Series | 1.071 [27.2] | 0.547 [13.9] |
| RSC4-Series | 1.126 [28.6] | 0.476 [12.1] |

Actuator Options



Bi-Color



Flat

Illumination Options

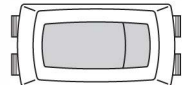

Full

Terminal Options

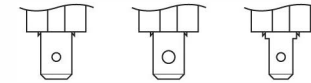

6.3mm Tab (Small Hole) 6.3mm Tab (Large Hole) 4.8mm Tab

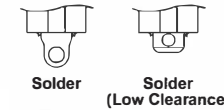

Solder Solder (Low Clearance)

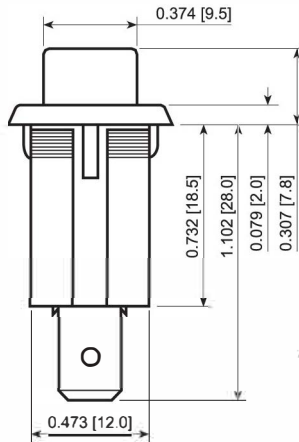
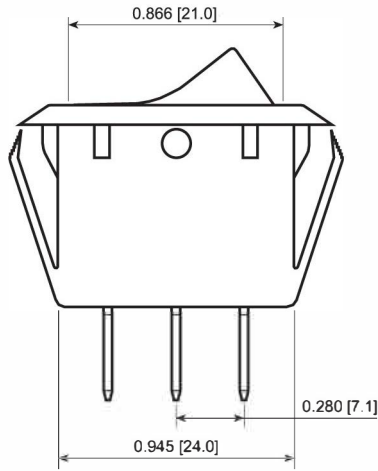

FEATURES:

- Excellent Quality and Reliability
- 4 Bodies to Cover Many Popular Cutouts
- High Current Capacity
- Illuminated and Bi-Color Actuators

SPECIFICATIONS:

RATING: RATING OPTION D:

- 20A 125VAC [UL, CSA]
- 16A 250VAC [UL, CSA]
- 1/4HP 125VAC [UL]
- 3/4HP 250VAC [UL]

RATING OPTION C:

- 15A 125VAC [UL, CSA]

TEMPERATURE: -20°C to 65°C [UL, CSA]
-20°C to 105°C [UL, CSA]

ELECTRICAL LIFE: 10,000 Cycles
CONTACT RESISTANCE: 20mΩ Max. at 1A 5VDC
INSULATION RESISTANCE: 100MΩ Min. at 500VDC
DIELECTRIC STRENGTH: 1,000VAC for 1 Minute



RSC241D125Z11

RSC141D1A24

RSC341D1123

RSC241D2200

RSC141D1021-116

| Series | Terminal | Function | Rating | Body Color | Actuator Color | Marking Color | Marking Type | Lens Style | Lens Color | Lamp Voltage |
|---------------------------|----------------------------|--------------------------|--------------------------|--------------------------|--------------------------|--------------------------|--------------------------|--------------------------|--------------------------|--------------------------|
| <input type="checkbox"/> | <input type="checkbox"/> | <input type="checkbox"/> | <input type="checkbox"/> | <input type="checkbox"/> | <input type="checkbox"/> | <input type="checkbox"/> | <input type="checkbox"/> | <input type="checkbox"/> | <input type="checkbox"/> | <input type="checkbox"/> |
| Curved Actuators: | 1 - 4.8mm Tab | 1 - Off-On (*) | C - 15A 125V | 1 - Black | 0 - Full Illum. | 0 - None | 0 - None | 1 - Full | 0 - Clear | 3 - 6V |
| RSC1 - 28.6 x 13.9 Cutout | 4 - 6.3mm Tab (Small Hole) | 3 - On-On | D - 20A 125V | 2 - White | 1 - Black | 1 - Black | 1 - I/O Vert. | 1 - Red | 1 - Red | 4 - 12V |
| RSC2 - 27.2 x 12.1 Cutout | 4 - Off-(On) | 4 - Off-(On) | | 3 - Almond | 2 - White | 2 - White | 2 - ON/OFF/ON Vert. | 2 - Amber | 2 - Amber | 5 - 24V |
| RSC3 - 27.2 x 13.9 Cutout | 5 - Solder | 5 - On-Off-On | | 4 - Grey | 3 - Almond | 3 - Almond | 3 - ON/OFF Vert. | 3 - Green | 3 - Green | 6 - 125V |
| RSC4 - 28.6 x 12.1 Cutout | 9 - 6.3mm Tab (Large Hole) | A - On-(Off) | | 9 - Red | 4 - Grey | 4 - Grey | 4 - ON/OFF Horiz. | 4 - Blue | 4 - Blue | 7 - 250V |
| | C - Solder (Low Clearance) | B - On-(On) | | | 5 - Orange | 5 - Orange | 5 - I/O Horiz. | | | |
| | | C - On-Off-(On) | | | 7 - Blue | 7 - Blue | R - I/O Horiz. | | | |
| | | | | | 8 - Green | 8 - Green | S - I/O Vert. | | | |
| | | | | | 9 - Red | 9 - Red | | | | |

Note:
* = Option Available with Illumination

Bi-Color:
A - Black / Red
B - Black / White
C - White / Red

Custom Colors and Markings Available Upon Request For Illuminated Switches Only

EXAMPLE PART NUMBERS:

- RSC141D1000-126 1P Off-On Black Body, Amber Illum. Actuator, 125V
- RSC141D1100 1P Off-On Black Body/Actuator, No Marking
- RSC141D1121 1P Off-On Black Body/Actuator, I/O Vert.
- RSC141D2200 1P Off-On White Body/Actuator, No Marking



E-SWITCH®

www.e-switch.com

800.867.2717

SPECIFICATIONS SUBJECT TO CHANGE WITHOUT NOTICE 11.16.2021