

10A, 20V - 150V Schottky Barrier Surface Mount Rectifier

FEATURES

- AEC-Q101 qualified
- Low power loss, high efficiency
- Ideal for automated placement
- Guard ring for overvoltage protection
- High surge current capability
- Moisture sensitivity level: level 1, per J-STD-020
- RoHS Compliant
- Halogen-free according to IEC 61249-2-21

APPLICATIONS

- Low voltage, high freq. inverter
- DC/DC converter
- Freewheeling diodes
- Reverse battery protection
- Car lighting

MECHANICAL DATA

- Case: TO-263AB (D²PAK)
- Molding compound meets UL 94V-0 flammability rating
- Terminal: Matte tin plated leads, solderable per J-STD-002
- Meet JESD 201 class 2 whisker test
- Polarity: As marked
- Weight: 1.37g (approximately)

KEY PARAMETERS		
PARAMETER	VALUE	UNIT
I_F	10	A
V_{RRM}	20 - 150	V
I_{FSM}	120	A
T_{JMAX}	125, 150	°C
Package	TO-263AB (D ² PAK)	
Configuration	Dual dies	

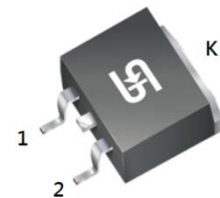
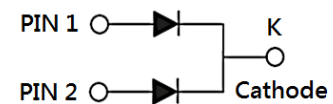
TO-263AB (D²PAK)

ABSOLUTE MAXIMUM RATINGS ($T_A = 25^\circ\text{C}$ unless otherwise noted)										
PARAMETER	SYMBOL	SRS	SRS	SRS	SRS	SRS	SRS	SRS	SRS	UNIT
		1020 H	1030 H	1040 H	1050 H	1060 H	1090 H	10100 H	10150 H	
Marking code on the device		SRS 1020	SRS 1030	SRS 1040	SRS 1050	SRS 1060	SRS 1090	SRS 10100	SRS 10150	
Repetitive peak reverse voltage	V_{RRM}	20	30	40	50	60	90	100	150	V
Reverse voltage, total rms value	$V_{R(RMS)}$	14	21	28	35	42	63	70	105	V
Forward current	I_F	10								A
Surge peak forward current, 8.3ms single half sine wave superimposed on rated load	I_{FSM}	120								A
Junction temperature	T_J	-55 to +125				-55 to +150				°C
Storage temperature	T_{STG}	-55 to +150								°C

THERMAL PERFORMANCE			
PARAMETER	SYMBOL	TYP	UNIT
Junction-to-case thermal resistance	$R_{\theta JC}$	2	°C/W

ELECTRICAL SPECIFICATIONS ($T_A = 25^\circ\text{C}$ unless otherwise noted)						
PARAMETER		CONDITIONS	SYMBOL	TYP	MAX	UNIT
Forward voltage per diode ⁽¹⁾	SRS1020H SRS1030H SRS1040H	$I_F = 5\text{A}, T_J = 25^\circ\text{C}$	V_F	-	0.55	V
	SRS1050H SRS1060H			-	0.70	V
	SRS1090H SRS10100H			-	0.90	V
	SRS10150H			-	1.00	V
Reverse current @ rated V_R per diode ⁽²⁾	SRS1020H SRS1030H SRS1040H SRS1050H SRS1060H	$T_J = 25^\circ\text{C}$	I_R	-	500	μA
	SRS1090H SRS10100H SRS10150H	$T_J = 100^\circ\text{C}$		-	100	μA
	SRS1020H SRS1030H SRS1040H			-	15	mA
	SRS1050H SRS1060H			-	10	mA
	SRS1090H SRS10100H SRS10150H	$T_J = 125^\circ\text{C}$		-	-	mA
	SRS1020H SRS1030H SRS1040H SRS1050H SRS1060H			-	-	mA
	SRS1090H SRS10100H SRS10150H			-	5	mA

Notes:

1. Pulse test with $PW = 0.3\text{ms}$
2. Pulse test with $PW = 30\text{ms}$

ORDERING INFORMATION		
ORDERING CODE⁽¹⁾	PACKAGE	PACKING
SRS10xH	TO-263AB (D ² PAK)	800 / Tape & Reel

Notes:

1. "x" defines voltage from 20V(SRS1020H) to 150V(SRS10150H)

CHARACTERISTICS CURVES

($T_A = 25^\circ\text{C}$ unless otherwise noted)

Fig.1 Forward Current Derating Curve

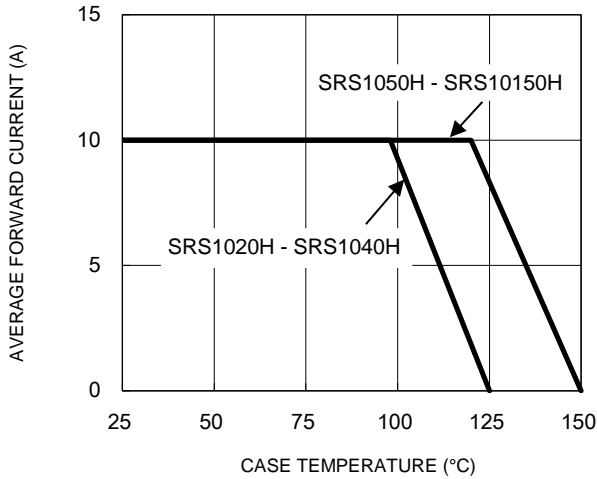

Fig.2 Typical Junction Capacitance

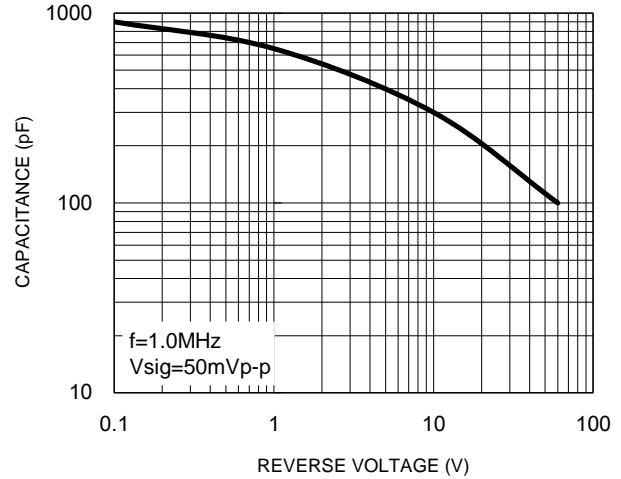

Fig.3 Typical Reverse Characteristics

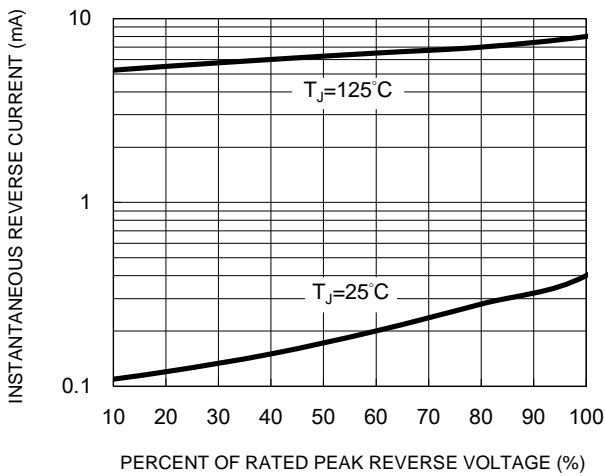

Fig.4 Typical Forward Characteristics

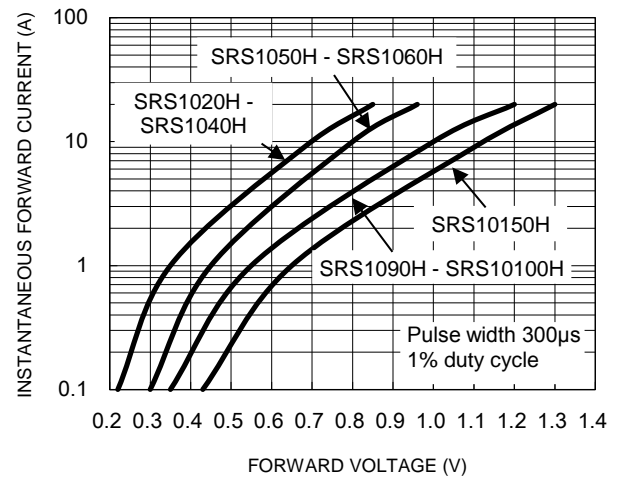
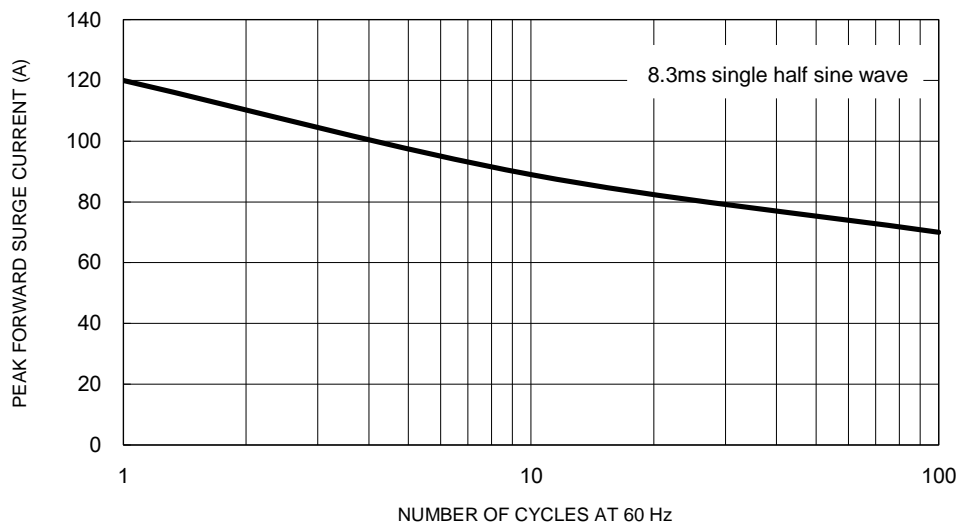

Fig.5 Maximum Non-Repetitive Forward Surge Current



CHARACTERISTICS CURVES

($T_A = 25^\circ\text{C}$ unless otherwise noted)

Fig.6 Typical Transient Thermal Impedance

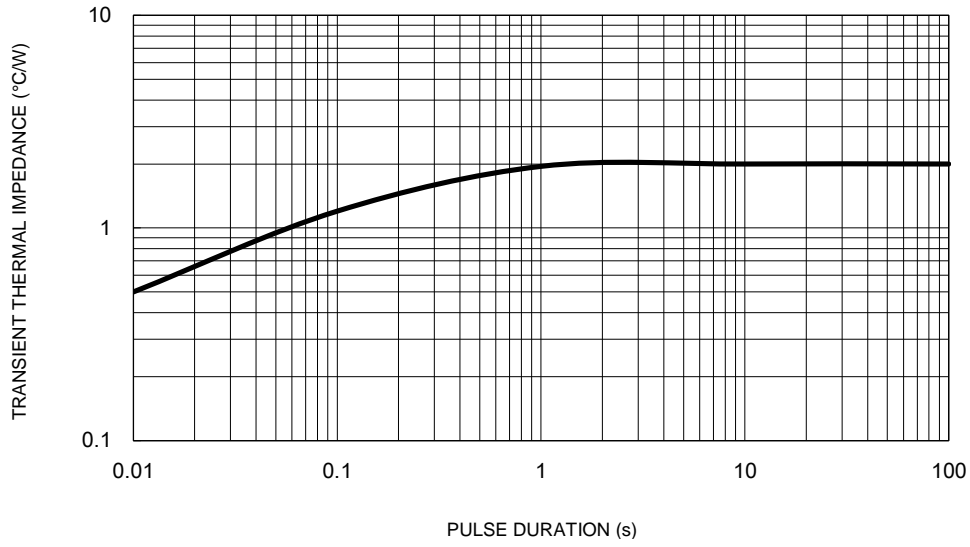

PACKAGE OUTLINE DIMENSIONS

TO-263AB (D²PAK)

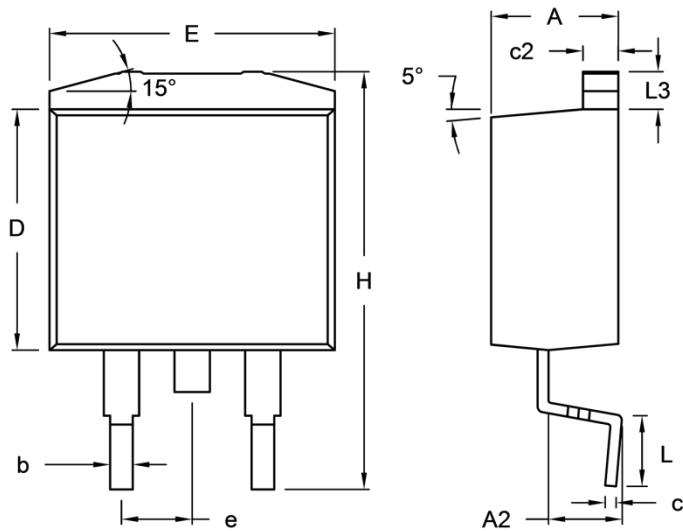

DIM.	Unit (mm)		Unit (inch)	
	Min.	Max.	Min.	Max.
A	4.44	4.70	0.175	0.185
A2	2.03	2.79	0.080	0.110
b	0.68	0.94	0.027	0.037
c	0.36	0.53	0.014	0.021
c2	1.14	1.40	0.045	0.055
D	8.25	9.25	0.325	0.364
E	-	10.50	-	0.413
e	2.41	2.67	0.095	0.105
H	14.60	15.88	0.575	0.625
L	2.29	2.79	0.090	0.110
L3	1.14	1.40	0.045	0.055

SUGGESTED PAD LAYOUT

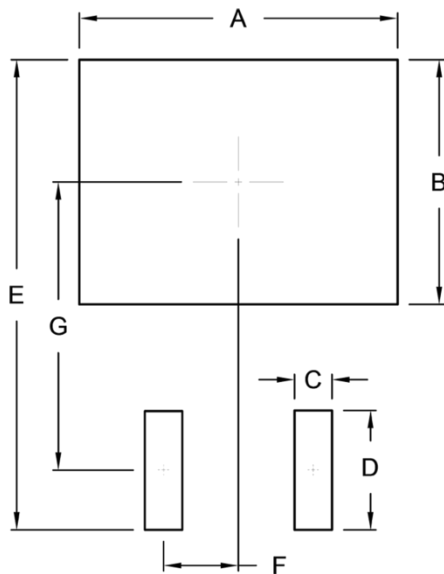

Symbol	Unit (mm)	Unit (inch)
A	10.80	0.425
B	8.30	0.327
C	1.27	0.050
D	4.05	0.159
E	15.95	0.628
F	2.54	0.100
G	9.775	0.385

MARKING DIAGRAM



- P/N = Marking Code
- G = Green Compound
- YWW = Date Code
- F = Factory Code

Notice

Specifications of the products displayed herein are subject to change without notice. TSC or anyone on its behalf assumes no responsibility or liability for any errors or inaccuracies.

Purchasers are solely responsible for the choice, selection, and use of TSC products and TSC assumes no liability for application assistance or the design of Purchasers' products.

Information contained herein is intended to provide a product description only. No license, express or implied, to any intellectual property rights is granted by this document. Except as provided in TSC's terms and conditions of sale for such products, TSC assumes no liability whatsoever, and disclaims any express or implied warranty, relating to sale and/or use of TSC products including liability or warranties relating to fitness for a particular purpose, merchantability, or infringement of any patent, copyright, or other intellectual property right.

The products shown herein are not designed for use in medical, life-saving, or life-sustaining applications. Customers using or selling these products for use in such applications do so at their own risk and agree to fully indemnify TSC for any damages resulting from such improper use or sale.