

100MHz Current Feedback Video Amplifier With Disable

November 1996

Features

- Wide Unity Gain Bandwidth 100MHz
- Slew Rate 800V/ μ s
- Output Current ± 30 mA (Min)
- Drives 3.5V into 75 Ω
- Differential Gain 0.03%
- Differential Phase 0.03 Degrees
- Low Input Voltage Noise 4.5nV/ $\sqrt{\text{Hz}}$
- Low Supply Current 10mA (Max)
- Wide Supply Range ± 5 V to ± 15 V
- Output Enable/Disable
- High Performance Replacement for EL2020

Applications

- Unity Gain Video/Wideband Buffer
- Video Gain Block
- Video Distribution Amp/Coax Cable Driver
- Flash A/D Driver
- Waveform Generator Output Driver
- Current to Voltage Converter; D/A Output Buffer
- Radar Systems
- Imaging Systems

Ordering Information

PART NUMBER (BRAND)	TEMP. RANGE (°C)	PACKAGE	PKG. NO.
HA3-5020-5	0 to 75	8 Ld PDIP	E8.3
HA7-5020-5	0 to 75	8 Ld CERDIP	F8.3A
HA9P5020-5 (H50205)	0 to 75	8 Ld SOIC	M8.15
HA3-5020-9	-40 to 85	8 Ld PDIP	E8.3
HA7-5020-9	-40 to 85	8 Ld CERDIP	F8.3A

Description

The HA-5020 is a wide bandwidth, high slew rate amplifier optimized for video applications and gains between 1 and 10. Manufactured on Harris' Reduced Feature Complementary Bipolar DI process, this amplifier uses current mode feedback to maintain higher bandwidth at a given gain than conventional voltage feedback amplifiers. Since it is a closed loop device, the HA-5020 offers better gain accuracy and lower distortion than open loop buffers.

The HA-5020 features low differential gain and phase and will drive two double terminated 75 Ω coax cables to video levels with low distortion. Adding a gain flatness performance of 0.1dB makes this amplifier ideal for demanding video applications. The bandwidth and slew rate of the HA-5020 are relatively independent of closed loop gain. The 100MHz unity gain bandwidth only decreases to 60MHz at a gain of 10. The HA-5020 used in place of a conventional op amp will yield a significant improvement in the speed power product. To further reduce power, the HA-5020 has a disable function which significantly reduces supply current, while forcing the output to a true high impedance state. This allows the outputs of multiple amplifiers to be wire-OR'd into multiplexer configurations. The device also includes output short circuit protection and output offset voltage adjustment.

The HA-5020 is available in commercial and industrial temperature ranges, and a choice of packages. See the "Ordering Information" section below for more information. For military grade product, please refer to the HA-5020/883 datasheet.

For multi channel versions of the HA-5020 see the HA5022 dual with disable, HA5023 dual, HA5013 triple, HA5024 quad with disable or HA5025 quad op amp data sheets.

Pinout

HA-5020
(PDIP, CERDIP, SOIC)
TOP VIEW

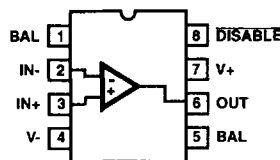

HA-5020

Absolute Maximum Ratings (Note 1)

Voltage Between V+ and V- Terminals	36V
DC Input Voltage	$\pm V_{SUPPLY}$
Differential Input Voltage	10V
Output Current	Short Circuit Protected

Operating Conditions

Temperature Range	
HA-5020-5	0°C to 75°C
HA-5020-9	-40°C to 85°C

Thermal Information

Thermal Resistance (Typical, Note 2)	θ_{JA} (°C/W)	θ_{JC} (°C/W)
PDIP Package	130	N/A
CERDIP Package	135	50
SOIC Package	170	N/A
Maximum Junction Temperature (Ceramic Package, Note 1)	175°C	
Maximum Junction Temperature (Plastic Packages, Note 1)	150°C	
Maximum Storage Temperature Range	-65°C to 150°C	
Maximum Lead Temperature (Soldering 10s)	300°C (SOIC - Lead Tips Only)	

CAUTION: Stresses above those listed in "Absolute Maximum Ratings" may cause permanent damage to the device. This is a stress only rating and operation of the device at these or any other conditions above those indicated in the operational sections of this specification is not implied.

NOTES:

- Maximum power dissipation, including output load, must be designed to maintain junction temperature below 175°C for ceramic packages, and below 150°C for plastic packages.
- θ_{JA} is measured with the component mounted on an evaluation PC board in free air.

Electrical Specifications

$V_{SUPPLY} = \pm 15V$, $R_F = 1k\Omega$, $A_V = +1$, $R_L = 400\Omega$, $C_L \leq 10pF$, Unless Otherwise Specified

PARAMETER	TEST CONDITIONS	TEMP. (°C)	HA-5020-5, -9			UNITS
			MIN	TYP	MAX	
INPUT CHARACTERISTICS						
Input Offset Voltage (Notes 3, 14)		25	-	2	8	mV
		Full	-	-	10	mV
Average Input Offset Voltage Drift		Full	-	10	-	$\mu V/^\circ C$
V_{IO} Common Mode Rejection Ratio (Note 14)	$V_{CM} = \pm 10V$	25	60	-	-	dB
		Full	50	-	-	dB
V_{IO} Power Supply Rejection Ratio (Note 14)	$\pm 4.5V \leq V_S \leq \pm 18V$	25	64	-	-	dB
		Full	60	-	-	dB
Non-Inverting Input (+IN) Current (Note 14)		25	-	3	8	μA
		Full	-	-	20	μA
+IN Common Mode Rejection	$V_{CM} = \pm 10V$	25	-	-	0.1	$\mu A/V$
		Full	-	-	0.5	$\mu A/V$
+IN Power Supply Rejection	$4.5V \leq V_S \leq \pm 18V$	25	-	-	0.06	$\mu A/V$
		Full	-	-	0.2	$\mu A/V$
Inverting Input (-IN) Current (Note 14)		25	-	12	20	μA
		Full	-	25	50	μA
-IN Common Mode Rejection	$V_{CM} = \pm 10V$	25	-	-	0.4	$\mu A/V$
		Full	-	-	0.5	$\mu A/V$
-IN Power Supply Rejection	$4.5V \leq V_S \leq \pm 18V$	25	-	-	0.2	$\mu A/V$
		Full	-	-	0.5	$\mu A/V$
TRANSFER CHARACTERISTICS						
Transimpedance (Notes 9, 14)		25	3500	-	-	V/mA
		Full	1000	-	-	V/mA
Open Loop DC Voltage Gain (Note 9)	$R_L = 400\Omega$, $V_{OUT} = \pm 10V$	25	70	-	-	dB
		Full	65	-	-	dB
Open Loop DC Voltage Gain	$R_L = 100\Omega$, $V_{OUT} = \pm 2.5V$	25	60	-	-	dB
		Full	55	-	-	dB
OUTPUT CHARACTERISTICS						
Output Voltage Swing (Note 14)	$R_L = 150\Omega$	25 to 85	± 12	± 12.7	-	V
		-40 to 0	± 11	± 11.8	-	V

3

OPERATIONAL
AMPLIFIERS

HA-5020

Electrical Specifications $V_{SUPPLY} = \pm 15V$, $R_F = 1k\Omega$, $A_V = +1$, $R_L = 400\Omega$, $C_L \leq 10pF$,
Unless Otherwise Specified (Continued)

PARAMETER	TEST CONDITIONS	TEMP. (°C)	HA-5020-5, -9			UNITS
			MIN	TYP	MAX	
Output Current (Guaranteed by Output Voltage Test)		25	±30	±31.7	-	mA
		Full	±27.5	-	-	mA
POWER SUPPLY CHARACTERISTICS						
Quiescent Supply Current (Note 14)		Full	-	7.5	10	mA
Supply Current, Disabled (Note 14)	DISABLE = 0V	Full	-	5	7.5	mA
Disable Pin Input Current	DISABLE = 0V	Full	-	1.0	1.5	mA
Minimum Pin 8 Current to Disable (Note 4)		Full	350	-	-	µA
Maximum Pin 8 Current to Enable (Note 5)		Full	-	-	20	µA
AC CHARACTERISTICS (A_V = +1)						
Slew Rate (Note 6)		25	600	800	-	V/µs
		Full	500	700	-	V/µs
Full Power Bandwidth (Note 7) (Guaranteed by Slew Rate Test)		25	9.6	12.7	-	MHz
		Full	8.0	11.1	-	MHz
Rise Time (Note 8)		25	-	5	-	ns
Fall Time (Note 8)		25	-	5	-	ns
Propagation Delay (Notes 8, 14)		25	-	6	-	ns
-3dB Bandwidth (Note 14)	V _{OUT} = 100mV	25	-	100	-	MHz
Settling Time to 1%	10V Output Step	25	-	45	-	ns
Settling Time to 0.25%	10V Output Step	25	-	100	-	ns
AC CHARACTERISTICS (A_V = +10, R_F = 383Ω)						
Slew Rate (Notes 6, 9)		25	900	1100	-	V/µs
		Full	700	-	-	V/µs
Full Power Bandwidth (Note 7) (Guaranteed by Slew Rate Test)		25	14.3	17.5	-	MHz
		Full	11.1	-	-	MHz
Rise Time (Note 8)		25	-	8	-	ns
Fall Time (Note 8)		25	-	8	-	ns
Propagation Delay (Notes 8, 14)		25	-	9	-	ns
-3dB Bandwidth	V _{OUT} = 100mV	25	-	60	-	MHz
Settling Time to 1%	10V Output Step	25	-	55	-	ns
Settling Time to 0.1%	10V Output Step	25	-	90	-	ns
HARRIS VALUE ADDED SPECIFICATIONS						
Input Noise Voltage (Note 14)	f = 1kHz	25	-	4.5	-	nV/√Hz
+Input Noise Current (Note 14)	f = 1kHz	25	-	2.5	-	pA/√Hz
-Input Noise Current (Note 14)	f = 1kHz	25	-	25	-	pA/√Hz
Input Common Mode Range		Full	±10	±12	-	V
-I _{BIAS} Adjust Range (Note 3)		Full	±25	±40	-	µA
Overshoot (Note 14)		25	-	7	-	%
Output Current, Short Circuit (Note 14)	V _{IN} = ±10V, V _{OUT} = 0V	Full	±50	±65	-	mA
Output Current, Disabled (Note 14)	DISABLE = 0V, V _{OUT} = ±10V	Full	-	-	1	µA
Output Disable Time (Notes 10, 14)		25	-	10	-	µs
Output Enable Time (Notes 11, 14)		25	-	200	-	ns
Supply Voltage Range		25	±5	-	±15	V
Output Capacitance, Disabled (Note 12)	DISABLE = 0V	25	-	6	-	pF

HA-5020

Electrical Specifications $V_{SUPPLY} = \pm 15V$, $R_F = 1k\Omega$, $A_V = +1$, $R_L = 400\Omega$, $C_L \leq 10pF$,
Unless Otherwise Specified (Continued)

PARAMETER	TEST CONDITIONS	TEMP. (°C)	HA-5020-5, -9			UNITS
			MIN	TYP	MAX	
VIDEO CHARACTERISTICS						
Differential Gain (Notes 13, 14)	$R_L = 150\Omega$	25	-	0.03	-	%
Differential Phase (Notes 18, 20, 21)	$R_L = 150\Omega$	25	-	0.03	-	Degrees
Gain Flatness	To 5MHz	25	-	0.1	-	dB

Electrical Specifications $V_+ = +5V$, $V_- = -5V$, $R_F = 1k\Omega$, $A_V = +1$, $R_L = 400\Omega$, $C_L \leq 10pF$, Unless Otherwise Specified.
Parameters are not tested. The limits are guaranteed based on lab characterizations, and reflect lot-to-lot variation.

PARAMETER	TEST CONDITIONS	TEMP. (°C)	HA-5020-5, -9			UNITS
			MIN	TYP	MAX	
INPUT CHARACTERISTICS						
Input Offset Voltage (Notes 3, 14)		25	-	2	8	mV
		Full	-	-	10	mV
Average Input Offset Voltage Drift		Full	-	10	-	$\mu V/^\circ C$
V_{IO} Common Mode Rejection Ratio (Notes 14, 15)		25	50	-	-	dB
		Full	35	-	-	dB
V_{IO} Power Supply Rejection Ratio (Note 14)	$\pm 3.5V \leq V_S \leq \pm 6.5V$	25	55	-	-	dB
		Full	50	-	-	dB
Non-Inverting Input (+IN) Current (Note 14)		25	-	3	8	μA
		Full	-	-	20	μA
+IN Common Mode Rejection (Note 15)		25	-	-	0.1	$\mu A/V$
		Full	-	-	0.5	$\mu A/V$
+IN Power Supply Rejection	$\pm 3.5V \leq V_S \leq \pm 6.5V$	25	-	-	0.06	$\mu A/V$
		Full	-	-	0.2	$\mu A/V$
Inverting Input (-IN) Current (Note 14)		25	-	12	20	μA
		Full	-	25	50	μA
-IN Common Mode Rejection (Note 15)		25	-	-	0.4	$\mu A/V$
		Full	-	-	0.5	$\mu A/V$
-IN Power Supply Rejection	$\pm 3.5V \leq V_S \leq \pm 6.5V$	25	-	-	0.2	$\mu A/V$
		Full	-	-	0.5	$\mu A/V$
TRANSFER CHARACTERISTICS						
Transimpedance (Notes 9, 14)		25	1000	-	-	V/mA
		Full	850	-	-	V/mA
Open Loop DC Voltage Gain	$R_L = 400\Omega$, $V_{OUT} = \pm 2.5V$	25	65	-	-	dB
		Full	60	-	-	dB
Open Loop DC Voltage Gain	$R_L = 100\Omega$, $V_{OUT} = \pm 2.5V$	25	50	-	-	dB
		Full	45	-	-	dB
OUTPUT CHARACTERISTICS						
Output Voltage Swing (Note 14)		25 to 85	± 2.5	± 3.0	-	V
		-40 to 0	± 2.5	± 3.0	-	V

3

OPERATIONAL
AMPLIFIERS

HA-5020

Electrical Specifications $V_+ = +5V$, $V_- = -5V$, $R_F = 1k\Omega$, $A_V = +1$, $R_L = 400\Omega$, $C_L \leq 10pF$, Unless Otherwise Specified.
Parameters are not tested. The limits are guaranteed based on lab characterizations, and reflect lot-to-lot variation. (Continued)

PARAMETER	TEST CONDITIONS	TEMP. (°C)	HA-5020-5, -9			UNITS
			MIN	TYP	MAX	
Output Current (Guaranteed by Output Voltage Test)	$R_L = 100\Omega$	25	± 16.6	± 20	-	mA
		Full	± 16.6	± 20	-	mA
POWER SUPPLY CHARACTERISTICS						
Quiescent Supply Current (Note 14)		Full	-	7.5	10	mA
Supply Current, Disabled (Note 14)	DISABLE = 0V	Full	-	5	7.5	mA
Disable Pin Input Current	DISABLE = 0V	Full	-	1.0	1.5	mA
Minimum Pin 8 Current to Disable (Note 16)		Full	350	-	-	μA
Maximum Pin 8 Current to Enable (Note 5)		Full	-	-	20	μA
AC CHARACTERISTICS ($A_V = +1$)						
Slew Rate (Note 17)		25	215	400	-	V/ μs
Full Power Bandwidth (Note 18)		25	22	28	-	MHz
Rise Time (Note 8)		25	-	6	-	ns
Fall Time (Note 8)		25	-	6	-	ns
Propagation Delay (Note 8)		25	-	6	-	ns
Overshoot		25	-	4.5	-	%
-3dB Bandwidth (Note 14)	$V_{OUT} = 100mV$	25	-	125	-	MHz
Settling Time to 1%	2V Output Step	25	-	50	-	ns
Settling Time to 0.25%	2V Output Step	25	-	75	-	ns
AC CHARACTERISTICS ($A_V = +2$, $R_F = 681\Omega$)						
Slew Rate (Note 17)		25	-	475	-	V/ μs
Full Power Bandwidth (Note 18)		25	-	26	-	MHz
Rise Time (Note 8)		25	-	6	-	ns
Fall Time (Note 8)		25	-	6	-	ns
Propagation Delay (Note 8)		25	-	6	-	ns
Overshoot		25	-	12	-	%
-3dB Bandwidth (Note 14)	$V_{OUT} = 100mV$	25	-	95	-	MHz
Settling Time to 1%	2V Output Step	25	-	50	-	ns
Settling Time to 0.25%	2V Output Step	25	-	100	-	ns
AC CHARACTERISTICS ($A_V = +10$, $R_F = 383\Omega$)						
Slew Rate (Note 17)		25	350	475	-	V/ μs
Full Power Bandwidth (Note 18)		25	28	38	-	MHz
Rise Time (Note 8)		25	-	8	-	ns
Fall Time (Note 8)		25	-	9	-	ns
Propagation Delay (Note 8)		25	-	9	-	ns
Overshoot		25	-	1.8	-	%
-3dB Bandwidth (Note 14)	$V_{OUT} = 100mV$	25	-	65	-	MHz
Settling Time to 1%	2V Output Step	25	-	75	-	ns

HA-5020

Electrical Specifications $V_+ = +5V, V_- = -5V, R_F = 1k\Omega, A_V = +1, R_L = 400\Omega, C_L \leq 10pF$, Unless Otherwise Specified. Parameters are not tested. The limits are guaranteed based on lab characterizations, and reflect lot-to-lot variation. (Continued)

PARAMETER	TEST CONDITIONS	TEMP. (°C)	HA-5020-5, -9			UNITS
			MIN	TYP	MAX	
Settling Time to 0.25%	2V Output Step	25	-	130	-	ns
HARRIS VALUE ADDED SPECIFICATIONS						
Input Noise Voltage (Note 14)	$f = 1kHz$	25	-	4.5	-	nV/\sqrt{Hz}
+Input Noise Current (Note 14)	$f = 1kHz$	25	-	2.5	-	pA/\sqrt{Hz}
-Input Noise Current (Note 14)	$f = 1kHz$	25	-	25	-	pA/\sqrt{Hz}
Input Common Mode Range		Full	$\pm 2.5V$	-	-	V
Output Current, Short Circuit	$V_{IN} = \pm 2.5V, V_{OUT} = 0V$	Full	± 40	± 60	-	mA
Output Current, Disabled (Note 14)	$DISABLE = 0V, V_{OUT} = \pm 2.5V, V_{IN} = 0V$	Full	-	-	2	μA
Output Disable Time (Notes 14, 20)		25	-	40	-	μs
Output Enable Time (Notes 14, 21)		25	-	40	-	ns
Supply Voltage Range		25	± 5	-	± 15	V
Output Capacitance, Disabled (Note 19)	$DISABLE = 0V$	25	-	6	-	pF
VIDEO CHARACTERISTICS						
Differential Gain (Notes 13, 14)	$R_L = 150\Omega$	25	-	0.03	-	%
Differential Phase (Notes 13, 14)	$R_L = 150\Omega$	25	-	0.03	-	Degrees
Gain Flatness to 5MHz	To 5MHz	25	-	0.1	-	dB

NOTES:

- Suggested V_{OS} Adjust Circuit: The inverting input current ($-I_{BIAS}$) can be adjusted with an external 10k Ω pot between pins 1 and 5, wiper connected to V_+ . Since $-I_{BIAS}$ flows through the feedback resistor (R_F), the result is an adjustment in offset voltage. The amount of offset voltage adjustment is determined by the value of R_F ($\Delta V_{OS} = \Delta I_{BIAS} \cdot R_F$).
- $R_L = 100\Omega, V_{IN} = 10V$. This is the minimum current which must be pulled out of the $\overline{Disable}$ pin in order to disable the output. The output is considered disabled when $-10mV \leq V_{OUT} \leq +10mV$.
- $V_{IN} = 0V$. This is the maximum current that can be pulled out of the $\overline{Disable}$ pin with the HA-5020 remaining enabled. The HA-5020 is considered disabled when the supply current has decreased by at least 0.5mA.
- V_{OUT} switches from -10V to +10V, or from +10V to -10V. Specification is from the 25% to 75% points.
- $FPBW = \frac{Slew\ Rate}{2\pi V_{PEAK}}; V_{PEAK} = 10V$.
- $R_L = 100\Omega, V_{OUT} = 1V$. Measured from 10% to 90% points for rise/fall times; from 50% points of input and output for propagation delay.
- This parameter is not tested. The limits are guaranteed based on lab characterization, and reflect lot-to-lot variation.
- $V_{IN} = +10V, \overline{Disable} = +15V$ to 0V. Measured from the 50% point of $\overline{Disable}$ to $V_{OUT} = 0V$.
- $V_{IN} = +10V, \overline{Disable} = 0V$ to +15V. Measured from the 50% point of $\overline{Disable}$ to $V_{OUT} = 10V$.
- $V_{IN} = 0V$, Force V_{OUT} from 0V to $\pm 10V, t_R = t_F = 50ns$.
- Measured with a VM700A video tester using a NTC-7 composite VITS.
- See "Typical Performance Curves" for more information.
- $V_{CM} = \pm 2.5V$. At -40°C product is tested at $V_{CM} = \pm 2.5V$ because short test duration does not allow self heating.
- $R_L = 100\Omega, V_{IN} = 2.5V$. This is the minimum current which must be pulled out of the $\overline{Disable}$ pin in order to disable the output. The output is considered disabled when $-10mV \leq V_{OUT} \leq +10mV$.
- V_{OUT} switches from -2V to +2V, or from +2V to -2V. Specification is from the 25% to 75% points.
- $FPBW = \frac{Slew\ Rate}{2\pi V_{PEAK}}; V_{PEAK} = 2V$.
- $V_{IN} = 0V$. Force V_{OUT} from 0V to $\pm 2.5V, t_R = t_F = 50ns$.
- $V_{IN} = +2V, \overline{Disable} = +5V$ to 0V. Measured from the 50% point of $\overline{Disable}$ to $V_{OUT} = 0V$.
- $V_{IN} = +2V, \overline{Disable} = 0V$ to +5V. Measured from the 50% point of $\overline{Disable}$ to $V_{OUT} = 2V$.

3
OPERATIONAL AMPLIFIERS

Test Circuits and Waveforms

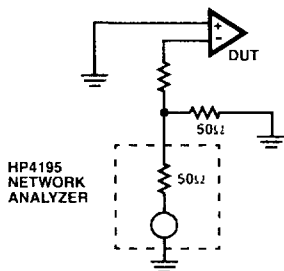

FIGURE 1. TEST CIRCUIT FOR TRANSIMPEDANCE MEASUREMENTS

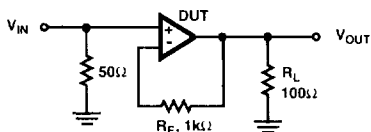

FIGURE 2. SMALL SIGNAL PULSE RESPONSE CIRCUIT

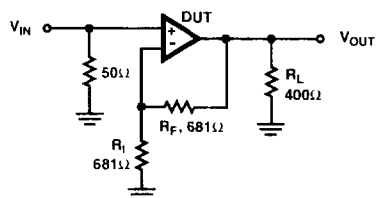
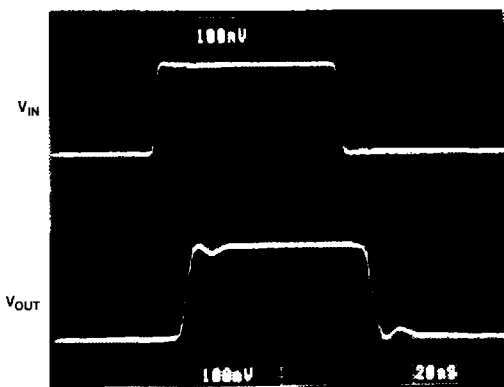
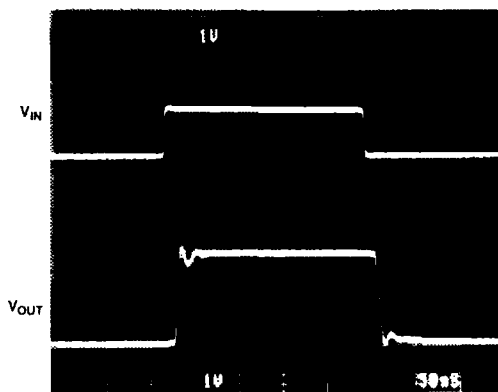

FIGURE 3. LARGE SIGNAL PULSE RESPONSE CIRCUIT



Vertical Scale: $V_{IN} = 100\text{mV/Div.}$, $V_{OUT} = 100\text{mV/Div.}$
Horizontal Scale: 20ns/Div.

FIGURE 4. SMALL SIGNAL RESPONSE



Vertical Scale: $V_{IN} = 1\text{V/Div.}$, $V_{OUT} = 1\text{V/Div.}$
Horizontal Scale: 50ns/Div.

FIGURE 5. LARGE SIGNAL RESPONSE

Schematic Diagram

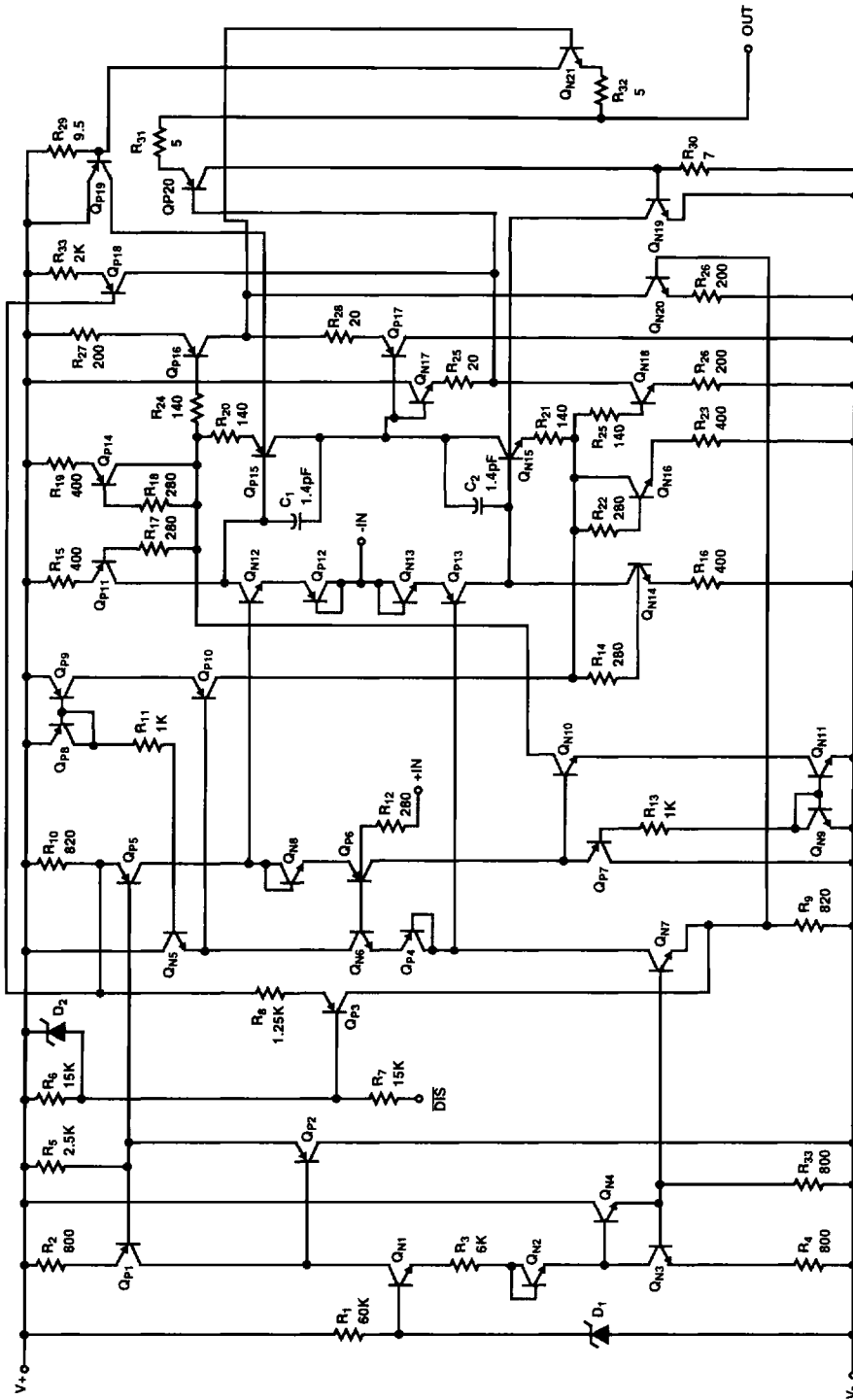

Application Information

Optimum Feedback Resistor

The plots of inverting and non-inverting frequency response illustrate the performance of the HA-5020 in various closed loop gain configurations. Although the bandwidth dependency on closed loop gain isn't as severe as that of a voltage feedback amplifier, there can be an appreciable decrease in bandwidth at higher gains. This decrease may be minimized by taking advantage of the current feedback amplifier's unique relationship between bandwidth and R_F . All current feedback amplifiers require a feedback resistor, even for unity gain applications, and R_F , in conjunction with the internal compensation capacitor, sets the dominant pole of the frequency response. Thus, the amplifier's bandwidth is inversely proportional to R_F . The HA-5020 design is optimized for a 1000Ω R_F at a gain of +1. Decreasing R_F in a unity gain application decreases stability, resulting in excessive peaking and overshoot. At higher gains the amplifier is more stable, so R_F can be decreased in a trade-off of stability for bandwidth.

The table below lists recommended R_F values for various gains, and the expected bandwidth.

GAIN (A_{CL})	R_F (Ω)	BANDWIDTH (MHz)
-1	750	100
+1	1000	125
+2	681	95
+5	1000	52
+10	383	65
-10	750	22

PC Board Layout

The frequency response of this amplifier depends greatly on the amount of care taken in designing the PC board. The use of low inductance components such as chip resistors and chip capacitors is strongly recommended. If leaded components are used the leads must be kept short especially for the power supply decoupling components and those components connected to the inverting input.

Attention must be given to decoupling the power supplies. A large value (10 μ F) tantalum or electrolytic capacitor in parallel with a small value (0.1 μ F) chip capacitor works well in most cases.

A ground plane is strongly recommended to control noise. Care must also be taken to minimize the capacitance to ground seen by the amplifier's inverting input (-IN). The larger this capacitance, the worse the gain peaking, resulting in pulse overshoot and possible instability. It is recommended that the ground plane be removed under traces connected to -IN, and that connections to -IN be kept as short as possible to minimize the capacitance from this node to ground.

Driving Capacitive Loads

Capacitive loads will degrade the amplifier's phase margin resulting in frequency response peaking and possible oscillations. In most cases the oscillation can be avoided by placing an isolation resistor (R) in series with the output as shown in Figure 6.

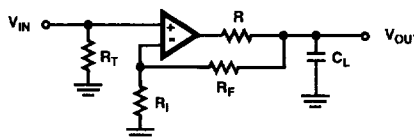

FIGURE 6. PLACEMENT OF THE OUTPUT ISOLATION RESISTOR, R

The selection criteria for the isolation resistor is highly dependent on the load, but 27Ω has been determined to be a good starting value.

Enable/Disable Function

When enabled the amplifier functions as a normal current feedback amplifier with all of the data in the electrical specifications table being valid and applicable. When disabled the amplifier output assumes a true high impedance state and the supply current is reduced significantly.

The circuit shown in Figure 7 is a simplified schematic of the enable/disable function. The large value resistors in series with the DISABLE pin makes it appear as a current source to the driver. When the driver pulls this pin low current flows out of the pin and into the driver. This current, which may be as large as 350μ A when external circuit and process variables are at their extremes, is required to insure that point "A" achieves the proper potential to disable the output. The driver must have the compliance and capability of sinking all of this current.

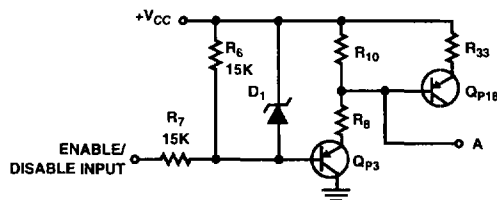

FIGURE 7. SIMPLIFIED SCHEMATIC OF ENABLE/DISABLE FUNCTION

When V_{CC} is +5V the DISABLE pin may be driven with a dedicated TTL gate. The maximum low level output voltage of the TTL gate, 0.4V, has enough compliance to insure that the amplifier will always be disabled even though D_1 will not turn on, and the TTL gate will sink enough current to keep point "A" at its proper voltage. When V_{CC} is greater than +5V the DISABLE pin should be driven with an open collector device that has a breakdown rating greater than V_{CC} .

Referring to Figure 7, it can be seen that R_6 will act as a pull-up resistor to $+V_{CC}$ if the DISABLE pin is left open. In those cases where the enable/disable function is not required on all circuits some circuits can be permanently enabled by letting the DISABLE pin float. If a driver is used to set the enable/disable level, be sure that the driver does not sink more than 20μ A when the DISABLE pin is at a high level. TTL gates, especially CMOS versions, do not violate this criteria so it is permissible to control the enable/disable function with TTL.

Typical Applications

Two Channel Video Multiplexer

Referring to the amplifier U_{1A} in Figure 8, R_1 terminates the cable in its characteristic impedance of 75Ω , and R_4 back terminates the cable in its characteristic impedance. The amplifier is set up in a gain configuration of +2 to yield an overall network gain of +1 when driving a double terminated cable. The value of R_3 can be changed if a different network gain is desired. R_5 holds the disable pin at ground thus inhibiting the amplifier until the switch, S_1 , is thrown to position 1. At position 1 the switch pulls the disable pin up to the plus supply rail thereby enabling the amplifier. Since all of the actual signal switching takes place within the amplifier, its differential gain and phase parameters, which are 0.03% and 0.03 degrees respectively, determine the circuit's performance. The other circuit, U_{1B} , operates in a similar manner.

When the plus supply rail is 5V the disable pin can be driven by a dedicated TTL gate as discussed earlier. If a multiplexer IC or its equivalent is used to select channels its logic must be break before make. When these conditions are satisfied the HA-5020 is often used as a remote video multiplexer, and the multiplexer may be extended by adding more amplifier ICs.

Low Impedance Multiplexer

Two common problems surface when you try to multiplex multiple high speed signals into a low impedance source such as an A/D converter. The first problem is the low source impedance which tends to make amplifiers oscillate and causes gain errors. The second problem is the multiplexer which supplies no gain, introduces all kinds of distortion and limits the frequency response. Using op amps which have an enable/disable function, such as the HA-5020, eliminates the

multiplexer problems because the external mux chip is not needed, and the HA-5020 can drive low impedance (large capacitance) loads if a series isolation resistor is used.

Referring to Figure 9, both inputs are terminated in their characteristic impedance; 75Ω is typical for video applications. Since the drivers usually are terminated in their characteristic impedance the input gain is 0.5, thus the amplifiers, U_2 , are configured in a gain of +2 to set the circuit gain equal to one. Resistors R_2 and R_3 determine the amplifier gain, and if a different gain is desired R_2 should be changed according to the equation $G = (1 + R_3/R_2)$. R_3 sets the frequency response of the amplifier so you should refer to the manufacturers data sheet before changing its value. R_5 , C_1 and D_1 are an asymmetrical charge/discharge time circuit which configures U_1 as a break before make switch to prevent both amplifiers from being active simultaneously. If this design is extended to more channels the drive logic must be designed to be break before make. R_4 is enclosed in the feedback loop of the amplifier so that the large open loop amplifier gain of U_2 will present the load with a small closed loop output impedance while keeping the amplifier stable for all values of load capacitance.

The circuit shown in Figure 9 was tested for the full range of capacitor values with no oscillations being observed; thus, problem one has been solved. The frequency and gain characteristics of the circuit are now those of the amplifier and independent of any multiplexing action; thus, problem two has been solved. The multiplexer transition time is approximately $15\mu s$ with the component values shown.

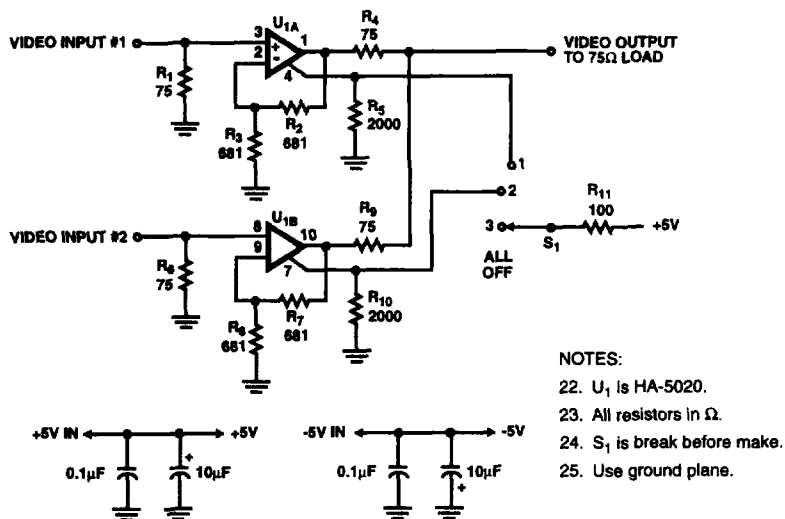

FIGURE 8. TWO CHANNEL HIGH IMPEDANCE MULTIPLEXER

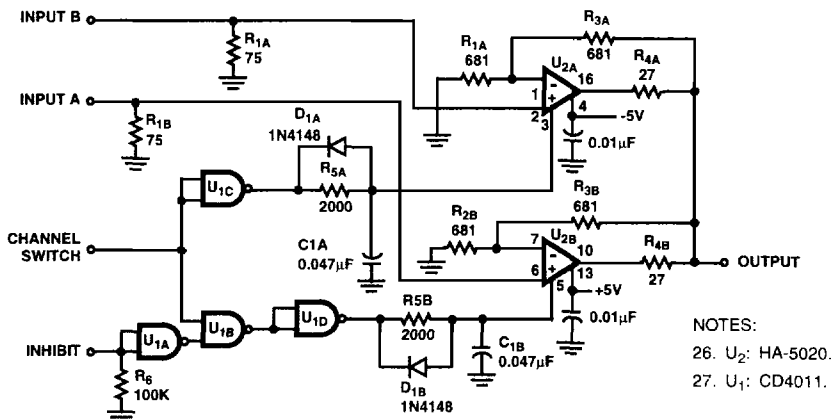

FIGURE 9. LOW IMPEDANCE MULTIPLEXER

Typical Performance Curves $V_{SUPPLY} = \pm 15V$, $A_v = +1$, $R_F = 1k\Omega$, $R_L = 400\Omega$, $T_A = 25^\circ C$,
 Unless Otherwise Specified

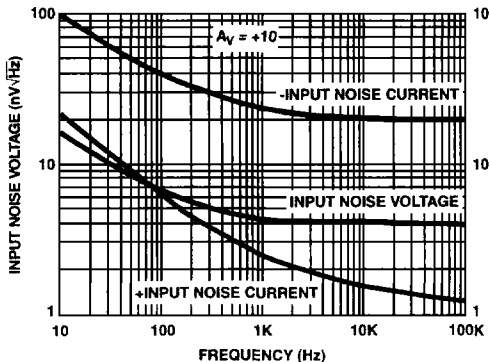

FIGURE 10. INPUT NOISE vs FREQUENCY (AVERAGE OF 18 UNITS FROM 3 LOTS)

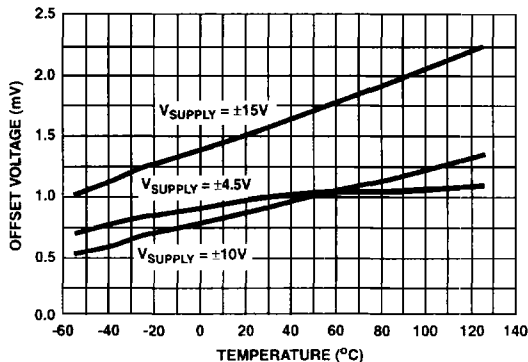

FIGURE 11. INPUT OFFSET VOLTAGE vs TEMPERATURE (ABSOLUTE VALUE AVERAGE OF 30 UNITS FROM 3 LOTS)

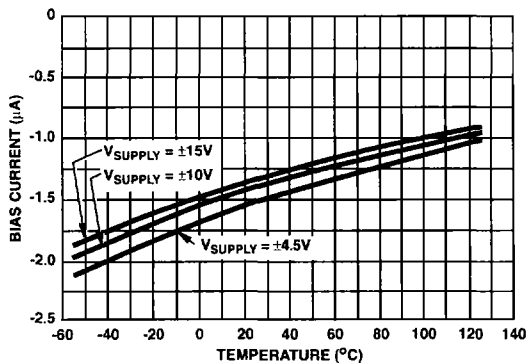

FIGURE 12. +INPUT BIAS CURRENT vs TEMPERATURE (AVERAGE OF 30 UNITS FROM 3 LOTS)

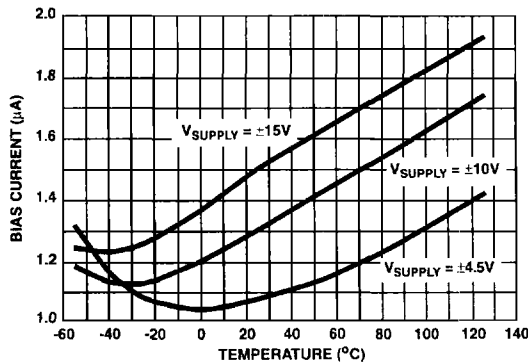

FIGURE 13. -INPUT BIAS CURRENT vs TEMPERATURE (ABSOLUTE VALUE AVERAGE OF 30 UNITS FROM 3 LOTS)

Typical Performance Curves $V_{SUPPLY} = \pm 15V$, $A_V = +1$, $R_F = 1k\Omega$, $R_L = 400\Omega$, $T_A = 25^\circ C$,
Unless Otherwise Specified (Continued)

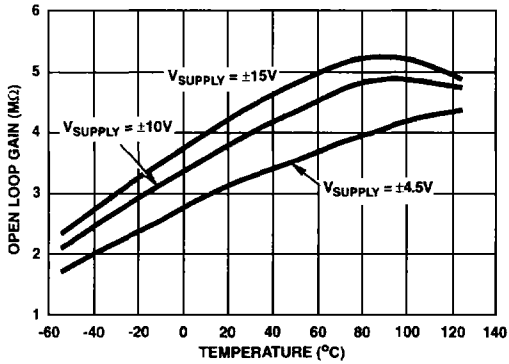

FIGURE 14. TRANSIMPEDANCE vs TEMPERATURE (AVERAGE OF 30 UNITS FROM 3 LOTS)

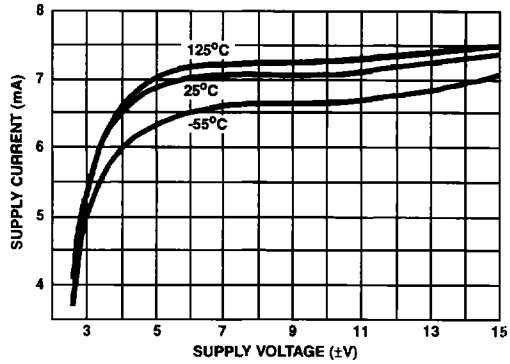

FIGURE 15. SUPPLY CURRENT vs SUPPLY VOLTAGE (AVERAGE OF 30 UNITS FROM 3 LOTS)

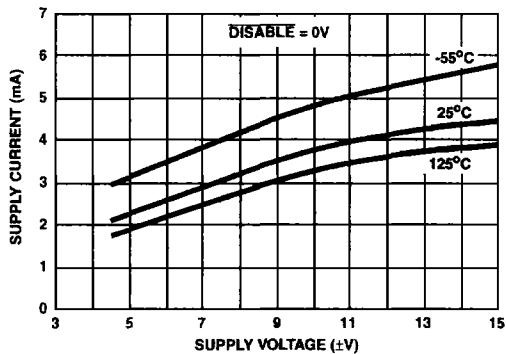

FIGURE 16. DISABLE SUPPLY CURRENT vs SUPPLY VOLTAGE (AVERAGE OF 30 UNITS FROM 3 LOTS)

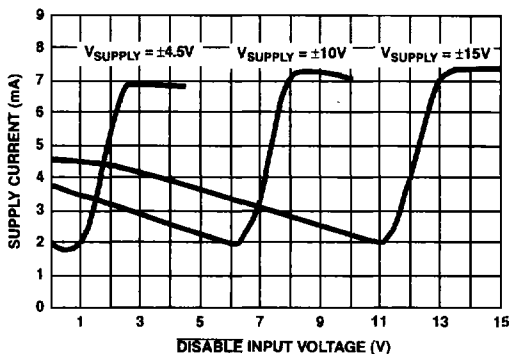

FIGURE 17. SUPPLY CURRENT vs DISABLE INPUT VOLTAGE

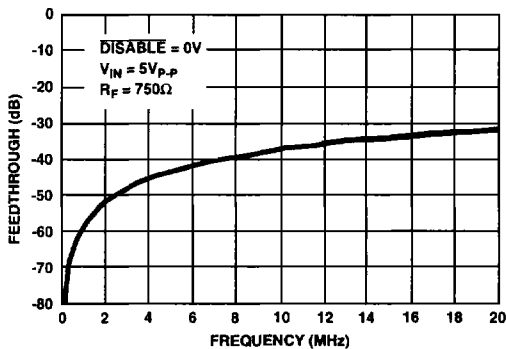

FIGURE 18. DISABLE MODE FEEDTHROUGH vs FREQUENCY

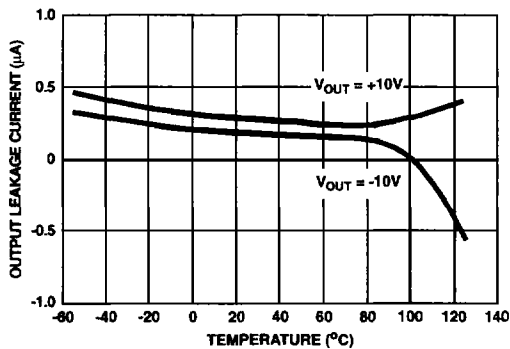

FIGURE 19. DISABLED OUTPUT LEAKAGE vs TEMPERATURE (AVERAGE OF 30 UNITS FROM 3 LOTS)

Typical Performance Curves $V_{SUPPLY} = \pm 15V$, $A_V = +1$, $R_F = 1k\Omega$, $R_L = 400\Omega$, $T_A = 25^\circ C$,
Unless Otherwise Specified (Continued)

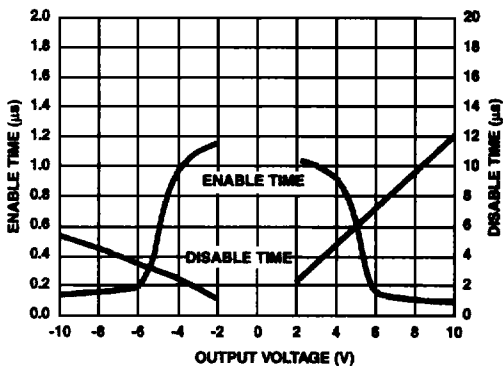

FIGURE 20. ENABLE/DISABLE TIME vs OUTPUT VOLTAGE
(AVERAGE OF 9 UNITS FROM 3 LOTS)

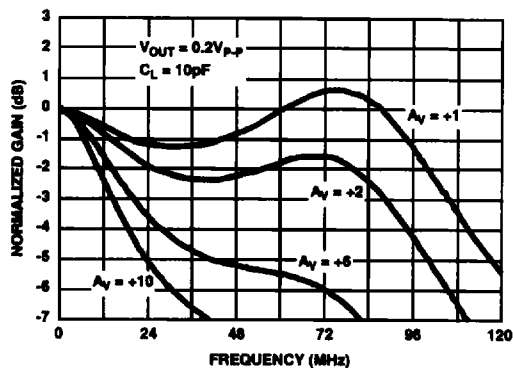

FIGURE 21. NON-INVERTING GAIN vs FREQUENCY

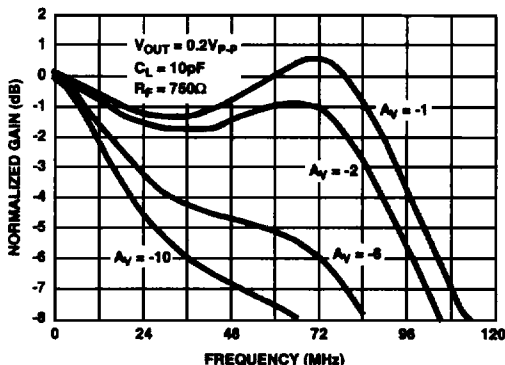

FIGURE 22. INVERTING FREQUENCY RESPONSE

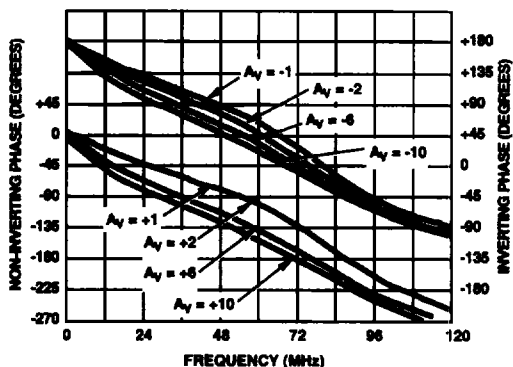

FIGURE 23. PHASE vs FREQUENCY

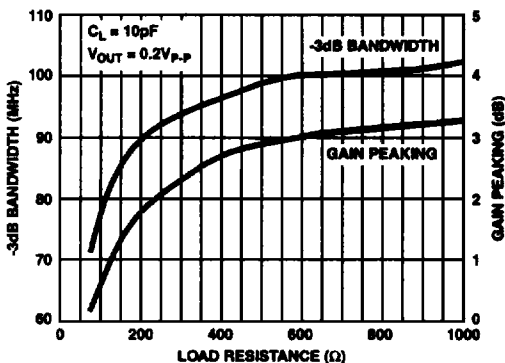

FIGURE 24. BANDWIDTH AND GAIN PEAKING vs LOAD RESISTANCE

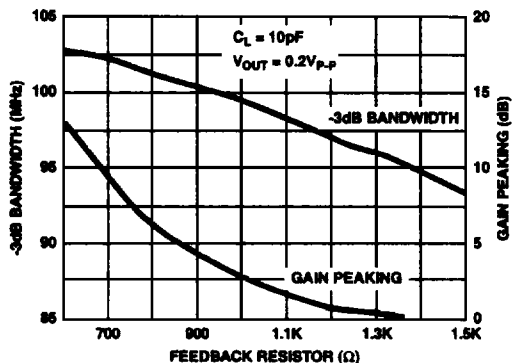

FIGURE 25. BANDWIDTH AND GAIN PEAKING vs FEEDBACK RESISTANCE

Typical Performance Curves

$V_{SUPPLY} = \pm 15V$, $A_V = +1$, $R_F = 1k\Omega$, $R_L = 400\Omega$, $T_A = 25^\circ C$,
Unless Otherwise Specified (Continued)

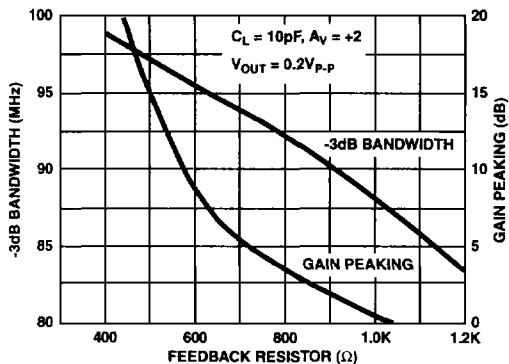

FIGURE 26. BANDWIDTH AND GAIN PEAKING vs FEEDBACK RESISTANCE

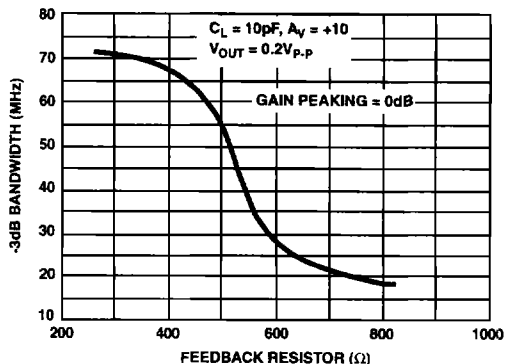

FIGURE 27. BANDWIDTH vs FEEDBACK RESISTANCE

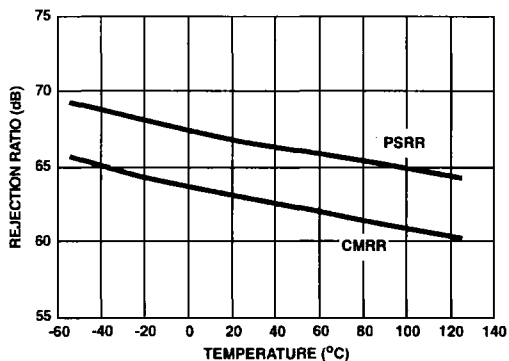

FIGURE 28. REJECTION RATIOS vs TEMPERATURE (AVERAGE OF 30 UNITS FROM 3 LOTS)

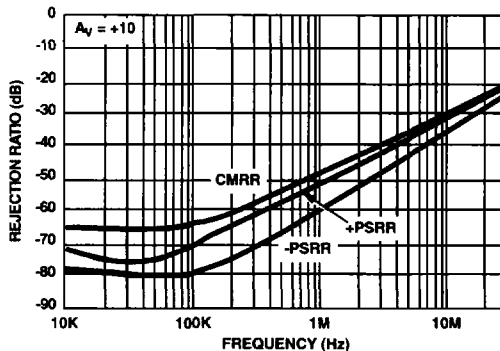

FIGURE 29. REJECTION RATIOS vs FREQUENCY

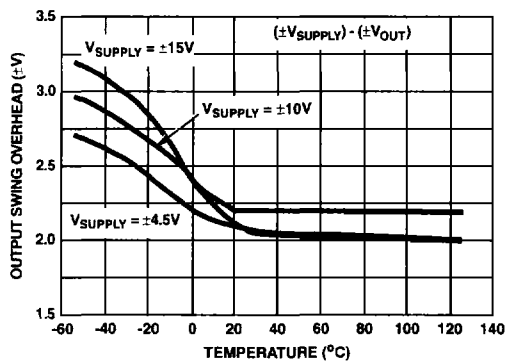

FIGURE 30. OUTPUT SWING OVERHEAD vs TEMPERATURE (AVERAGE OF 30 UNITS FROM 3 LOTS)

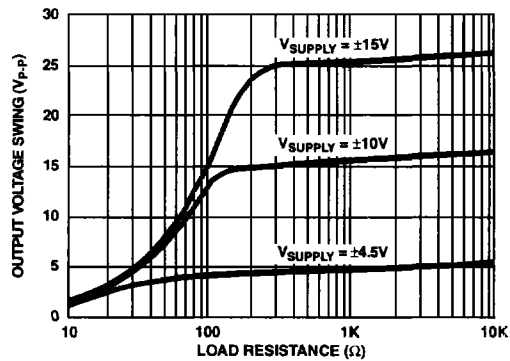

FIGURE 31. OUTPUT VOLTAGE SWING vs LOAD RESISTANCE

Typical Performance Curves $V_{SUPPLY} = \pm 15V$, $A_V = +1$, $R_F = 1k\Omega$, $R_L = 400\Omega$, $T_A = 25^\circ C$.
Unless Otherwise Specified (Continued)

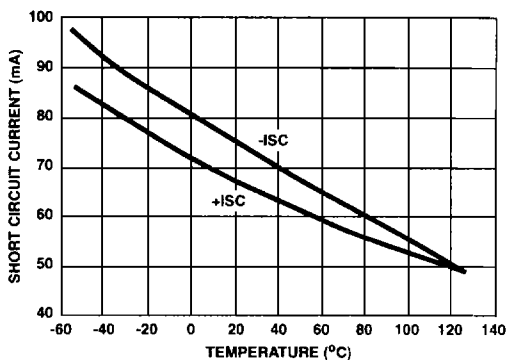

FIGURE 32. SHORT CIRCUIT CURRENT LIMIT vs TEMPERATURE

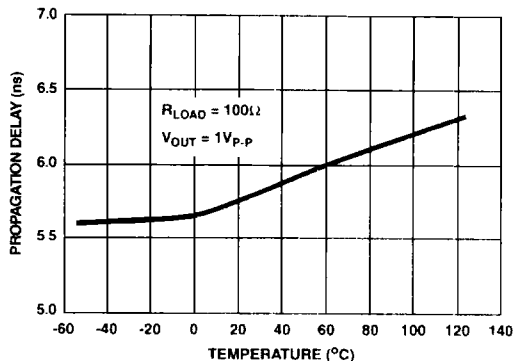

FIGURE 33. PROPAGATION DELAY vs TEMPERATURE (AVERAGE OF 18 UNITS FROM 3 LOTS)

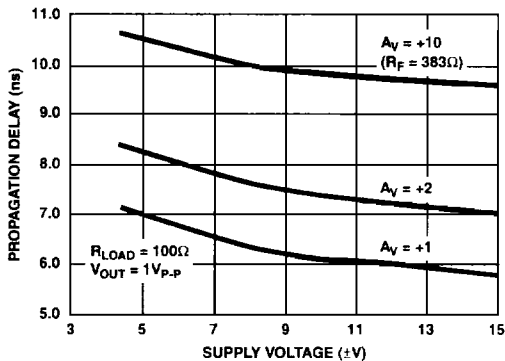

FIGURE 34. PROPAGATION DELAY vs SUPPLY VOLTAGE (AVERAGE OF 18 UNITS FROM 3 LOTS)

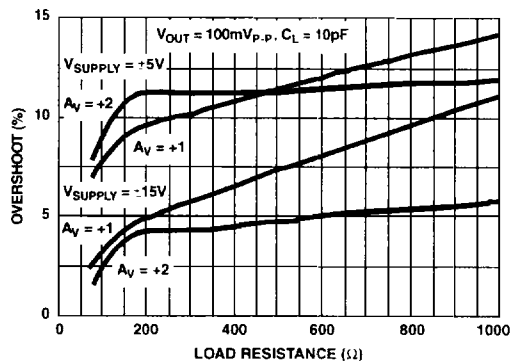

FIGURE 35. SMALL SIGNAL OVERSHOOT vs LOAD RESISTANCE

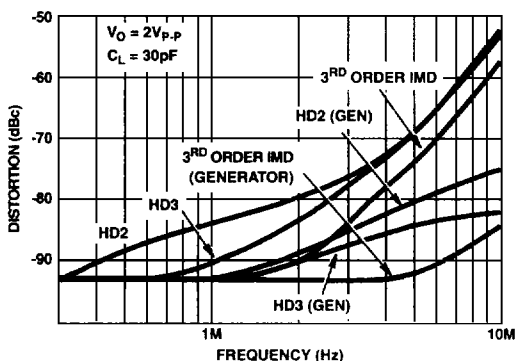

FIGURE 36. DISTORTION vs FREQUENCY

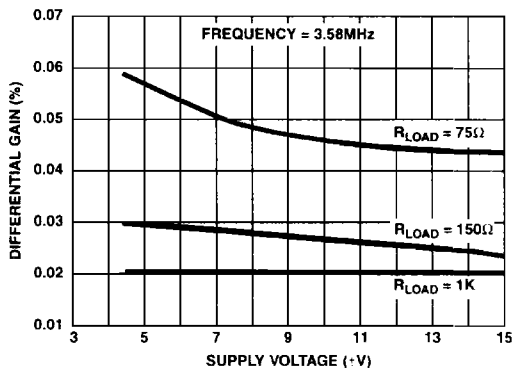

FIGURE 37. DIFFERENTIAL GAIN vs SUPPLY VOLTAGE (AVERAGE OF 18 UNITS FROM 3 LOTS)

Typical Performance Curves $V_{SUPPLY} = \pm 15V$, $A_V = +1$, $R_F = 1k\Omega$, $R_L = 400\Omega$, $T_A = 25^\circ C$, Unless Otherwise Specified (Continued)

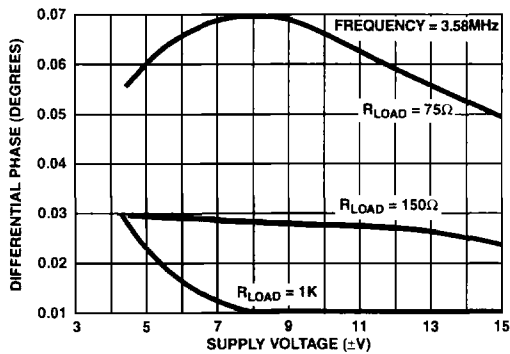

FIGURE 38. DIFFERENTIAL PHASE vs SUPPLY VOLTAGE (AVERAGE OF 18 UNITS FROM 3 LOTS)

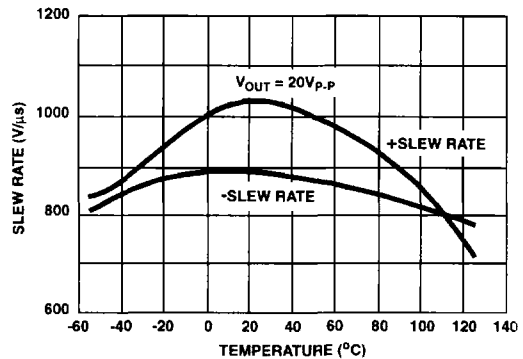

FIGURE 39. SLEW RATE vs TEMPERATURE (AVERAGE OF 30 UNITS FROM 3 LOTS)

Typical Performance Curves $V_{SUPPLY} = \pm 5V$, $A_V = +1$, $R_F = 1k\Omega$, $R_L = 400\Omega$, $T_A = 25^\circ C$, Unless Otherwise Specified

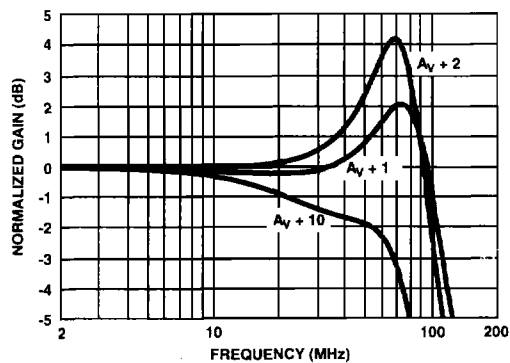

FIGURE 40. NON-INVERTING FREQUENCY RESPONSE

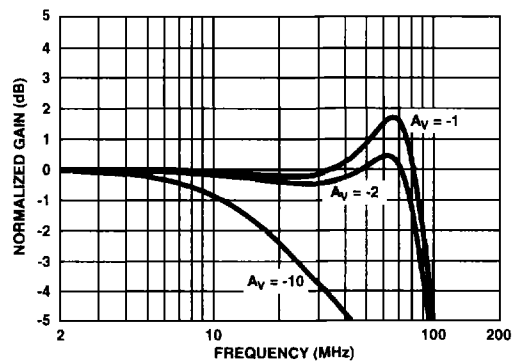

FIGURE 41. INVERTING FREQUENCY RESPONSE

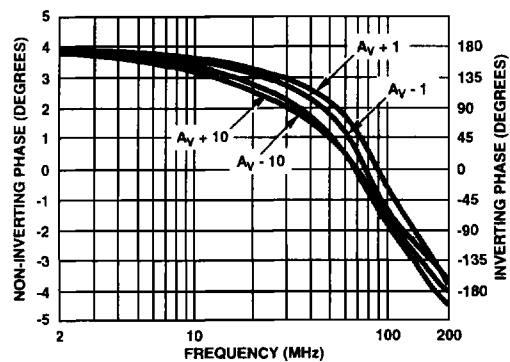

FIGURE 42. PHASE RESPONSE AS A FUNCTION OF FREQUENCY

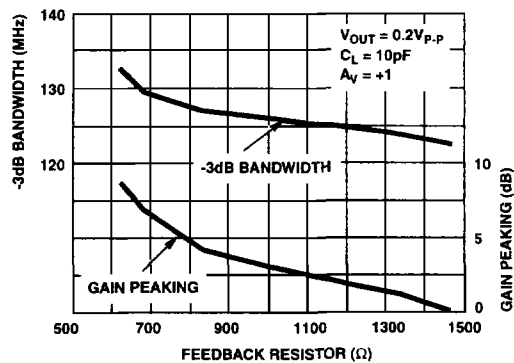

FIGURE 43. BANDWIDTH AND GAIN PEAKING vs FEEDBACK RESISTANCE

3

OPERATIONAL AMPLIFIERS

Typical Performance Curves $V_{SUPPLY} = \pm 5V$, $A_V = +1$, $R_F = 1k\Omega$, $R_L = 400\Omega$, $T_A = 25^\circ C$, Unless Otherwise Specified (Continued)

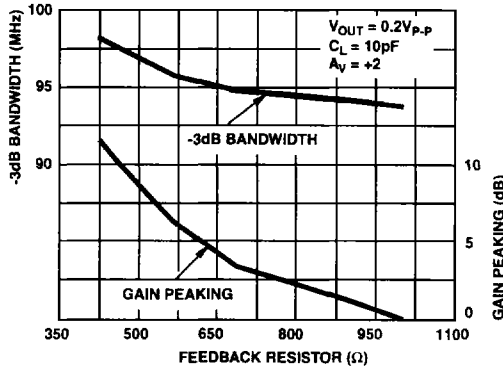

FIGURE 44. BANDWIDTH AND GAIN PEAKING vs FEEDBACK RESISTANCE

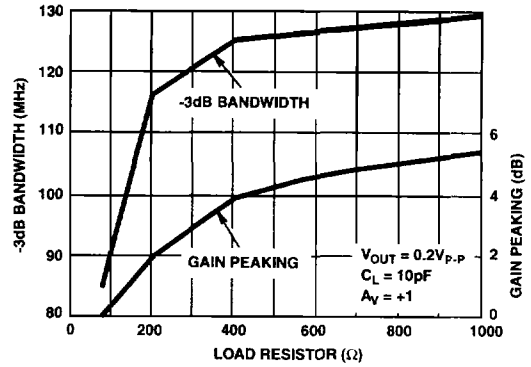

FIGURE 45. BANDWIDTH AND GAIN PEAKING vs LOAD RESISTANCE

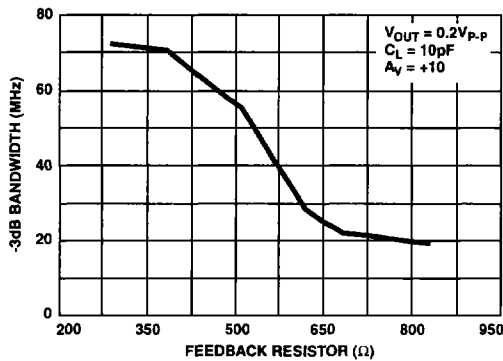

FIGURE 46. BANDWIDTH vs FEEDBACK RESISTANCE

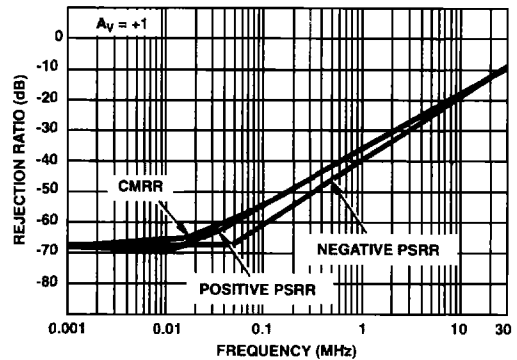

FIGURE 47. REJECTION RATIOS vs FREQUENCY

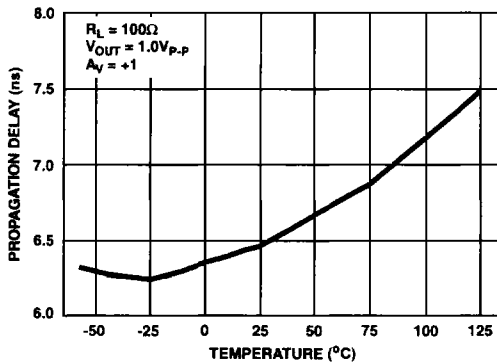

FIGURE 48. PROPAGATION DELAY vs TEMPERATURE

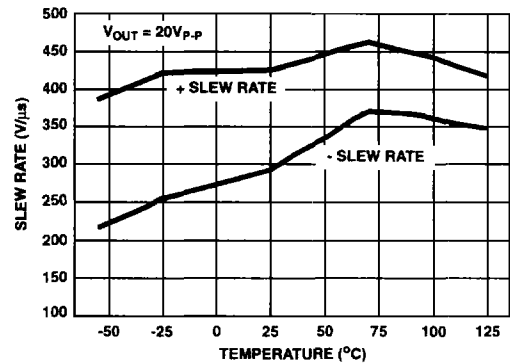

FIGURE 49. SLEW RATE vs TEMPERATURE

Typical Performance Curves $V_{SUPPLY} = \pm 5V$, $A_V = +1$, $R_F = 1k\Omega$, $R_L = 400\Omega$, $T_A = 25^\circ C$, Unless Otherwise Specified (Continued)

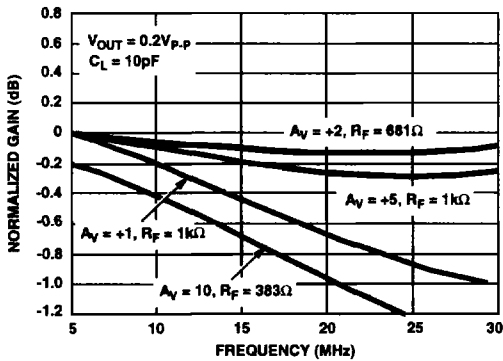

FIGURE 50. NON-INVERTING GAIN FLATNESS vs FREQUENCY

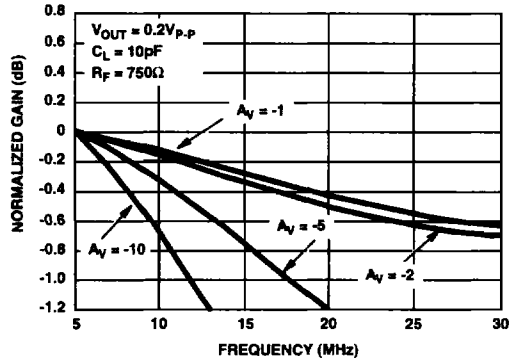

FIGURE 51. INVERTING GAIN FLATNESS vs FREQUENCY

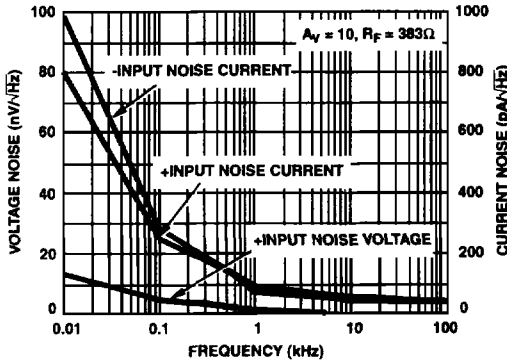

FIGURE 52. INPUT NOISE CHARACTERISTICS

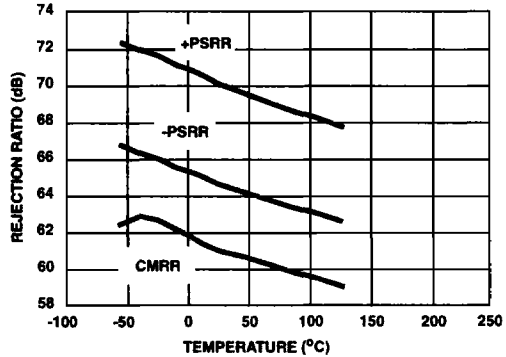

FIGURE 53. REJECTION RATIO vs TEMPERATURE

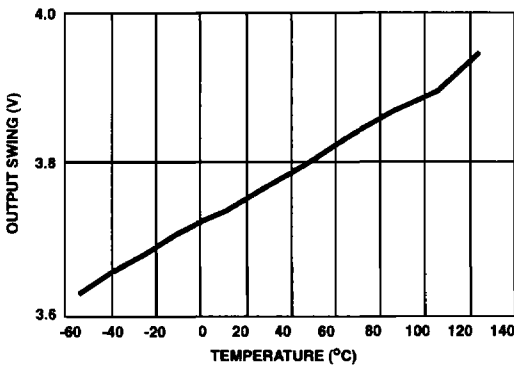

FIGURE 54. OUTPUT SWING vs TEMPERATURE

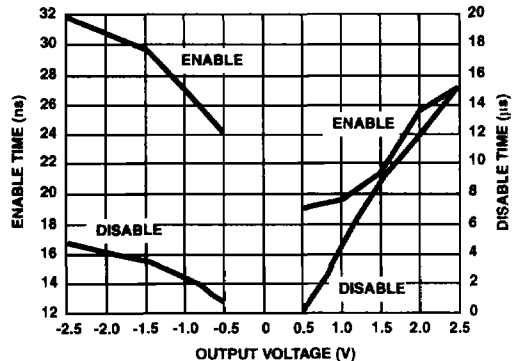

FIGURE 55. ENABLE/DISABLE TIME vs OUTPUT VOLTAGE

Typical Performance Curves $V_{\text{SUPPLY}} = \pm 5\text{V}$, $A_V = +1$, $R_F = 1\text{k}\Omega$, $R_L = 400\Omega$, $T_A = 25^\circ\text{C}$, Unless Otherwise Specified (Continued)

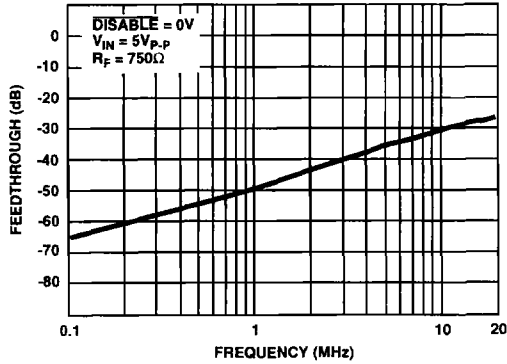

FIGURE 56. DISABLE FEEDTHROUGH vs FREQUENCY

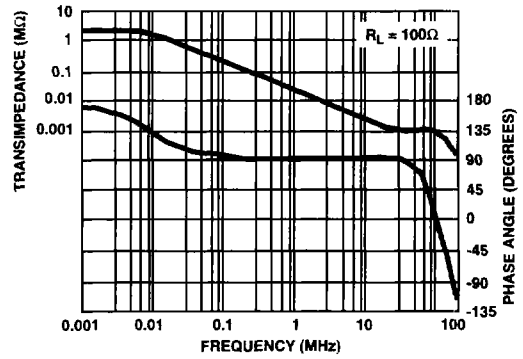

FIGURE 57. TRANSIMPEDANCE vs FREQUENCY

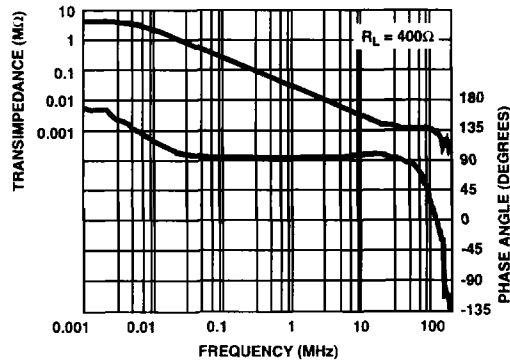

FIGURE 58. TRANSIMPEDANCE vs FREQUENCY

HA-5020

Die Characteristics

DIE DIMENSIONS:

1640 μ m x 1520 μ m x 483 μ m

METALLIZATION:

Type: Aluminum, 1% Copper

Thickness: 16k \AA \pm 2k \AA

SUBSTRATE POTENTIAL (Powered Up):

V-

PASSIVATION:

Type: Nitride over Silox

Silox Thickness: 12k \AA \pm 2k \AA

Nitride Thickness: 3.5k \AA \pm 1k \AA

TRANSISTOR COUNT:

62

PROCESS:

High Frequency Bipolar Dielectric Isolation

Metallization Mask Layout

HA-5020

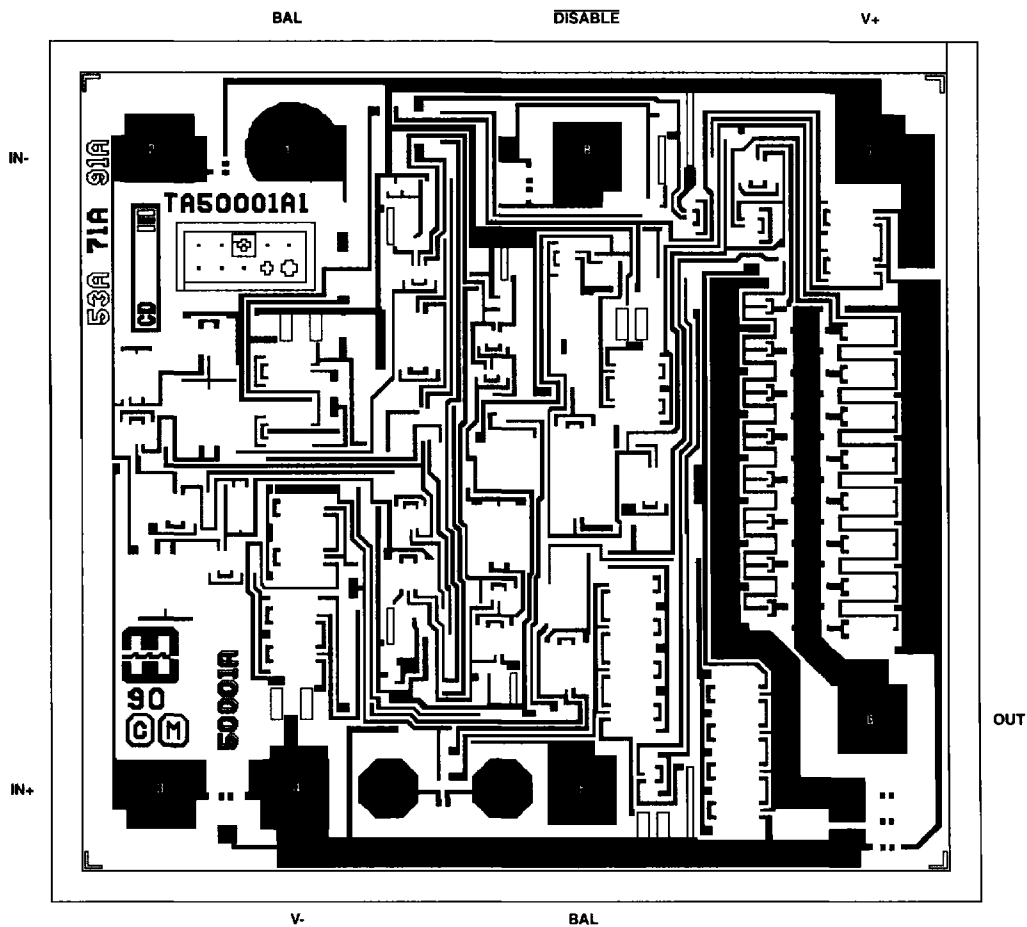

3

OPERATIONAL
AMPLIFIERS