



SY100EP16V

3.3V/5V Precision ECL Differential Receiver/Driver

General Description

The SY100EP16V is a 3.3/5V, high-speed, fully differential ECL Receiver/Driver that can process clock signals as fast as 3GHz or data patterns up to 2.5Gbps.

The differential input includes an internal 75k Ω pull-down resistor on both the true and complement inputs and a 37.5k Ω pull-up resistor in the complement input only. For AC-coupled input interface applications, an integrated voltage reference (V_{BB}) is provided to bias for either single-ended use or for DC biasing when AC coupling to the device. The V_{BB} pin should be used only as a bias for the SY100EP16V since its current sink/source capability is limited. Whenever used, the V_{BB} pin should be bypassed to the most positive supply voltage. The output is 800mV ECL, with fast rise/fall times guaranteed to be less than 200ps.

When the inputs are left open, the internal input clamps will force the Q output low.

The SY100EP16V operates from a 3.3V or 5V $\pm 10\%$ supply and is guaranteed over the full industrial temperature range (-40°C to $+85^{\circ}\text{C}$). The SY100EP16V is part of Micrel's high-speed, Precision Edge[®] product line.

Datasheets and support documentation can be found on Micrel's web site at: www.micrel.com.

Functional Block Diagram

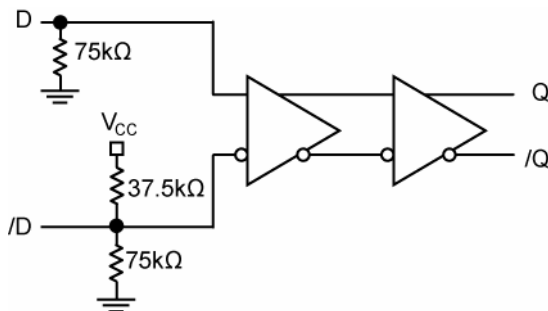

Precision Edge[®]

Features

- Precision 800mV ECL Receiver/Driver
- 100K ECL compatible I/O
- Guaranteed AC performance over temperature and voltage:
 - DC-to > 2.5Gbps throughput
 - 220ps typical propagation delay (D-to-Q)
 - <200ps rise/fall times
- PECL and NECL operation capability
- PECL operating range: $V_{CC} = 3.0\text{V}$ to 5.5V with $V_{EE} = 0\text{V}$
- NECL operating range: $V_{CC} = 0\text{V}$ with $V_{EE} = -3.0\text{V}$ to -5.5V
- 3.3V $\pm 10\%$ or 5.0V $\pm 10\%$ power supply operation
- Industrial temperature range: -40°C to $+85^{\circ}\text{C}$
- Available in 8-pin (2mm x 2mm) MLF[®], 8-pin MSOP, and 8-pin SOIC packages

Applications

- All SONET clock and data distribution
- Fibre Channel clock and data distribution
- Gigabit Ethernet clock and data distribution
- Backplane distribution

Markets

- Storage
- ATE
- Test and measurement
- Enterprise networking equipment
- High-end servers
- Access
- Metro area network equipment

Precision Edge is a registered trademark of Micrel, Inc.
MLF and MicroLeadFrame are registered trademarks of Amkor Technology.

Micrel Inc. • 2180 Fortune Drive • San Jose, CA 95131 • USA • tel +1 (408) 944-0800 • fax +1 (408) 474-1000 • <http://www.micrel.com>

Ordering Information⁽¹⁾

Part Number	Package Type	Operating Range	Package Marking	Lead Finish
SY100EP16VMG	MLF-8	Industrial	162 with Pb-Free bar-line indicator	NiPdAu Pb-Free
SY100EP16VMGTR ⁽²⁾	MLF-8	Industrial	162 with Pb-Free bar-line indicator	NiPdAu Pb-Free
SY100EP16VZG	SOIC-8	Industrial	XEP16V with Pb-Free bar-line indicator	NiPdAu Pb-Free
SY100EP16VZGTR ⁽²⁾	SOIC-8	Industrial	XEP16V with Pb-Free bar-line indicator	NiPdAu Pb-Free
SY100EP16VKG	MSOP-8	Industrial	XP16V with Pb-Free bar-line indicator	NiPdAu Pb-Free
SY100EP16VKGTR ⁽²⁾	MSOP-8	Industrial	XP16V with Pb-Free bar-line indicator	NiPdAu Pb-Free

Notes:

1. Contact factory for die availability. Dice are guaranteed at T_A = 25°C, DC Electricals only.
2. Tape and Reel.

Pin Configuration

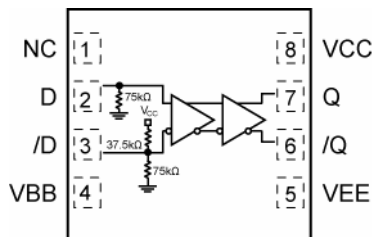

8-Pin MLF[®] (MLF-8)

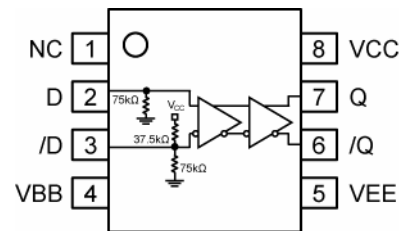

8-pin SOIC (SOIC-8)
8-pin MSOP (MSOP-8)

Pin Description

Pin Number	Pin Name	Pin Function
2, 3	D, /D	ECL Inputs. The D input has an internal 75kΩ pull-down resistor and the /D has an internal 37.5kΩ pull-up and a 75kΩ pull-down resistor.
7, 6	Q, /Q	ECL Outputs. Terminate with 50Ω to V _{CC} -2V. See “Output Interface Applications” section for more details.
4	V _{BB}	Reference Output Voltage: This reference is typically used to bias the unused inverting input for single-ended input applications, or as the termination point for AC-coupled differential input applications. V _{BB} reference value is approximately V _{CC} - 1.42V, and tracks V _{CC} 1:1. Maximum sink/source capability for V _{BB} is 0.50mA. For single ended inputs, connect to the unused input through a 50Ω resistor. Decouple the V _{BB} pin with a 0.01μF capacitor to V _{CC} .
8	V _{CC}	Positive Power Supply: Bypass with 0.1μF//0.01μF low ESR capacitors as close to the V _{CC} pin as possible.
5	V _{EE}	Negative Power Supply: V _{EE} and exposed pad must be tied to the most negative supply. Exposed pad is available for 8-pin MLF [®] package only.

Absolute Maximum Ratings⁽¹⁾

Supply Voltage	
PECL Mode (V_{CC})	+6V
NECL Mode (V_{EE})	-6V
Current (I_{BB})	
Source or Sink current on V_{BB}	± 0.5 mA
Input Voltage (V_{IN})	
PECL Mode	V_{CC} to 0V
NECL Mode	0V to V_{EE}
Output Current (I_{OUT})	
Continuous	50mA
Surge	100mA
Lead Temperature (soldering, 20sec.)	260°C
Storage Temperature (T_s)	-65°C to +150°C

Operating Ratings⁽²⁾

Supply Voltage (V_{CC})	
PECL Mode ($V_{EE} = 0$ V)	+3.0V to +5.5V
Supply Voltage (V_{EE})	
NECL Mode ($V_{CC} = 0$ V)	-3.0V to -5.5V
Ambient Temperature (T_A)	-40°C to +125°C
Junction Thermal Resistance	
MLF [®] (θ_{JA})	90°C/W
MSOP (θ_{JA})	160°C/W
SOIC (θ_{JA})	99°C/W

100EP DC Electrical Characteristics⁽³⁾

$V_{CC} = 3.3V \pm 10\%$, $V_{EE} = 0V$; $T_A = -40^\circ C$ to $+85^\circ C$, unless otherwise stated⁽⁴⁾

Symbol	Parameter	-40°C			25°C			85°C			Units
		Min	Typ	Max	Min	Typ	Max	Min	Typ	Max	
I_{EE}	Power Supply Current		22	30		22	30		22	30	mA
V_{OH}	Output HIGH Voltage ⁽⁵⁾	2155	2280	2405	2155	2280	2405	2155	2280	2405	mV
V_{OL}	Output LOW Voltage ⁽⁵⁾	1355	1480	1605	1355	1480	1605	1355	1480	1605	mV
V_{IH}	Input HIGH Voltage	2075		2420	2075		2420	2075		2420	mV
V_{IL}	Input LOW Voltage	1355		1675	1355		1675	1355		1675	mV
V_{BB}	Output Voltage Reference	1775	1875	1975	1775	1875	1975	1775	1875	1975	mV
V_{IHCMR}	Input HIGH Voltage Common Mode Range (Differential Configuration) ⁽⁶⁾	2.0		3.3	2.0		3.3	2.0		3.3	V
I_{IH}	Input HIGH Current			150			150			150	μ A
I_{IL}	Input LOW Current	D /D	0.5 -150		0.5 -150			0.5 -150			μ A

Notes:

1. Permanent device damage may occur if absolute maximum ratings are exceeded. This is a stress rating only and functional operation is not implied at conditions other than those detailed in the operational sections of this data sheet. Exposure to absolute maximum ratings conditions for extended periods may affect device reliability.
2. The datasheet limits are not guaranteed if the device is operated beyond the operating ratings.
3. The circuit is designed to meet the DC specifications shown in the above table after thermal equilibrium has been established.
4. Input and output parameters vary 1:1 with V_{CC} .
5. All loading with 50 Ω to $V_{CC}-2.0V$.
6. V_{IHCMR} (min) varies 1:1 with V_{EE} , V_{IHCMR} (max) varies 1:1 with V_{CC} . The V_{IHCMR} range is referenced to the most positive side of the differential input signal.

100EP DC Electrical Characteristics⁽⁷⁾
 $V_{CC} = 5V \pm 10\%$, $V_{EE} = 0V$; $T_A = -40^\circ C$ to $+85^\circ C$, unless otherwise stated.⁽⁸⁾

Symbol	Parameter	-40°C			25°C			85°C			Units
		Min	Typ	Max	Min	Typ	Max	Min	Typ	Max	
I_{EE}	Power Supply Current		22	30		22	30		22	30	mA
V_{OH}	Output HIGH Voltage ⁽⁹⁾	3855	3980	4105	3855	3980	4105	3855	3980	4105	mV
V_{OL}	Output LOW Voltage ⁽⁹⁾	3055	3180	3305	3055	3180	3305	3055	3180	3305	mV
V_{IH}	Input HIGH Voltage (Single-Ended)	3775		4120	3775		4120	3775		4120	mV
V_{IL}	Input LOW Voltage (Single-Ended)	3055		3375	3055		3375	3055		3375	mV
V_{BB}	Output Voltage Reference	3475	3575	3675	3475	3575	3675	3475	3575	3675	mV
V_{IHCMR}	Input HIGH Voltage Common Mode Range (Differential Configuration) ⁽¹⁰⁾	2.0		5.0	2.0		5.0	2.0		5.0	V
I_{IH}	Input HIGH Current			150			150			150	μA
I_{IL}	Input LOW Current	D /D	0.5 -150		0.5 -150			0.5 -150			μA

100EP DC Electrical Characteristics⁽⁷⁾
 $V_{CC} = 0V$, $V_{EE} = -5.5V$ to $-3.0V$; $T_A = -40^\circ C$ to $+85^\circ C$, unless otherwise stated.⁽⁸⁾

Symbol	Parameter	-40°C			25°C			85°C			Units
		Min	Typ	Max	Min	Typ	Max	Min	Typ	Max	
I_{EE}	Power Supply Current		22	30		22	30		22	30	mA
V_{OH}	Output HIGH Voltage ⁽⁹⁾	- 1145	- 1020	- 0895	- 1145	- 1020	- 0895	- 1145	- 1020	- 895	mV
V_{OL}	Output LOW Voltage ⁽⁹⁾	- 1945	-1820	-1695	- 1945	-1820	-1695	- 1945	-1820	-1695	mV
V_{IH}	Input HIGH Voltage (Single-Ended)	-1225		-0.880	-1225		-0.880	-1225		-0.880	mV
V_{IL}	Input LOW Voltage (Single-Ended)	- 1945		-1625	- 1945		-1625	- 1945		-1625	mV
V_{BB}	Output Voltage Reference	-1525	-1425	- 1325	-1525	-1425	- 1325	-1525	-1425	- 1325	mV
V_{IHCMR}	Input HIGH Voltage Common Mode Range (Differential Configuration) ⁽¹⁰⁾	$V_{EE} + 2.0$		0	$V_{EE} + 2.0$		0	$V_{EE} + 2.0$		0	V
I_{IH}	Input HIGH Current			150			150			150	μA
I_{IL}	Input LOW Current	D /D	0.5 -150		50 -150			50 -150			μA

Notes:

- The circuit is designed to meet the DC specifications shown in the above table after thermal equilibrium has been established.
- Input and output parameters vary 1:1 with V_{CC} .
- All loading with 50Ω to $V_{CC}-2.0V$.
- V_{IHCMR} (min) varies 1:1 with V_{EE} , V_{IHCMR} (max) varies 1:1 with V_{CC} . The V_{IHCMR} range is referenced to the most positive side of the differential input signal.

AC Electrical Characteristics

$V_{CC} = 0V$, $V_{EE} = -5.5V$ to $-3.0V$; $V_{CC} = 3.0V$ to $5.5V$, $V_{EE} = 0V$; $T_A = -40^{\circ}C$ to $+85^{\circ}C$, unless otherwise stated.⁽¹¹⁾

Symbol	Parameters	-40°C			25°C			85°C			Units
		Min	Typ	Max	Min	Typ	Max	Min	Typ	Max	
f _{MAX}	Maximum Frequency		2.5			2.5			2.5		Gbps
		3	4		3	4		3	4		GHz
t _{PLH} t _{PHL}	Propagation Delay to Output Differential D→Q, /Q (Figure 1)	150	220	280	150	220	280	160	240	300	ps
t _{Skew}	Duty Cycle Skew ⁽¹²⁾		5	20		5	20		5	20	ps
t _{JITTER}	Cycle-to-Cycle Jitter ⁽¹³⁾		0.2	1		0.2	1		0.2	1	ps
V _{PP}	Input Voltage Swing (Differential Configuration)	150	800	1200	150	800	1200	150	800	1200	mV
t _r , t _f	Output Rise/Fall Times (20% to 80%) Q, /Q	70	120	170	80	130	180	100	150	200	ps

Notes:

- Measured using a 750mV source, 50% duty cycle input. 50Ω to V_{CC} -2V loading.
- Skew is measured between outputs under identical transitions. It is defined only for differential operation where the delays are measured from the cross point of the inputs to the cross point of the outputs.
- Cycle-to-cycle jitter definition: the variation period between adjacent cycles over a random sample of adjacent cycle pairs. $t_{JITTER_CC} = T_n - T_{n+1}$, where T is the time between rising edges of the output signal.

Typical Characteristics

$V_{CC} = 3.3V$, $GND = 0V$, $V_{IN} = 800mV$, $R_L = 50\Omega$ to $V_{CC}-2V$, $T_A = 25^\circ C$, unless otherwise stated.

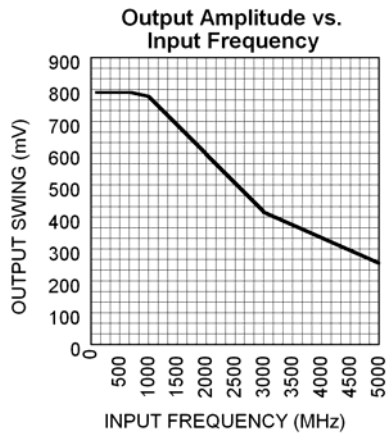

Functional Characteristics

$V_{CC} = 3.3V$, $GND = 0V$, $V_{IN} = 150mV$, Data Pattern: $2^{23}-1$, $R_L = 50\Omega$ to $V_{CC}-2V$, $T_A = 25^\circ C$, unless otherwise stated.

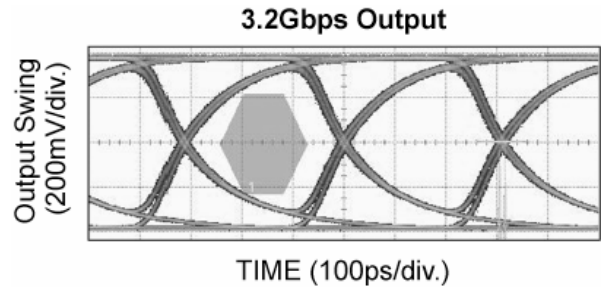
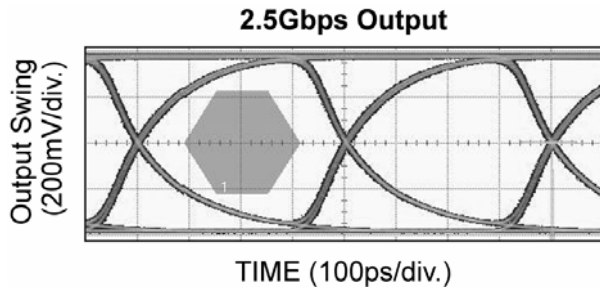
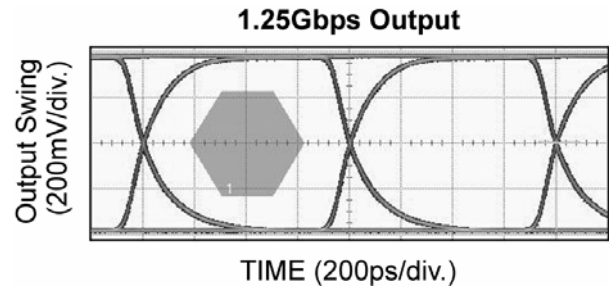
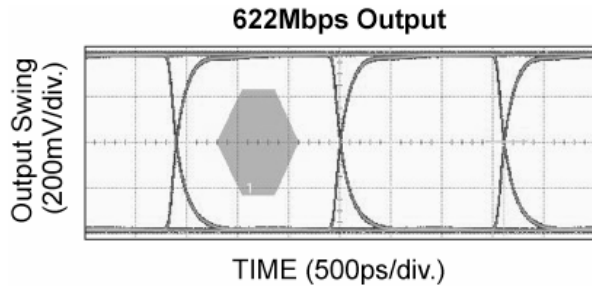

Functional Characteristics (continued)

$V_{CC} = 3.3V$, $GND = 0V$, $V_{IN} = 150mV$, $R_L = 50\Omega$ to $V_{CC}-2V$, $T_A = 25^\circ C$, unless otherwise stated.

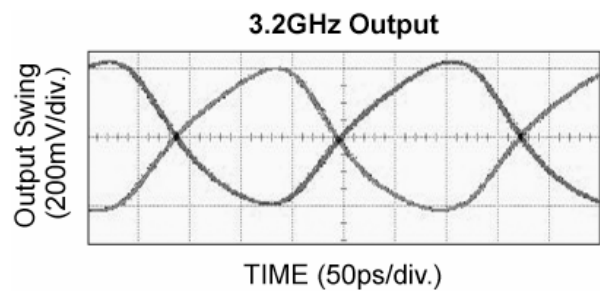
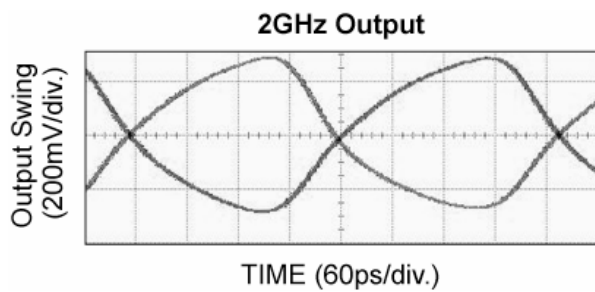
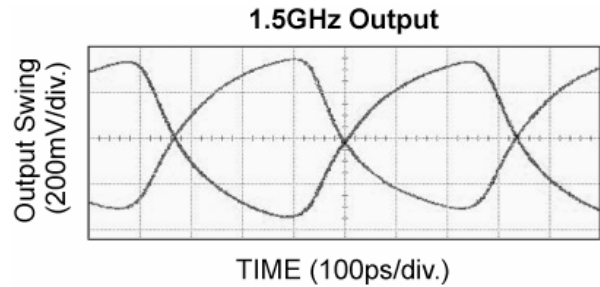
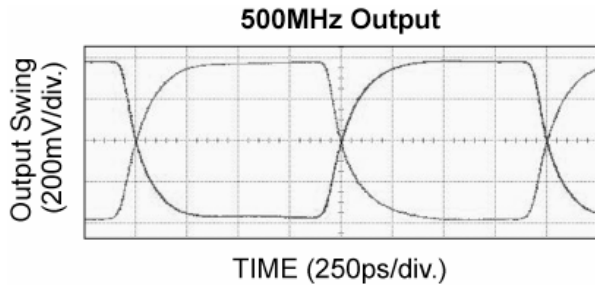

Single-Ended and Differential Swings



Figure 1a. Single-Ended Swing

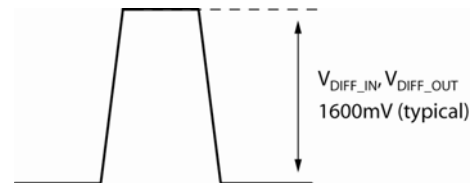

Figure 1b. Differential Swing

Output Interface Applications

ECL outputs have very low output impedance (open emitter), and small signal swing which results in low EMI. ECL is ideal for driving 50Ω-and-100Ω-controlled impedance transmission lines. There are several techniques in terminating the ECL output, as shown in Figure 2a and 2b.

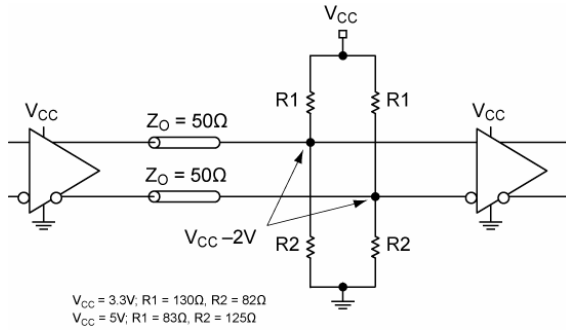

Figure 2a. Parallel Termination-Thevenin Equivalent

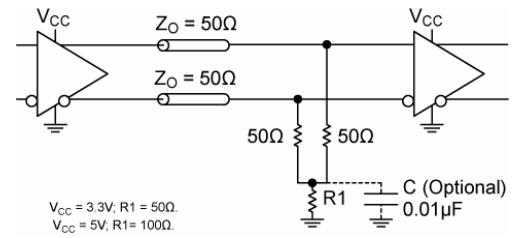
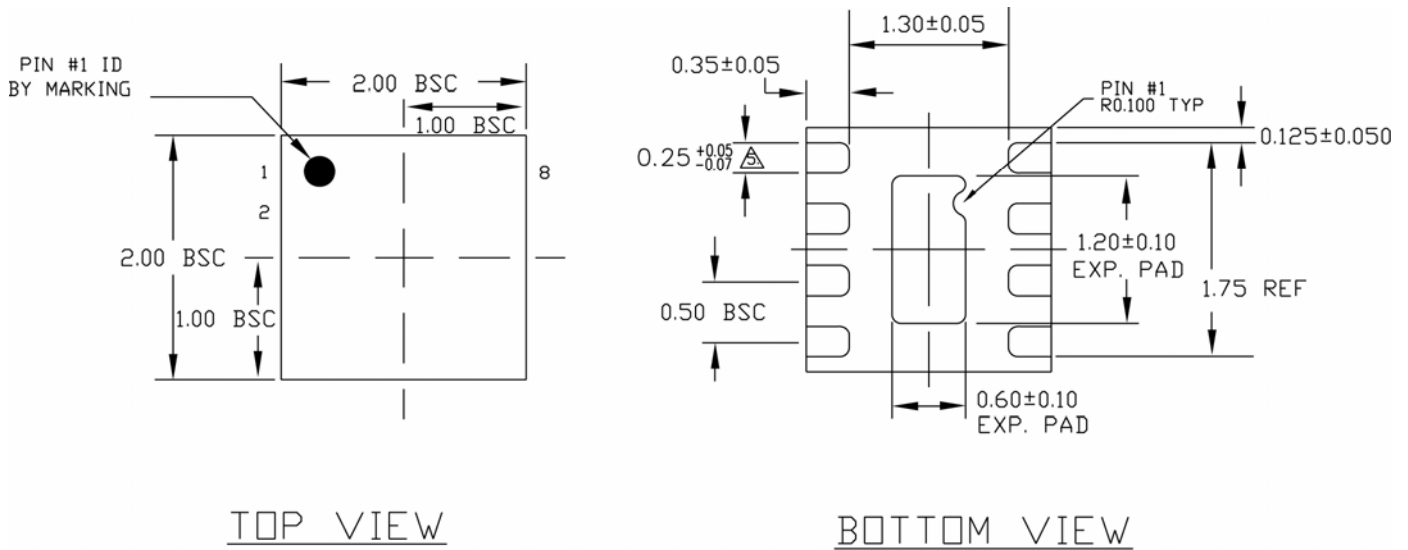

Figure 2b. Three-Resistor “Y-Termination”

Related Product and Support Documents

Part Number	Function	Datasheet Link
HBW Solutions	New Products and Termination Application Notes	http://www.micrel.com/page.do?page=/product-info/as/HBWsolutions.shtml

Package Information



TOP VIEW

BOTTOM VIEW

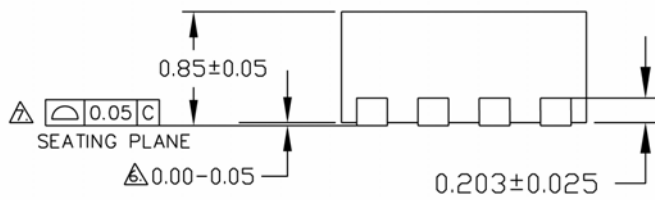

SIDE VIEW

NOTE:

1. ALL DIMENSIONS ARE IN MILLIMETERS.
 2. MAX. PACKAGE WARPAGE IS 0.05 mm.
 3. MAXIMUM ALLOWABLE BURRS IS 0.076 mm IN ALL DIRECTIONS.
 4. PIN #1 ID ON TOP WILL BE LASER/INK MARKED.
- DIMENSION APPLIES TO METALIZED TERMINAL AND IS MEASURED BETWEEN 0.20 AND 0.25 mm FROM TERMINAL TIP.
 APPLIED ONLY FOR TERMINALS.
 APPLIED FOR EXPOSED PAD AND TERMINALS.

Rev. B

8-Pin (2mm x 2mm) MLF[®] (MLF-8)

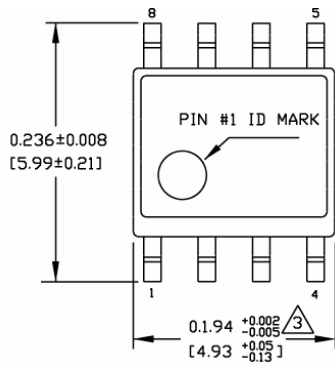

TOP VIEW

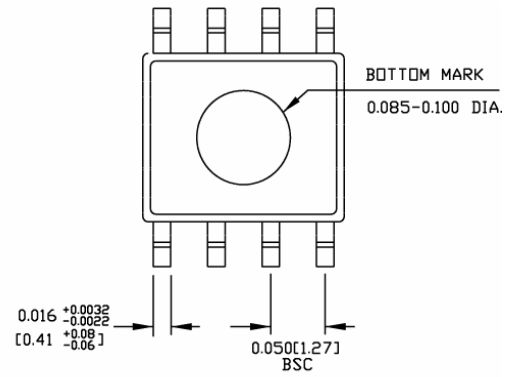

BOTTOM VIEW

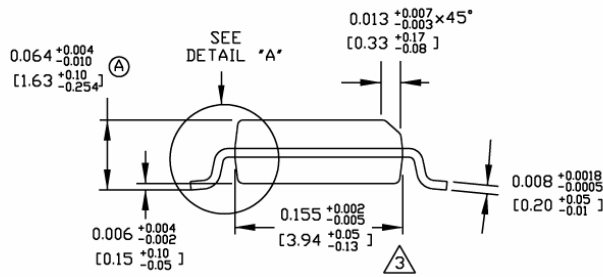

END VIEW

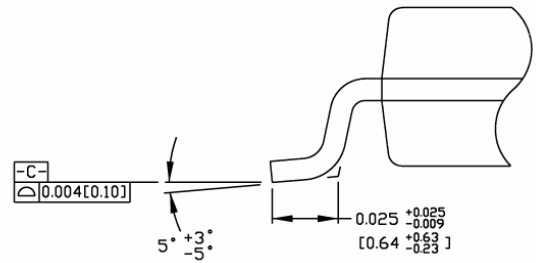

DETAIL "A"

NOTES:

1. DIMENSIONS ARE IN INCHES[MM].
2. CONTROLLING DIMENSION: INCHES.
3. DIMENSION DOES NOT INCLUDE MOLD FLASH OR PROTRUSIONS, EITHER OF WHICH SHALL NOT EXCEED 0.010[0.25] PER SIDE.

8-Pin SOIC (SOIC-8)

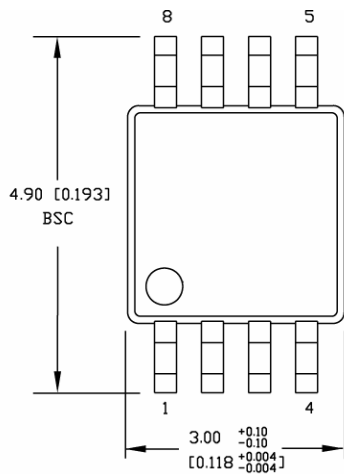

TOP VIEW

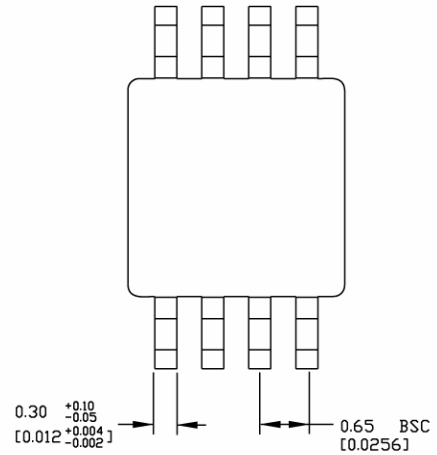

BOTTOM VIEW

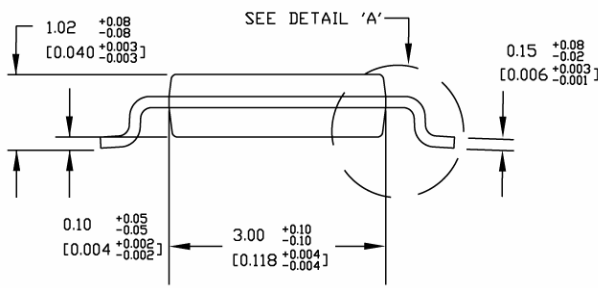

SIDE VIEW

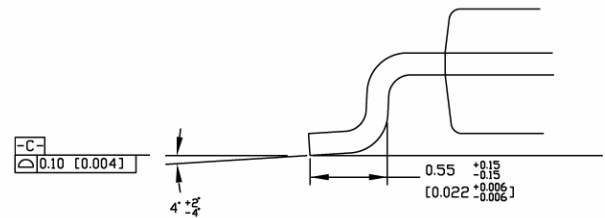

DETAIL A

NOTES:

1. DIMENSIONS ARE IN MM [INCHES].
2. CONTROLLING DIMENSION: MM
3. DIMENSION DOES NOT INCLUDE MOLD FLASH OR PROTRUSIONS, EITHER OF WHICH SHALL NOT EXCEED 0.20 [0.008] PER SIDE.

8-Pin MSOP (MSOP-8)

MICREL, INC. 2180 FORTUNE DRIVE SAN JOSE, CA 95131 USA
 TEL +1 (408) 944-0800 FAX +1 (408) 474-1000 WEB <http://www.micrel.com>

The information furnished by Micrel in this data sheet is believed to be accurate and reliable. However, no responsibility is assumed by Micrel for its use. Micrel reserves the right to change circuitry and specifications at any time without notification to the customer.

Micrel Products are not designed or authorized for use as components in life support appliances, devices or systems where malfunction of a product can reasonably be expected to result in personal injury. Life support devices or systems are devices or systems that (a) are intended for surgical implant into the body or (b) support or sustain life, and whose failure to perform can be reasonably expected to result in a significant injury to the user. A Purchaser's use or sale of Micrel Products for use in life support appliances, devices or systems is a Purchaser's own risk and Purchaser agrees to fully indemnify Micrel for any damages resulting from such use or sale.

© 2008 Micrel, Incorporated.