

## μCap 80 mA LDO Regulator

### Features

- Tiny 4- and 5-Lead Surface-Mount Packages
- Wide Selection of Output Voltages
- Guaranteed 80 mA Output
- Low Quiescent Current
- Low Dropout Voltage
- Low Temperature Coefficient
- Current and Thermal Limiting
- Reversed Input Polarity Protection
- Zero Off-Mode Current
- Logic-Controlled Shutdown
- Stability with Low-ESR Ceramic Capacitors

### Applications

- Cellular Telephones
- Laptop, Notebook, and Palmtop Computers
- Battery-Powered Equipment
- Barcode Scanners
- SMPS Post-Regulator and DC/DC Modules
- High-Efficiency Linear Power Supplies

### General Description

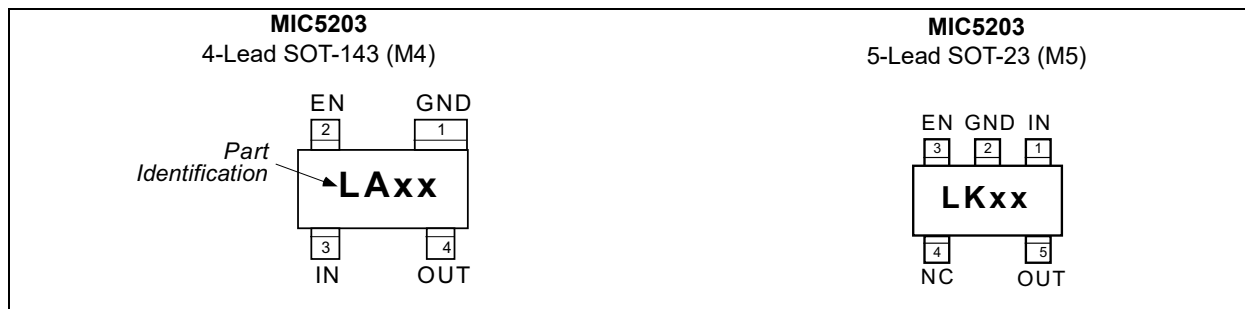
The MIC5203 is a μCap 80 mA linear voltage regulator with very low dropout voltage (typically 20 mV at light loads and 300 mV at 80 mA) and very low ground current (225 μA at 20 mA output), offering better than 3% initial accuracy with a logic-compatible enable input.

The μCap regulator design is optimized to work with low-value, low-cost ceramic capacitors. The outputs typically require only 0.47 μF of output capacitance for stability.

Designed especially for hand-held, battery-powered devices, the MIC5203 can be controlled by a CMOS or TTL compatible logic signal. When disabled, power consumption drops nearly to zero. If on-off control is not required, the enable pin may be tied to the input for 3-terminal operation. The ground current of the MIC5203 increases only slightly in dropout, further prolonging battery life. Key MIC5203 features include current limiting, overtemperature shutdown, and protection against reversed battery.

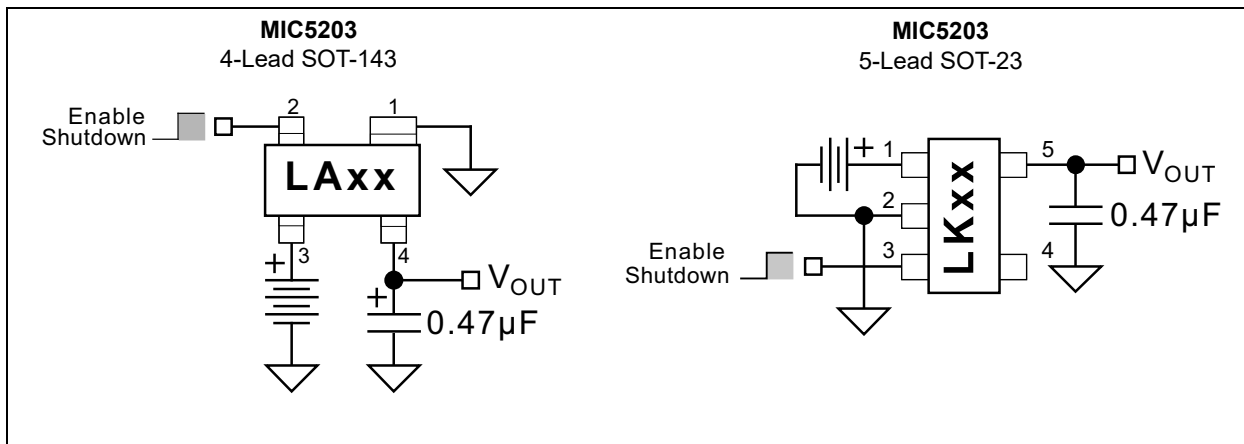
The MIC5203 is available in 2.8V, 3.0V, 3.3V, 3.6V, 3.8V, 4.0V, 4.5V, 4.75V, and 5.0V fixed voltages. Other voltages are available.

### Package Types



# MIC5203

## Typical Application Circuits



## 1.0 ELECTRICAL CHARACTERISTICS

### Absolute Maximum Ratings †

Supply Input Voltage ( $V_{IN}$ )	.....	-20V to +20V
Enable Input Voltage ( $V_{EN}$ )	.....	-20V to +20V
Power Dissipation ( $P_D$ ) (Note 1)	.....	Internally Limited

### Operating Ratings ‡

Supply Input Voltage ( $V_{IN}$ )	.....	+2.5V to +16V
Enable Input Voltage ( $V_{EN}$ )	.....	0V to $V_{IN}$

† **Notice:** Stresses above those listed under “Absolute Maximum Ratings” may cause permanent damage to the device. This is a stress rating only and functional operation of the device at those or any other conditions above those indicated in the operational sections of this specification is not intended. Exposure to maximum rating conditions for extended periods may affect device reliability.

‡ **Notice:** The device is not guaranteed to function outside its operating ratings.

**Note 1:** The maximum allowable power dissipation at any  $T_A$  (ambient temperature) is  $P_{D(MAX)} = (T_{J(MAX)} - T_A)/\theta_{JA}$ . Exceeding the maximum allowable power dissipation will result in excessive die temperature, and the regulator will go into thermal shutdown. The  $\theta_{JA}$  of the MIC5205-xxYM5 (all versions) is 220°C/W mounted on a PC board.

## ELECTRICAL CHARACTERISTICS

**Electrical Characteristics:**  $V_{IN} = V_{OUT} + 1V$ ;  $I_L = 1\text{ mA}$ ;  $C_L = 0.47\ \mu\text{F}$ ;  $V_{EN} \geq 2.0V$ ;  $T_J = +25^\circ\text{C}$ , **bold** values indicate  $-40^\circ\text{C} < T_J \leq +125^\circ\text{C}$ , unless noted.

Parameter	Symbol	Min.	Typ.	Max.	Units	Conditions
Output Voltage Accuracy	$V_O$	-3	—	3	%	—
		<b>-4</b>	—	<b>4</b>		
Output Voltage Temperature Coefficient	$\Delta V_O/\Delta T$	—	50	<b>200</b>	ppm/°C	Note 1
Line Regulation	$\Delta V_O/V_O$	—	0.008	0.3	%	$V_{IN} = V_{OUT} + 1V$ to 16V
		—	—	<b>0.5</b>		
Load Regulation	$\Delta V_O/V_O$	—	0.08	0.3	%	$I_L = 0.1\text{ mA}$ to 80 mA, Note 2
		—	—	0.5		
Dropout Voltage, Note 3	$\Delta V_O/V_O$	—	20	—	mV	$I_L = 100\ \mu\text{A}$
		—	200	<b>350</b>		$I_L = 20\text{ mA}$
		—	250	—		$I_L = 50\text{ mA}$
		—	300	<b>600</b>		$I_L = 80\text{ mA}$
Quiescent Current	$I_Q$	—	0.01	10	$\mu\text{A}$	$V_{EN} \leq 0.4V$ (shutdown)
Ground Pin Current, Note 4	$I_{GND}$	—	180	—	$\mu\text{A}$	$I_L = 100\ \mu\text{A}$ , $V_{EN} \geq 2.0V$ (active)
		—	225	<b>750</b>		$I_L = 20\text{ mA}$ , $V_{EN} \geq 2.0V$ (active)
		—	850	—		$I_L = 50\text{ mA}$ , $V_{EN} \geq 2.0V$ (active)
		—	1800	<b>3000</b>		$I_L = 80\text{ mA}$ , $V_{EN} \geq 2.0V$ (active)
Ground Pin Current at Dropout	$I_{GNDDO}$	—	200	<b>300</b>	$\mu\text{A}$	$V_{IN} = V_{OUT(nom)} - 0.5V$ , Note 4
Current Limit	$I_{LIMIT}$	—	180	<b>250</b>	mA	$V_{OUT} = 0V$
Thermal Regulation	$\Delta V_O/\Delta P_D$	—	0.05	—	%/W	Note 5

# MIC5203

## ELECTRICAL CHARACTERISTICS (CONTINUED)

**Electrical Characteristics:**  $V_{IN} = V_{OUT} + 1V$ ;  $I_L = 1 \text{ mA}$ ;  $C_L = 0.47 \mu\text{F}$ ;  $V_{EN} \geq 2.0V$ ;  $T_J = +25^\circ\text{C}$ , **bold** values indicate  $-40^\circ\text{C} < T_J \leq +125^\circ\text{C}$ , unless noted.

Parameter	Symbol	Min.	Typ.	Max.	Units	Conditions
<b>ENABLE Input</b>						
Enable Input Voltage Level	$V_{IL}$	—	—	<b>0.6</b>	V	Logic low (off)
		2.0	—	—		Logic low (on)
Enable Input Current	$I_{IL}$	—	0.01	1	$\mu\text{A}$	$V_{IL} \leq 0.6V$
	$I_{IH}$	—	15	<b>50</b>		$V_{IH} \geq 2.0V$

- Note 1:** Output voltage temperature coefficient is defined as the worst case voltage change divided by the total temperature range.
- 2:** Regulation is measured at constant junction temperature using low duty cycle pulse testing. Parts are tested for load regulation in the load range from 0.1 mA to 150 mA. Changes in output voltage due to heating effects are covered by the thermal regulation specification.
- 3:** Dropout Voltage is defined as the input to output differential at which the output voltage drops 2% below its nominal value measured at 1V differential.
- 4:** Ground pin current is the regulator quiescent current plus pass transistor base current. The total current drawn from the supply is the sum of the load current plus the ground pin current.
- 5:** Thermal regulation is defined as the change in output voltage at a time “t” after a change in power dissipation is applied, excluding load or line regulation effects. Specifications are for a 150 mA load pulse at  $V_{IN} = 16V$  for  $t = 10 \text{ ms}$ .

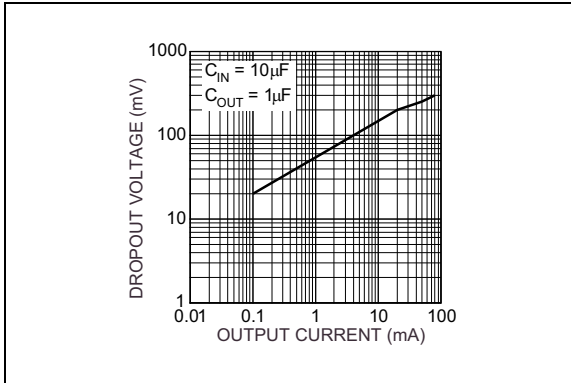
## TEMPERATURE SPECIFICATIONS (Note 1)

Parameters	Symbol	Min.	Typ.	Max.	Units	Conditions
<b>Temperature Ranges</b>						
Junction Temperature Range	$T_J$	-40	—	+125	$^\circ\text{C}$	—
Storage Temperature Range	$T_S$	-60	—	+150	$^\circ\text{C}$	—
Lead Temperature	—	—	—	+260	$^\circ\text{C}$	Soldering, 5s
<b>Package Thermal Resistances</b>						
Thermal Resistance SOT-143	$\theta_{JA}$	—	250	—	$^\circ\text{C}/\text{W}$	Note 2
Thermal Resistance SOT-23-5		—	220	—	$^\circ\text{C}/\text{W}$	

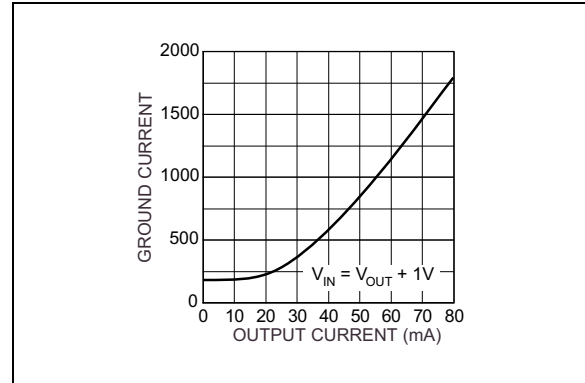
- Note 1:** The maximum allowable power dissipation is a function of ambient temperature, the maximum allowable junction temperature and the thermal resistance from junction to air (i.e.,  $T_A$ ,  $T_J$ ,  $\theta_{JA}$ ). Exceeding the maximum allowable power dissipation will cause the device operating junction temperature to exceed the maximum +125 $^\circ\text{C}$  rating. Sustained junction temperatures above +125 $^\circ\text{C}$  can impact the device reliability.
- 2:** The maximum allowable power dissipation at any  $T_A$  (ambient temperature) is  $P_{D(\text{max})} = (T_{J(\text{max})} - T_A)/\theta_{JA}$ . Exceeding the maximum allowable power dissipation will result in excessive die temperature, and the regulator will go into thermal shutdown.

## 2.0 TYPICAL PERFORMANCE CURVES

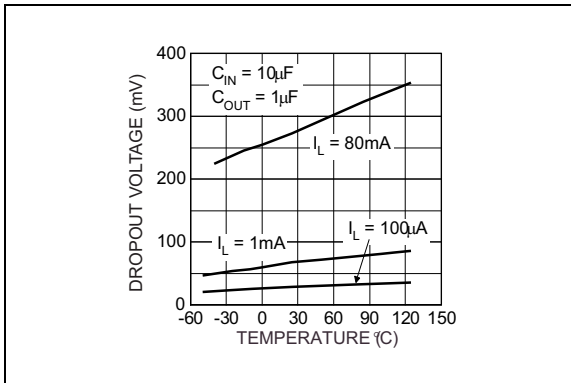
**Note:** The graphs and tables provided following this note are a statistical summary based on a limited number of samples and are provided for informational purposes only. The performance characteristics listed herein are not tested or guaranteed. In some graphs or tables, the data presented may be outside the specified operating range (e.g., outside specified power supply range) and therefore outside the warranted range.



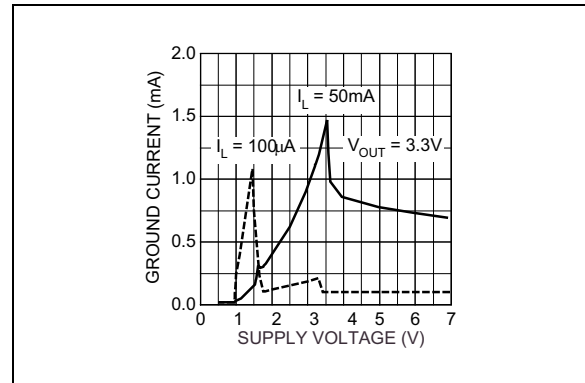
**FIGURE 2-1:** Dropout Voltage vs. Output Current.



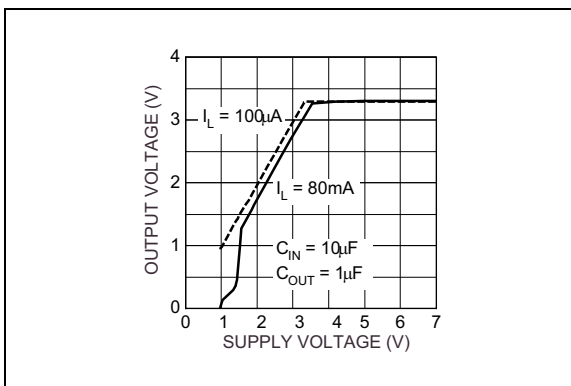
**FIGURE 2-4:** Ground Current vs. Output Current.



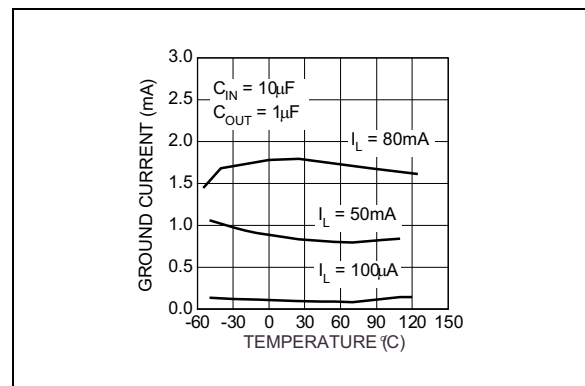
**FIGURE 2-2:** Dropout Voltage vs. Temperature.



**FIGURE 2-5:** Ground Current vs. Supply Voltage.

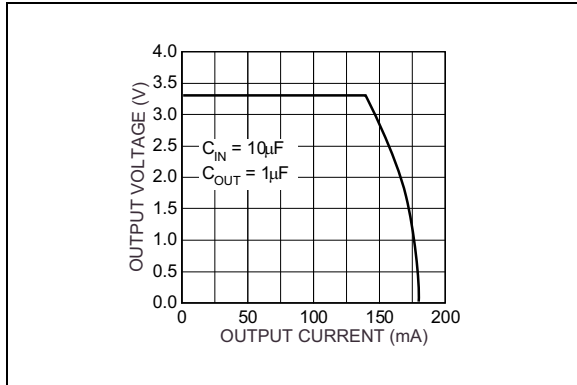


**FIGURE 2-3:** Dropout Characteristics.

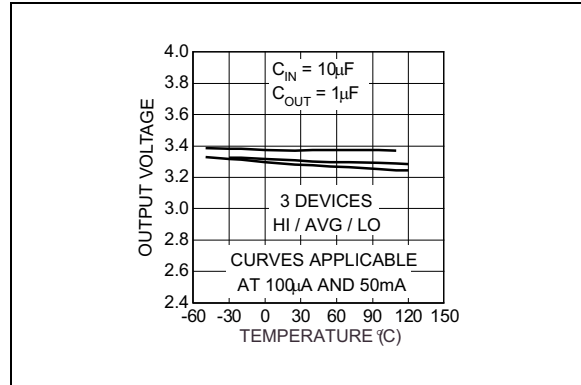


**FIGURE 2-6:** Ground Current vs. Temperature.

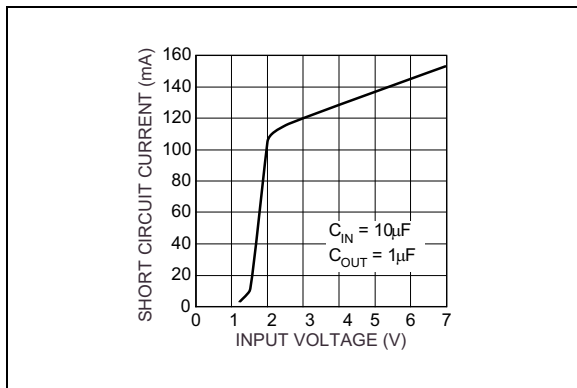
# MIC5203



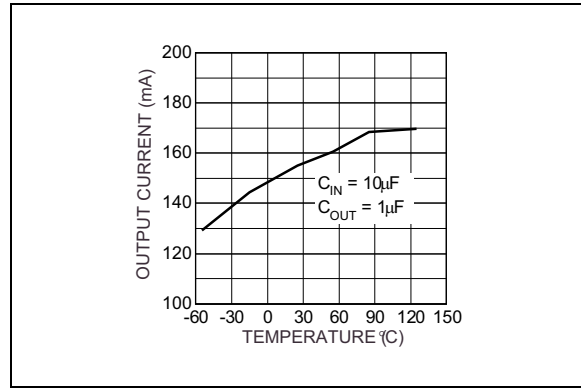
**FIGURE 2-7:** Output Voltage vs. Output Current.



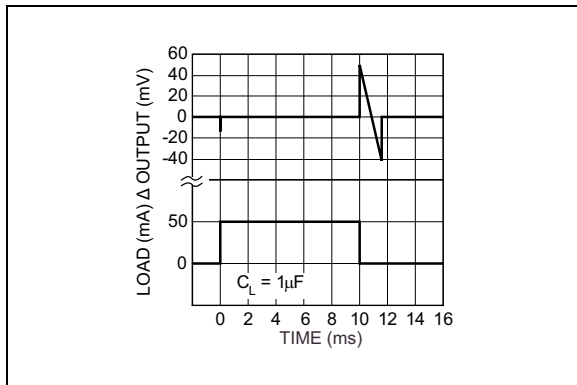
**FIGURE 2-10:** Output Voltage vs. Temperature.



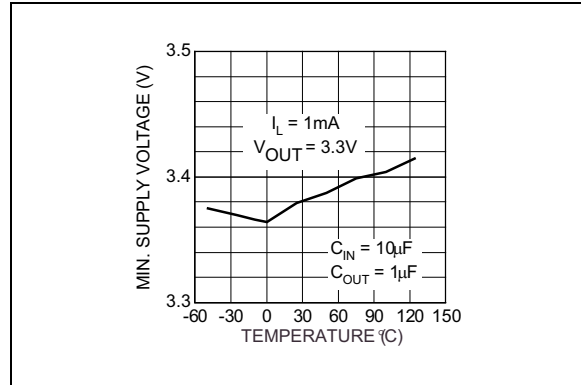
**FIGURE 2-8:** Short Circuit vs. Input Voltage.



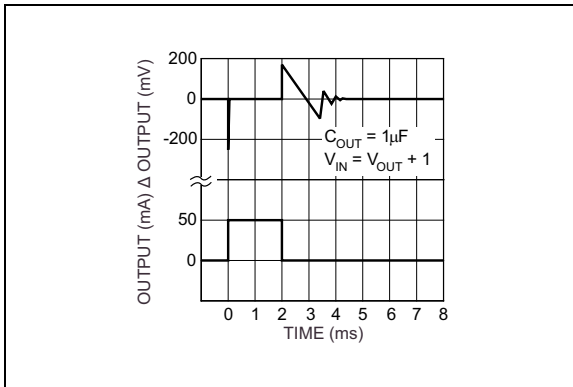
**FIGURE 2-11:** Short Circuit Current vs. Temperature.



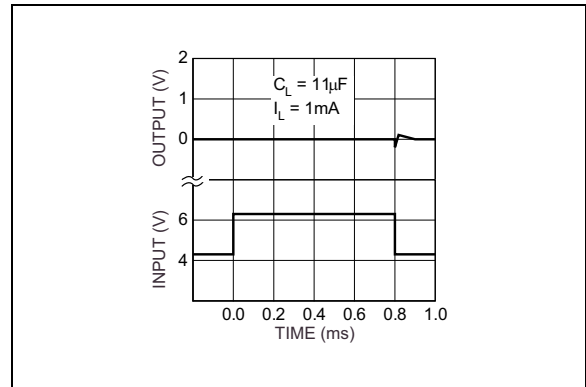
**FIGURE 2-9:** Thermal Regulation (3.3V Version).



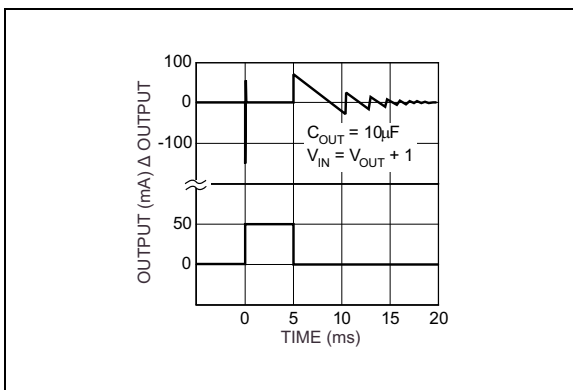
**FIGURE 2-12:** Minimum Supply Voltage vs. Temperature.



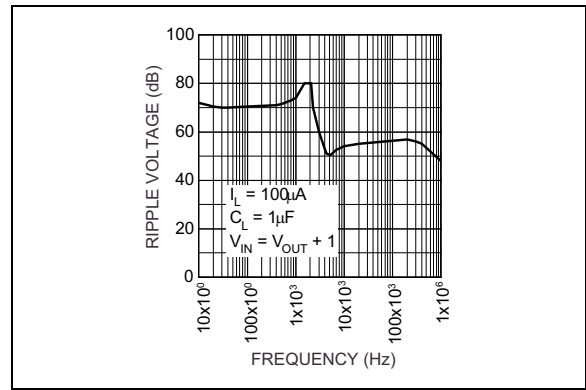
**FIGURE 2-13:** Load Transient.



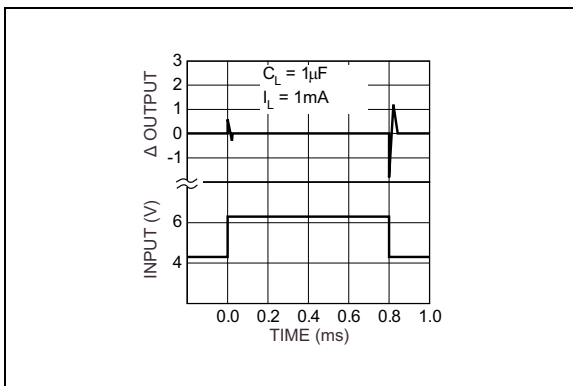
**FIGURE 2-16:** Line Transient.



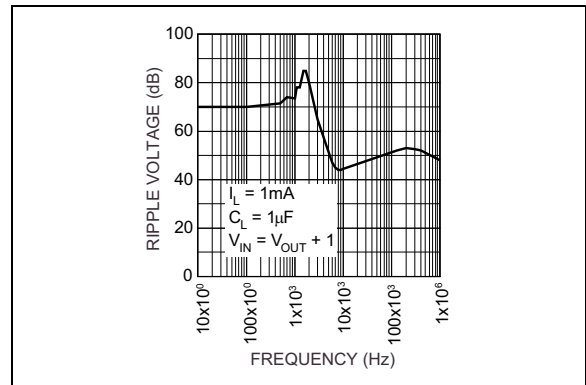
**FIGURE 2-14:** Load Transient.



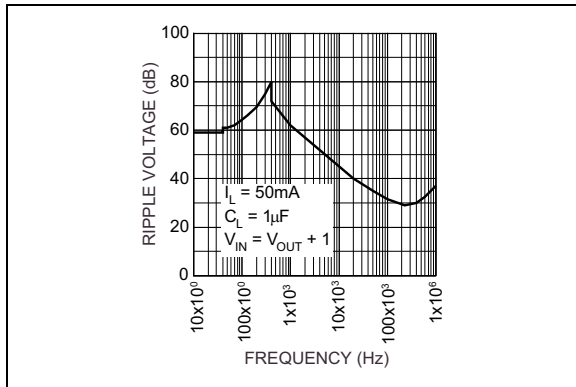
**FIGURE 2-17:** Ripple Voltage vs. Frequency.



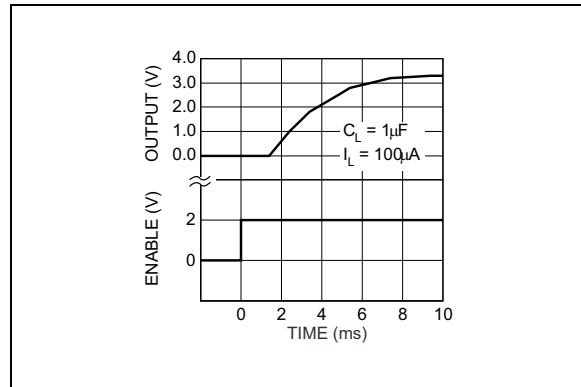
**FIGURE 2-15:** Line Transient.



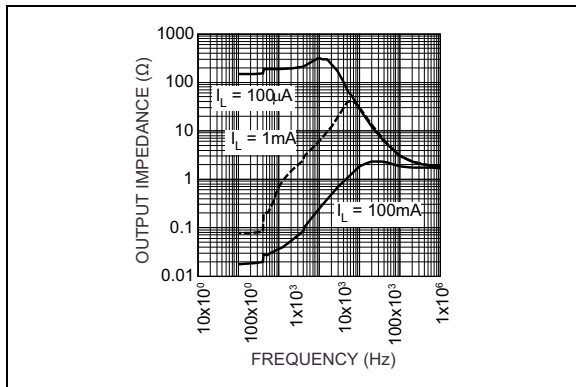
**FIGURE 2-18:** Ripple Voltage vs. Frequency.



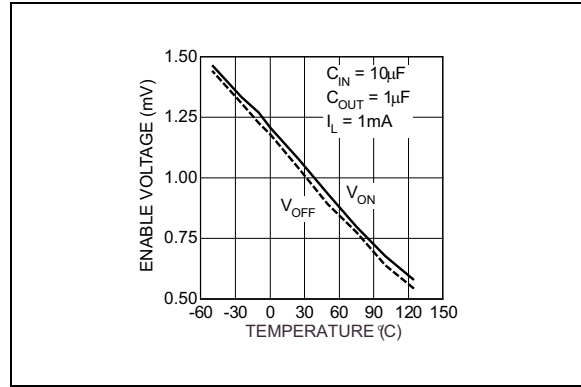
**FIGURE 2-19:** *Ripple Voltage vs. Frequency.*



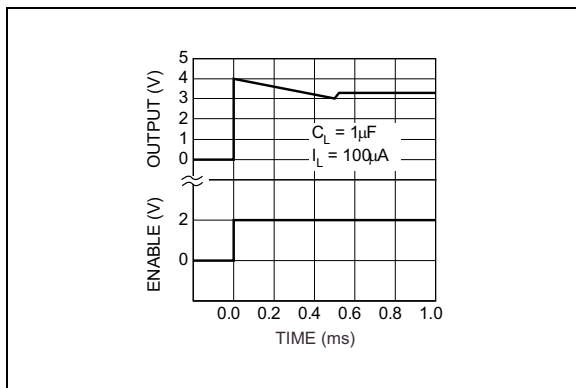
**FIGURE 2-22:** *Enable Characteristics (3.3 Version).*



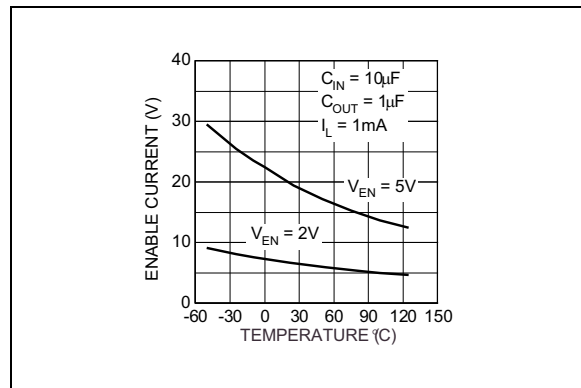
**FIGURE 2-20:** *Output Impedance.*



**FIGURE 2-23:** *Enable Voltage vs. Temperature.*



**FIGURE 2-21:** *Enable Characteristics (3.3 Version).*



**FIGURE 2-24:** *Enable Current vs. Temperature.*



## 3.0 PIN DESCRIPTIONS

The descriptions of the pins are listed in [Table 3-1](#).

**TABLE 3-1: PIN FUNCTION TABLE**

Pin Number SOT-143	Pin Number SOT-23-5	Pin Name	Description
1	2	GND	Ground
2	3	EN	Enable (Input): TTL/CMOS compatible control input. Logic high = enabled; logic low or open = shutdown
3	1	IN	Supply input
—	4	NC	Not internally connected
4	5	OUT	Regulator output

# MIC5203

---

---

## 4.0 APPLICATION INFORMATION

### 4.1 Input Capacitor

A 0.1  $\mu\text{F}$  capacitor should be placed from IN to GND if there are more than 10 inches of wire between the input and the AC filter capacitor or if a battery is used as the input.

### 4.2 Output Capacitor

Typical PNP based regulators require an output capacitor to prevent oscillation. The MIC5203 is ultra-stable, requiring only 0.47  $\mu\text{F}$  of output capacitance for stability. The regulator is stable with all types of capacitors, including the tiny, low-ESR ceramic chip capacitors. The output capacitor value can be increased without limit to improve transient response.

The capacitor should have a resonant frequency above 500 kHz. Ceramic capacitors work, but some dielectrics have poor temperature coefficients, which will affect the value of the output capacitor over temperature. Tantalum capacitors are much more stable over temperature, but typically are larger and more expensive. Aluminum electrolytic capacitors will also work, but they have electrolytes that freeze at about  $-30^{\circ}\text{C}$ . Tantalum or ceramic capacitors are recommended for operation below  $-25^{\circ}\text{C}$ .

### 4.3 No-Load Stability

The MIC5203 will remain stable and in regulation with no load (other than the internal voltage divider) unlike many other voltage regulators. This is especially important in CMOS RAM keep-alive applications.

### 4.4 Enable Input

The MIC5203 features nearly zero off-mode current. When EN (enable input) is held below 0.6V, all internal circuitry is powered off. Pulling EN high (over 2.0V) re-enables the device and allows operation. EN draws a small amount of current, typically 15  $\mu\text{A}$ . While the logic threshold is TTL/CMOS compatible, EN may be pulled as high as 20V, independent of  $V_{\text{IN}}$ .

## 5.0 PACKAGING INFORMATION

### 5.1 Package Marking Information

4-Lead SOT-143\*

XXXX
NNN

Example

LA33
415

5-Lead SOT-23\*

XXXX
NNN

Example

LK45
415

**TABLE 5-1: MARKING CODES**

SOT-143 Part #	Marking	Voltage	SOT-23 Part #	Marking	Voltage
MIC5203-2.6YM4	LA26	2.6V	MIC5203-2.6YM5	LK26	2.6V
MIC5203-2.8YM4	LA28	2.8V	MIC5203-2.8YM5	LK28	2.8V
MIC5203-3.0YM4	LA30	3.0V	MIC5203-3.0YM5	LK30	3.0V
MIC5203-3.3YM4	LA33	3.3V	MIC5203-3.3YM5	LK33	3.3V
MIC5203-3.6YM4	LA36	3.6V	MIC5203-3.6YM5	LK36	3.6V
MIC5203-3.8YM4	LA38	3.8V	MIC5203-3.8YM5	LK38	3.8V
MIC5203-4.0YM4	LA40	4.0V	MIC5203-4.0YM5	LK40	4.0V
MIC5203-4.5YM4	LA45	4.5V	MIC5203-4.5YM5	LK45	4.5V
MIC5203-4.7YM4	LA47	4.7V	MIC5203-4.7YM5	LK47	4.7V
MIC5203-5.0YM4	LA50	5.0V	MIC5203-5.0YM5	LK50	5.0V

<p><b>Legend:</b> XX...X Product code or customer-specific information          Y Year code (last digit of calendar year)          YY Year code (last 2 digits of calendar year)          WW Week code (week of January 1 is week '01')          NNN Alphanumeric traceability code          (e3) Pb-free JEDEC® designator for Matte Tin (Sn)          * This package is Pb-free. The Pb-free JEDEC designator (e3) can be found on the outer packaging for this package.          •, ▲, ▼ Pin one index is identified by a dot, delta up, or delta down (triangle mark).</p> <p><b>Note:</b> In the event the full Microchip part number cannot be marked on one line, it will be carried over to the next line, thus limiting the number of available characters for customer-specific information. Package may or may not include the corporate logo.          Underbar ( ) and/or Overbar ( ) symbol may not be to scale.</p>
--

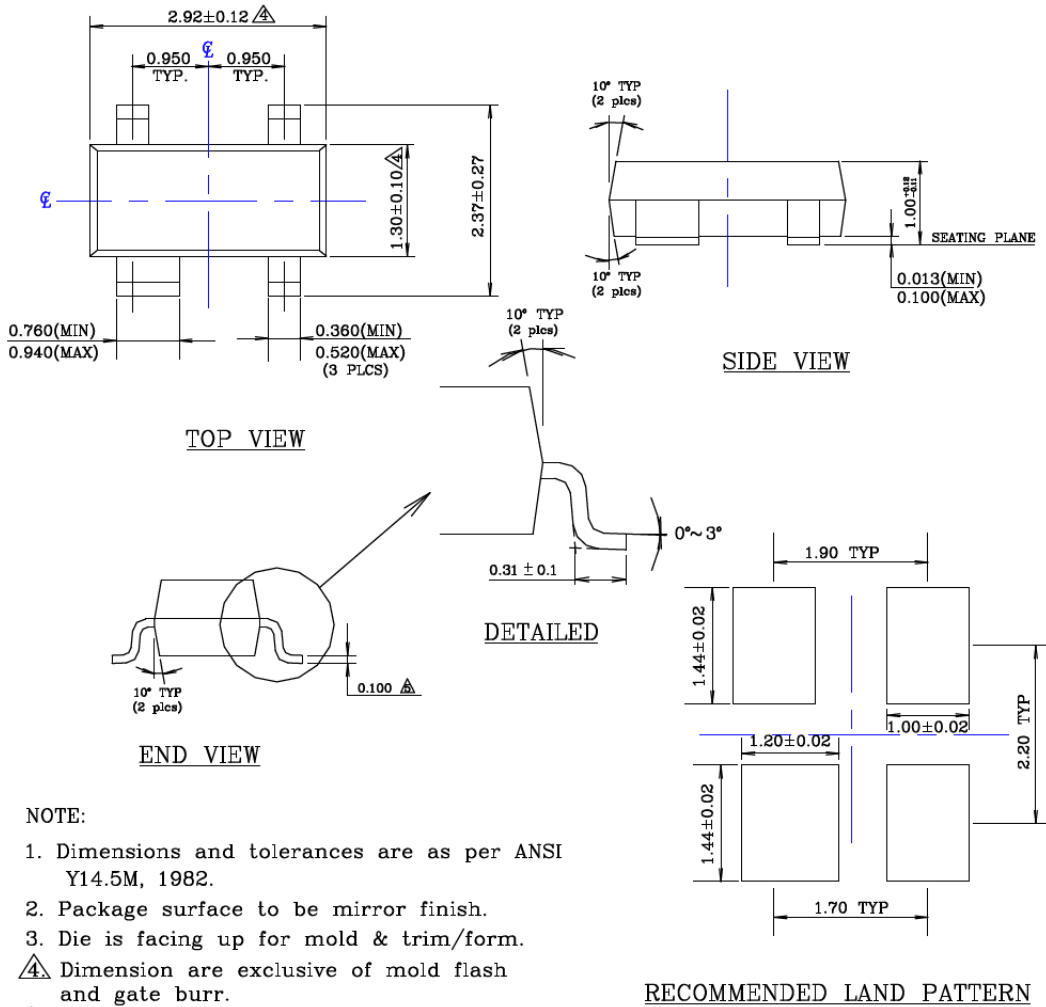
# MIC5203

## 4-Lead SOT-143 Package Outline and Recommended Land Pattern

**TITLE**

4 LEAD SOT143 PACKAGE OUTLINE & RECOMMENDED LAND PATTERN

DRAWING #	SOT143-4LD-PL-1	UNIT	MM
-----------	-----------------	------	----



**NOTE:**

1. Dimensions and tolerances are as per ANSI Y14.5M, 1982.
2. Package surface to be mirror finish.
3. Die is facing up for mold & trim/form.
4. Dimension are exclusive of mold flash and gate burr.
5. Dimension are exclusive of solder plating.

Note: For the most current package drawings, please see the Microchip Packaging Specification located at <http://www.microchip.com/packaging>.

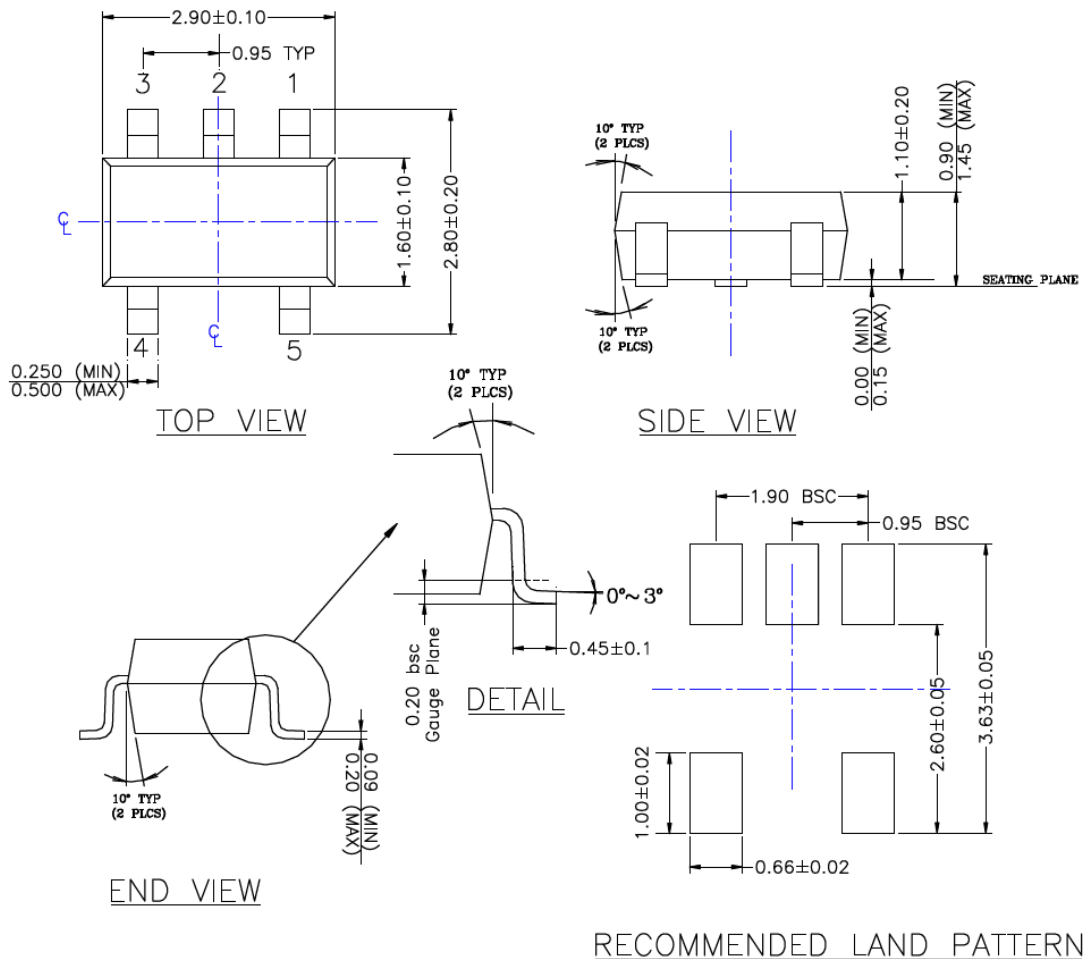
## 5-Lead SOT-23 Package Outline and Recommended Land Pattern

**TITLE**

5 LEAD SOT23 PACKAGE OUTLINE & RECOMMENDED LAND PATTERN

**DRAWING #** SOT23-5LD-PL-1

**UNIT** MM



**NOTE:**

1. PACKAGE OUTLINE EXCLUSIVE OF MOLD FLASH & BURR.
2. PACKAGE OUTLINE INCLUSIVE OF SOLER PLATING.
3. DIMENSION AND TOLERANCE PER ANSI Y14.5M, 1982.
4. FOOT LENGTH MEASUREMENT BASED ON GAUGE PLANE METHOD.
5. DIE FACES UP FOR MOLD, AND FACES DOWN FOR TRIM/FORM.
6. ALL DIMENSIONS ARE IN MILLIMETERS.

Note: For the most current package drawings, please see the Microchip Packaging Specification located at <http://www.microchip.com/packaging>.

# MIC5203

---

---

NOTES:

## APPENDIX A: REVISION HISTORY

### Revision A (November 2021)

- Converted Micrel document MIC5203 to Microchip data sheet DS20006609A.
- Minor text changes throughout.

# MIC5203

---

---

NOTES:



## PRODUCT IDENTIFICATION SYSTEM

To order or obtain information, e.g., on pricing or delivery, contact your local Microchip representative or sales office.

<u>PART NO.</u>	<u>-X.X</u>	<u>X</u>	<u>XX</u>	<u>-XX</u>
Device	Voltage	Temperature	Package	Media Type
<b>Device:</b>	MIC5203:	μCap 80 mA LDO Regulator		
<b>Voltage:</b>	2.8 = 2.8V			
	3.0 = 3.0V			
	3.3 = 3.3V			
	3.6 = 3.6V			
	3.8 = 3.8V			
	4.0 = 4.0V			
	4.5 = 4.5V			
	4.75 = 4.75V			
	5.0 = 5.0V			
<b>Temperature:</b>	Y = -40°C to +125°C			
<b>Package:</b>	M4 = 4-Lead SOT-143			
	M5 = 5-Lead SOT-23			
<b>Media Type:</b>	TR = 3,000/Reel			

### Examples:

- a) MIC5203-2.8YM4-TR      MIC5203, μCap 80 mA LDO Regulator, -40°C to +125°C, Temperature Range, 4-Lead SOT-143, 3,000/Reel
- b) MIC5203-5.0YM5-TR      MIC5203, μCap 80 mA LDO Regulator, -40°C to +125°C, Temperature Range, 5-Lead SOT-23-5, 3,000/Reel

**Note 1:** Tape and Reel identifier only appears in the catalog part number description. This identifier is used for ordering purposes and is not printed on the device package. Check with your Microchip Sales Office for package availability with the Tape and Reel option.

# MIC5203

---

---

NOTES:

---

---

**Note the following details of the code protection feature on Microchip products:**

- Microchip products meet the specifications contained in their particular Microchip Data Sheet.
- Microchip believes that its family of products is secure when used in the intended manner, within operating specifications, and under normal conditions.
- Microchip values and aggressively protects its intellectual property rights. Attempts to breach the code protection features of Microchip product is strictly prohibited and may violate the Digital Millennium Copyright Act.
- Neither Microchip nor any other semiconductor manufacturer can guarantee the security of its code. Code protection does not mean that we are guaranteeing the product is “unbreakable”. Code protection is constantly evolving. Microchip is committed to continuously improving the code protection features of our products.

---

This publication and the information herein may be used only with Microchip products, including to design, test, and integrate Microchip products with your application. Use of this information in any other manner violates these terms. Information regarding device applications is provided only for your convenience and may be superseded by updates. It is your responsibility to ensure that your application meets with your specifications. Contact your local Microchip sales office for additional support or, obtain additional support at <https://www.microchip.com/en-us/support/design-help/client-support-services>.

THIS INFORMATION IS PROVIDED BY MICROCHIP "AS IS". MICROCHIP MAKES NO REPRESENTATIONS OR WARRANTIES OF ANY KIND WHETHER EXPRESS OR IMPLIED, WRITTEN OR ORAL, STATUTORY OR OTHERWISE, RELATED TO THE INFORMATION INCLUDING BUT NOT LIMITED TO ANY IMPLIED WARRANTIES OF NON-INFRINGEMENT, MERCHANTABILITY, AND FITNESS FOR A PARTICULAR PURPOSE, OR WARRANTIES RELATED TO ITS CONDITION, QUALITY, OR PERFORMANCE.

IN NO EVENT WILL MICROCHIP BE LIABLE FOR ANY INDIRECT, SPECIAL, PUNITIVE, INCIDENTAL, OR CONSEQUENTIAL LOSS, DAMAGE, COST, OR EXPENSE OF ANY KIND WHATSOEVER RELATED TO THE INFORMATION OR ITS USE, HOWEVER CAUSED, EVEN IF MICROCHIP HAS BEEN ADVISED OF THE POSSIBILITY OR THE DAMAGES ARE FORESEEABLE. TO THE FULLEST EXTENT ALLOWED BY LAW, MICROCHIP'S TOTAL LIABILITY ON ALL CLAIMS IN ANY WAY RELATED TO THE INFORMATION OR ITS USE WILL NOT EXCEED THE AMOUNT OF FEES, IF ANY, THAT YOU HAVE PAID DIRECTLY TO MICROCHIP FOR THE INFORMATION.

Use of Microchip devices in life support and/or safety applications is entirely at the buyer's risk, and the buyer agrees to defend, indemnify and hold harmless Microchip from any and all damages, claims, suits, or expenses resulting from such use. No licenses are conveyed, implicitly or otherwise, under any Microchip intellectual property rights unless otherwise stated.

For information regarding Microchip's Quality Management Systems, please visit [www.microchip.com/quality](http://www.microchip.com/quality).

**Trademarks**

The Microchip name and logo, the Microchip logo, Adaptec, AnyRate, AVR, AVR logo, AVR Freaks, BesTime, BitCloud, CryptoMemory, CryptoRF, dsPIC, flexPWR, HELDO, IGLOO, JukeBlox, KeeLoq, Kleer, LANCheck, LinkMD, maXStylus, maXTouch, MediaLB, megaAVR, Microsemi, Microsemi logo, MOST, MOST logo, MPLAB, OptoLyzer, PIC, picoPower, PICSTART, PIC32 logo, PolarFire, Prochip Designer, QTouch, SAM-BA, SenGenuity, SpyNIC, SST, SST Logo, SuperFlash, Symmetricom, SyncServer, Tachyon, TimeSource, tinyAVR, UNI/O, Vectron, and XMEGA are registered trademarks of Microchip Technology Incorporated in the U.S.A. and other countries.

AgileSwitch, APT, ClockWorks, The Embedded Control Solutions Company, EtherSynch, Flashtec, Hyper Speed Control, HyperLight Load, IntelliMOS, Libero, motorBench, mTouch, Powermite 3, Precision Edge, ProASIC, ProASIC Plus, ProASIC Plus logo, QuietWire, SmartFusion, SyncWorld, Temux, TimeCesium, TimeHub, TimePictra, TimeProvider, TrueTime, WinPath, and ZL are registered trademarks of Microchip Technology Incorporated in the U.S.A.

Adjacent Key Suppression, AKS, Analog-for-the-Digital Age, Any Capacitor, AnyIn, AnyOut, Augmented Switching, BlueSky, BodyCom, CodeGuard, CryptoAuthentication, CryptoAutomotive, CryptoCompanion, CryptoController, dsPICDEM, dsPICDEM.net, Dynamic Average Matching, DAM, ECAN, Espresso T1S, EtherGREEN, GridTime, IdealBridge, In-Circuit Serial Programming, ICSP, INICnet, Intelligent Paralleling, Inter-Chip Connectivity, JitterBlocker, Knob-on-Display, maxCrypto, maxView, memBrain, Mindi, MiWi, MPASM, MPF, MPLAB Certified logo, MPLIB, MPLINK, MultiTRAK, NetDetach, NVM Express, NVMe, Omniscient Code Generation, PICDEM, PICDEM.net, PICkit, PICtail, PowerSmart, PureSilicon, QMatrix, REAL ICE, Ripple Blocker, RTAX, RTG4, SAM-ICE, Serial Quad I/O, simpleMAP, SimpliPHY, SmartBuffer, SmartHLS, SMART-I.S., storClad, SQI, SuperSwitcher, SuperSwitcher II, Switchtec, SynchroPHY, Total Endurance, TSHARC, USBCheck, VariSense, VectorBlox, VeriPHY, ViewSpan, WiperLock, XpressConnect, and ZENA are trademarks of Microchip Technology Incorporated in the U.S.A. and other countries.

SQTP is a service mark of Microchip Technology Incorporated in the U.S.A.

The Adaptec logo, Frequency on Demand, Silicon Storage Technology, Symmcom, and Trusted Time are registered trademarks of Microchip Technology Inc. in other countries.

GestIC is a registered trademark of Microchip Technology Germany II GmbH & Co. KG, a subsidiary of Microchip Technology Inc., in other countries.

All other trademarks mentioned herein are property of their respective companies.

© 2021, Microchip Technology Incorporated and its subsidiaries.

All Rights Reserved.

ISBN: 978-1-5224-9289-4



# MICROCHIP

## Worldwide Sales and Service

### AMERICAS

**Corporate Office**  
2355 West Chandler Blvd.  
Chandler, AZ 85224-6199  
Tel: 480-792-7200  
Fax: 480-792-7277  
Technical Support:  
[http://www.microchip.com/  
support](http://www.microchip.com/support)  
Web Address:  
[www.microchip.com](http://www.microchip.com)

#### Atlanta

Duluth, GA  
Tel: 678-957-9614  
Fax: 678-957-1455

#### Austin, TX

Tel: 512-257-3370

#### Boston

Westborough, MA  
Tel: 774-760-0087  
Fax: 774-760-0088

#### Chicago

Itasca, IL  
Tel: 630-285-0071  
Fax: 630-285-0075

#### Dallas

Addison, TX  
Tel: 972-818-7423  
Fax: 972-818-2924

#### Detroit

Novi, MI  
Tel: 248-848-4000

#### Houston, TX

Tel: 281-894-5983

#### Indianapolis

Noblesville, IN  
Tel: 317-773-8323  
Fax: 317-773-5453  
Tel: 317-536-2380

#### Los Angeles

Mission Viejo, CA  
Tel: 949-462-9523  
Fax: 949-462-9608  
Tel: 951-273-7800

#### Raleigh, NC

Tel: 919-844-7510

#### New York, NY

Tel: 631-435-6000

#### San Jose, CA

Tel: 408-735-9110  
Tel: 408-436-4270

#### Canada - Toronto

Tel: 905-695-1980  
Fax: 905-695-2078

### ASIA/PACIFIC

**Australia - Sydney**  
Tel: 61-2-9868-6733

**China - Beijing**  
Tel: 86-10-8569-7000

**China - Chengdu**  
Tel: 86-28-8665-5511

**China - Chongqing**  
Tel: 86-23-8980-9588

**China - Dongguan**  
Tel: 86-769-8702-9880

**China - Guangzhou**  
Tel: 86-20-8755-8029

**China - Hangzhou**  
Tel: 86-571-8792-8115

**China - Hong Kong SAR**  
Tel: 852-2943-5100

**China - Nanjing**  
Tel: 86-25-8473-2460

**China - Qingdao**  
Tel: 86-532-8502-7355

**China - Shanghai**  
Tel: 86-21-3326-8000

**China - Shenyang**  
Tel: 86-24-2334-2829

**China - Shenzhen**  
Tel: 86-755-8864-2200

**China - Suzhou**  
Tel: 86-186-6233-1526

**China - Wuhan**  
Tel: 86-27-5980-5300

**China - Xian**  
Tel: 86-29-8833-7252

**China - Xiamen**  
Tel: 86-592-2388138

**China - Zhuhai**  
Tel: 86-756-3210040

### ASIA/PACIFIC

**India - Bangalore**  
Tel: 91-80-3090-4444

**India - New Delhi**  
Tel: 91-11-4160-8631

**India - Pune**  
Tel: 91-20-4121-0141

**Japan - Osaka**  
Tel: 81-6-6152-7160

**Japan - Tokyo**  
Tel: 81-3-6880-3770

**Korea - Daegu**  
Tel: 82-53-744-4301

**Korea - Seoul**  
Tel: 82-2-554-7200

**Malaysia - Kuala Lumpur**  
Tel: 60-3-7651-7906

**Malaysia - Penang**  
Tel: 60-4-227-8870

**Philippines - Manila**  
Tel: 63-2-634-9065

**Singapore**  
Tel: 65-6334-8870

**Taiwan - Hsin Chu**  
Tel: 886-3-577-8366

**Taiwan - Kaohsiung**  
Tel: 886-7-213-7830

**Taiwan - Taipei**  
Tel: 886-2-2508-8600

**Thailand - Bangkok**  
Tel: 66-2-694-1351

**Vietnam - Ho Chi Minh**  
Tel: 84-28-5448-2100

### EUROPE

**Austria - Wels**  
Tel: 43-7242-2244-39  
Fax: 43-7242-2244-393

**Denmark - Copenhagen**  
Tel: 45-4485-5910  
Fax: 45-4485-2829

**Finland - Espoo**  
Tel: 358-9-4520-820

**France - Paris**  
Tel: 33-1-69-53-63-20  
Fax: 33-1-69-30-90-79

**Germany - Garching**  
Tel: 49-8931-9700

**Germany - Haan**  
Tel: 49-2129-3766400

**Germany - Heilbronn**  
Tel: 49-7131-72400

**Germany - Karlsruhe**  
Tel: 49-721-625370

**Germany - Munich**  
Tel: 49-89-627-144-0  
Fax: 49-89-627-144-44

**Germany - Rosenheim**  
Tel: 49-8031-354-560

**Israel - Ra'anana**  
Tel: 972-9-744-7705

**Italy - Milan**  
Tel: 39-0331-742611  
Fax: 39-0331-466781

**Italy - Padova**  
Tel: 39-049-7625286

**Netherlands - Drunen**  
Tel: 31-416-690399  
Fax: 31-416-690340

**Norway - Trondheim**  
Tel: 47-7288-4388

**Poland - Warsaw**  
Tel: 48-22-3325737

**Romania - Bucharest**  
Tel: 40-21-407-87-50

**Spain - Madrid**  
Tel: 34-91-708-08-90  
Fax: 34-91-708-08-91

**Sweden - Gothenberg**  
Tel: 46-31-704-60-40

**Sweden - Stockholm**  
Tel: 46-8-5090-4654

**UK - Wokingham**  
Tel: 44-118-921-5800  
Fax: 44-118-921-5820