

To our customers,

Old Company Name in Catalogs and Other Documents

On April 1st, 2010, NEC Electronics Corporation merged with Renesas Technology Corporation, and Renesas Electronics Corporation took over all the business of both companies. Therefore, although the old company name remains in this document, it is a valid Renesas Electronics document. We appreciate your understanding.

Renesas Electronics website: <http://www.renesas.com>

April 1st, 2010
Renesas Electronics Corporation

Issued by: Renesas Electronics Corporation (<http://www.renesas.com>)

Send any inquiries to <http://www.renesas.com/inquiry>.

Notice

1. All information included in this document is current as of the date this document is issued. Such information, however, is subject to change without any prior notice. Before purchasing or using any Renesas Electronics products listed herein, please confirm the latest product information with a Renesas Electronics sales office. Also, please pay regular and careful attention to additional and different information to be disclosed by Renesas Electronics such as that disclosed through our website.
2. Renesas Electronics does not assume any liability for infringement of patents, copyrights, or other intellectual property rights of third parties by or arising from the use of Renesas Electronics products or technical information described in this document. No license, express, implied or otherwise, is granted hereby under any patents, copyrights or other intellectual property rights of Renesas Electronics or others.
3. You should not alter, modify, copy, or otherwise misappropriate any Renesas Electronics product, whether in whole or in part.
4. Descriptions of circuits, software and other related information in this document are provided only to illustrate the operation of semiconductor products and application examples. You are fully responsible for the incorporation of these circuits, software, and information in the design of your equipment. Renesas Electronics assumes no responsibility for any losses incurred by you or third parties arising from the use of these circuits, software, or information.
5. When exporting the products or technology described in this document, you should comply with the applicable export control laws and regulations and follow the procedures required by such laws and regulations. You should not use Renesas Electronics products or the technology described in this document for any purpose relating to military applications or use by the military, including but not limited to the development of weapons of mass destruction. Renesas Electronics products and technology may not be used for or incorporated into any products or systems whose manufacture, use, or sale is prohibited under any applicable domestic or foreign laws or regulations.
6. Renesas Electronics has used reasonable care in preparing the information included in this document, but Renesas Electronics does not warrant that such information is error free. Renesas Electronics assumes no liability whatsoever for any damages incurred by you resulting from errors in or omissions from the information included herein.
7. Renesas Electronics products are classified according to the following three quality grades: “Standard”, “High Quality”, and “Specific”. The recommended applications for each Renesas Electronics product depends on the product’s quality grade, as indicated below. You must check the quality grade of each Renesas Electronics product before using it in a particular application. You may not use any Renesas Electronics product for any application categorized as “Specific” without the prior written consent of Renesas Electronics. Further, you may not use any Renesas Electronics product for any application for which it is not intended without the prior written consent of Renesas Electronics. Renesas Electronics shall not be in any way liable for any damages or losses incurred by you or third parties arising from the use of any Renesas Electronics product for an application categorized as “Specific” or for which the product is not intended where you have failed to obtain the prior written consent of Renesas Electronics. The quality grade of each Renesas Electronics product is “Standard” unless otherwise expressly specified in a Renesas Electronics data sheets or data books, etc.
 - “Standard”: Computers; office equipment; communications equipment; test and measurement equipment; audio and visual equipment; home electronic appliances; machine tools; personal electronic equipment; and industrial robots.
 - “High Quality”: Transportation equipment (automobiles, trains, ships, etc.); traffic control systems; anti-disaster systems; anti-crime systems; safety equipment; and medical equipment not specifically designed for life support.
 - “Specific”: Aircraft; aerospace equipment; submersible repeaters; nuclear reactor control systems; medical equipment or systems for life support (e.g. artificial life support devices or systems), surgical implantations, or healthcare intervention (e.g. excision, etc.), and any other applications or purposes that pose a direct threat to human life.
8. You should use the Renesas Electronics products described in this document within the range specified by Renesas Electronics, especially with respect to the maximum rating, operating supply voltage range, movement power voltage range, heat radiation characteristics, installation and other product characteristics. Renesas Electronics shall have no liability for malfunctions or damages arising out of the use of Renesas Electronics products beyond such specified ranges.
9. Although Renesas Electronics endeavors to improve the quality and reliability of its products, semiconductor products have specific characteristics such as the occurrence of failure at a certain rate and malfunctions under certain use conditions. Further, Renesas Electronics products are not subject to radiation resistance design. Please be sure to implement safety measures to guard them against the possibility of physical injury, and injury or damage caused by fire in the event of the failure of a Renesas Electronics product, such as safety design for hardware and software including but not limited to redundancy, fire control and malfunction prevention, appropriate treatment for aging degradation or any other appropriate measures. Because the evaluation of microcomputer software alone is very difficult, please evaluate the safety of the final products or system manufactured by you.
10. Please contact a Renesas Electronics sales office for details as to environmental matters such as the environmental compatibility of each Renesas Electronics product. Please use Renesas Electronics products in compliance with all applicable laws and regulations that regulate the inclusion or use of controlled substances, including without limitation, the EU RoHS Directive. Renesas Electronics assumes no liability for damages or losses occurring as a result of your noncompliance with applicable laws and regulations.
11. This document may not be reproduced or duplicated, in any form, in whole or in part, without prior written consent of Renesas Electronics.
12. Please contact a Renesas Electronics sales office if you have any questions regarding the information contained in this document or Renesas Electronics products, or if you have any other inquiries.

(Note 1) “Renesas Electronics” as used in this document means Renesas Electronics Corporation and also includes its majority-owned subsidiaries.

(Note 2) “Renesas Electronics product(s)” means any product developed or manufactured by or for Renesas Electronics.

BIPOLAR ANALOG INTEGRATED CIRCUIT

μ PC29S00 Series

LOW DROPOUT VOLTAGE REGULATOR WITH ON/OFF FUNCTION

DESCRIPTION

The μ PC29S00 series is a low dropout regulator, which has 100 mA capable for the output current. This series features ON/OFF function to control output voltage.

The μ PC29S00 series is suitable for NEC Electronics' single chip microcomputers, which have on-chip flash memory. The μ PC29S00 series is use of erasing and writing data on its flash memory.

FEATURES

- ON/OFF control function (active high)
- Output current excess of 100 mA
- ★ • Surface mount device package: 8-pin plastic SOP (5.72 mm (225)) (7.8 V output, 10 V output)
- High accuracy output voltage: $\pm 2\%$ (7.8 V output)
-2 to +1% (10 V output)
- On-chip all kinds of protection circuit

★ ORDERING INFORMATION

Part Number	Package	Output Voltage
μ PC29S78GR	8-pin plastic SOP (5.72 mm (225))	7.8 V
μ PC29S10GR	8-pin plastic SOP (5.72 mm (225))	10 V

PIN CONFIGURATION (Marking Side)

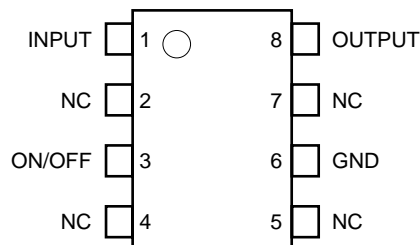

The information in this document is subject to change without notice. Before using this document, please confirm that this is the latest version.

Not all products and/or types are available in every country. Please check with an NEC Electronics sales representative for availability and additional information.

BLOCK DIAGRAM

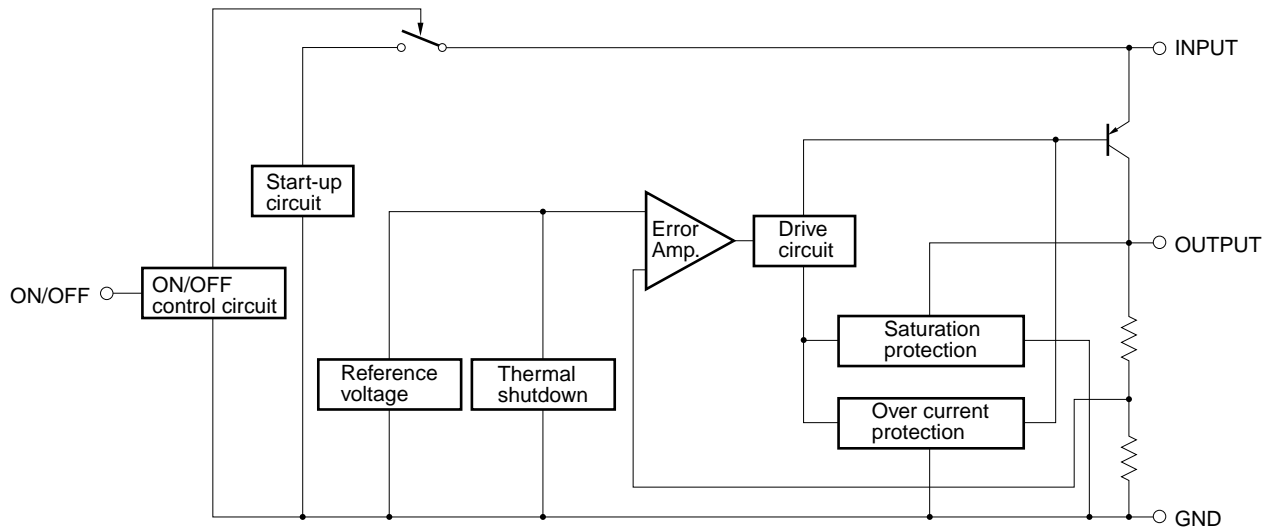

ABSOLUTE MAXIMUM RATINGS (T_A = 25°C, unless otherwise specified)

Parameter	Symbol	Rating	Unit
Input Voltage	V _{IN}	20	V
Internal Power Dissipation	P _T ^{Note}	0.48	W
Operating Ambient Temperature	T _A	-30 to +85	°C
Operating Junction Temperature	T _J	-30 to +150	°C
Storage Temperature	T _{stg}	-55 to +150	°C
Thermal Resistance (Junction to Ambient)	R _{th(J-A)}	260	°C/W

Note T_A ≤ 25°C, internally limited. When the operating junction temperature rises up to 150°C, the internal circuit shuts down the output voltage.

Caution Product quality may suffer if the absolute maximum rating is exceeded even momentarily for any parameter. That is, the absolute maximum ratings are rated values at which the product is on the verge of suffering physical damage, and therefore the product must be used under conditions that ensure that the absolute maximum ratings are not exceeded.

★ TYPICAL CONNECTION

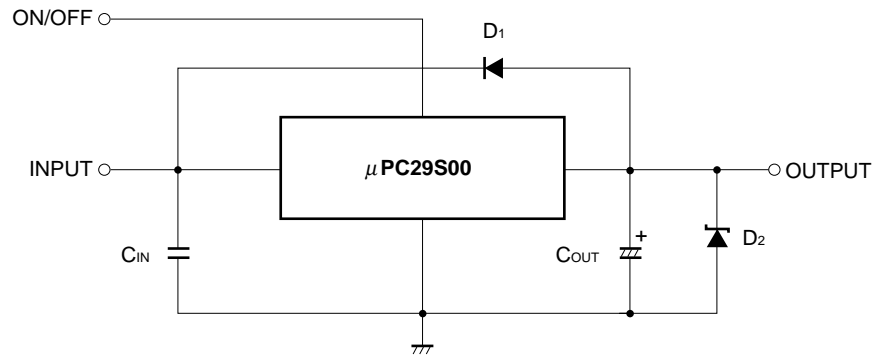

C_{IN}: 0.1 to 0.47 μF. Be sure to connect to prevent abnormal oscillation. For using capacitors, film capacitors whose voltage and temperature characteristics are excellent are recommended. Take care that some monolithic ceramic capacitor is inferior in the temperature and voltage characteristics. When using the monolithic ceramic capacitor, the C_{IN} needs to be held these capacities in voltage and temperature used.

C_{OUT}: 10 μF or higher. Be sure to connect to prevent oscillation and to improve the transient load stabilization.

Connect the C_{IN} and C_{OUT} as close as possible to the IC pins (within 2 cm).

D₁: Need for V_O > V_{IN}

D₂: Need a shottky barrier diode for V_O < GND

Cautions 1. When output is off (V_{ON/OFF} = low level), the OUTPUT pin should not be supplied higher voltage than V_{IN} voltage from external.

2. Design your circuit and mounting with consideration for heat radiation when using this device.

RECOMMENDED OPERATING CONDITIONS

Parameter	Symbol	Condition	MIN.	TYP.	MAX.	Unit
Input Voltage	V _{IN}	μPC29S78	8.8		18	V
		μPC29S10	11		18	V
Output Current	I _o		0		100	mA
Operating Ambient Temperature	T _A		-30		+85	°C
Operating Junction Temperature	T _J		-30		+125	°C

Caution If the Absolute Maximum Rating is not exceeded, there is no problem for using recommended operating range or more. Use and evaluate the μPC29S00 series since the leeway is decreased with the Absolute Maximum Rating. Moreover, the recommended operating range is not prescribed to use when all parameters are maximum value.

ELECTRICAL CHARACTERISTICS

μPC29S78 (T_J = 25°C, V_{IN} = 12 V, I_o = 50 mA, V_{ON/OFF} = 5 V, unless otherwise specified)

Parameter	Symbol	Conditions	MIN.	TYP.	MAX.	Unit
Output Voltage	V _o		7.64	7.8	7.96	V
		8.8 V ≤ V _{IN} ≤ 18 V, 0 mA ≤ I _o ≤ 50 mA, 0°C ≤ T _J ≤ +125°C	7.56		8.04	V
		0 mA ≤ I _o ≤ 100 mA, 0°C ≤ T _J ≤ +125°C	7.56		8.04	V
Line Regulation	REG _{IN}	8.8 V ≤ V _{IN} ≤ 18 V		22	75	mV
Load Regulation	REG _L	0 mA ≤ I _o ≤ 100 mA		21	75	mV
Quiescent Current	I _{BIAS}	I _o = 0 mA		3.0	5.0	mA
		I _o = 100 mA		11	25	mA
Startup Quiescent Current	I _{BIAS(S)1}	V _{IN} = 7.3 V, I _o = 0 mA		10	20	mA
	I _{BIAS(S)2}	V _{IN} = 7.3 V, I _o = 100 mA			50	mA
Quiescent Current Change	ΔI _{BIAS}	8.8 V ≤ V _{IN} ≤ 18 V, 0°C ≤ T _J ≤ +125°C			10	mA
Output Noise Voltage	V _n	10 Hz ≤ f ≤ 100 kHz		160		μVr.m.s.
Ripple Rejection	R•R	f = 120 Hz, 8.8 V ≤ V _{IN} ≤ 13.5 V	42	51		dB
Dropout Voltage	V _{DIF}	I _o = 100 mA, 0°C ≤ T _J ≤ +125°C			1.0	V
Peak Output Current	I _{opeak}	V _{IN} = 9.8 V	150	250	400	mA
Short Circuit Current	I _{oshort}	V _{IN} = 18 V		250		mA
Temperature Coefficient of Output Voltage	ΔV _o /ΔT	I _o = 5 mA, 0°C ≤ T _J ≤ +125°C		-0.4		mV/°C
ON/OFF Voltage	V _{ON/OFF1}	V _{IN} = 12 V, I _o = 10 mA		1.8	2.0	V
	V _{ON/OFF2}	V _{IN} = 12 V, I _o = 0 mA	0.8	1.6		V
ON/OFF Current	I _{ON/OFF1}	V _{ON/OFF} = 2.7 V, I _o = 0 mA		250	450	μA
	I _{ON/OFF2}	V _{ON/OFF} = 5 V, I _o = 0 mA		450	800	μA
Standby Current	I _{BIASOFF}	V _{ON/OFF} = 0 V, I _o = 0 mA			10	μA

μPC29S10 (T_J = 25°C, V_{IN} = 12 V, I_o = 50 mA, V_{ON/OFF} = 5 V, unless otherwise specified)

Parameter	Symbol	Conditions	MIN.	TYP.	MAX.	Unit
Output Voltage	V _o		9.80	10.00	10.10	V
		11 V ≤ V _{IN} ≤ 18 V, 0 mA ≤ I _o ≤ 50 mA, 0°C ≤ T _J ≤ +125°C	9.70		10.20	V
		0 mA ≤ I _o ≤ 100 mA, 0°C ≤ T _J ≤ +125°C	9.70		10.20	V
Line Regulation	REG _{IN}	11 V ≤ V _{IN} ≤ 18 V		27	100	mV
Load Regulation	REG _L	0 mA ≤ I _o ≤ 100 mA		18	100	mV
Quiescent Current	I _{BIAS}	I _o = 0 mA		3.3	5.0	mA
		I _o = 100 mA		12	25	mA
Startup Quiescent Current	I _{BIAS(S)1}	V _{IN} = 9.5 V, I _o = 0 mA		10	20	mA
	I _{BIAS(S)2}	V _{IN} = 9.5 V, I _o = 100 mA			50	mA
Quiescent Current Change	ΔI _{BIAS}	11 V ≤ V _{IN} ≤ 18 V, 0°C ≤ T _J ≤ +125°C		1.0	10	mA
Output Noise Voltage	V _n	10 Hz ≤ f ≤ 100 kHz		210		μVr.m.s.
Ripple Rejection	R•R	f = 120 Hz, 11 V ≤ V _{IN} ≤ 13.5 V	40	48		dB
Dropout Voltage	V _{DIF}	I _o = 100 mA, 0°C ≤ T _J ≤ +125°C		0.4	1.0	V
Peak Output Current	I _{opeak}	V _{IN} = 12 V	150	250	400	mA
Short Circuit Current	I _{oshort}	V _{IN} = 18 V		180		mA
Temperature Coefficient of Output Voltage	ΔV _o /ΔT	I _o = 5 mA, 0°C ≤ T _J ≤ +125°C		-0.5		mV/°C
ON/OFF Voltage	V _{ON/OFF1}	V _{IN} = 12 V, I _o = 10 mA		1.8	2.0	V
	V _{ON/OFF2}	V _{IN} = 12 V, I _o = 0 mA	0.8	1.6		V
ON/OFF Current	I _{ON/OFF1}	V _{ON/OFF} = 2.7 V, I _o = 0 mA		250	450	μA
	I _{ON/OFF2}	V _{ON/OFF} = 5 V, I _o = 0 mA		450	800	μA
Standby Current	I _{BIASOFF}	V _{ON/OFF} = 0 V, I _o = 0 mA			10	μA

TYPICAL CHARACTERISTICS (Reference Values)

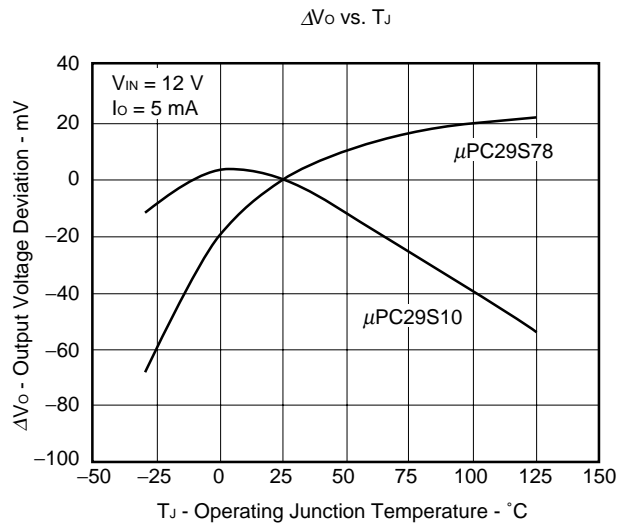
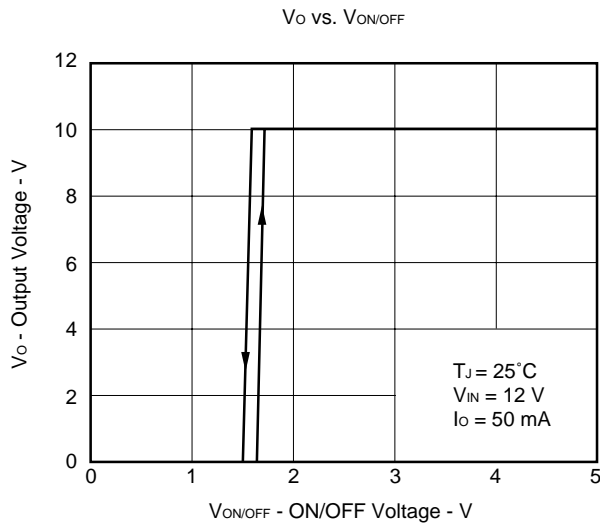
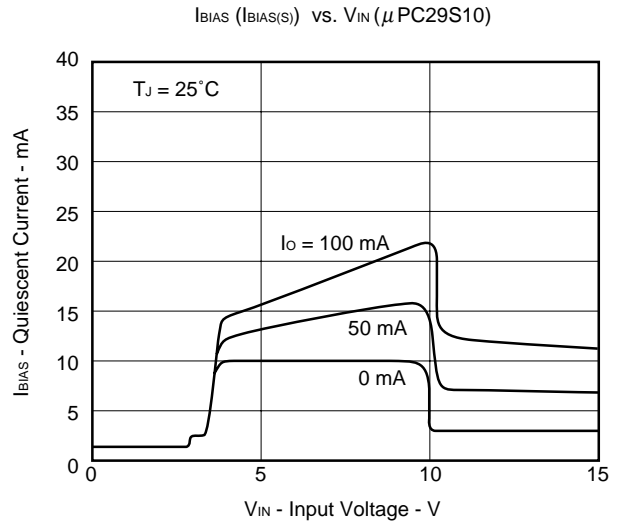
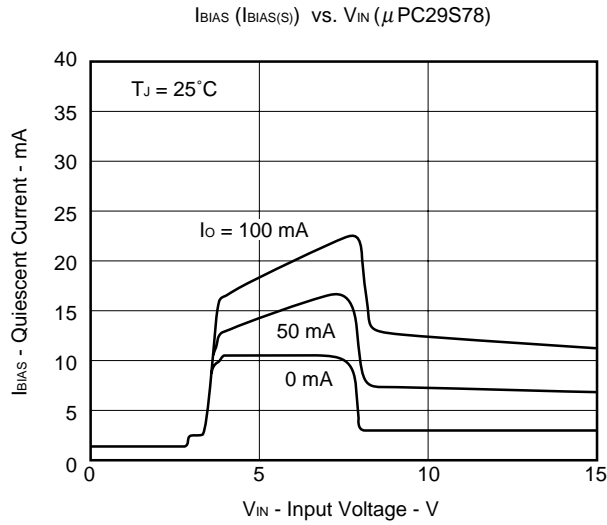
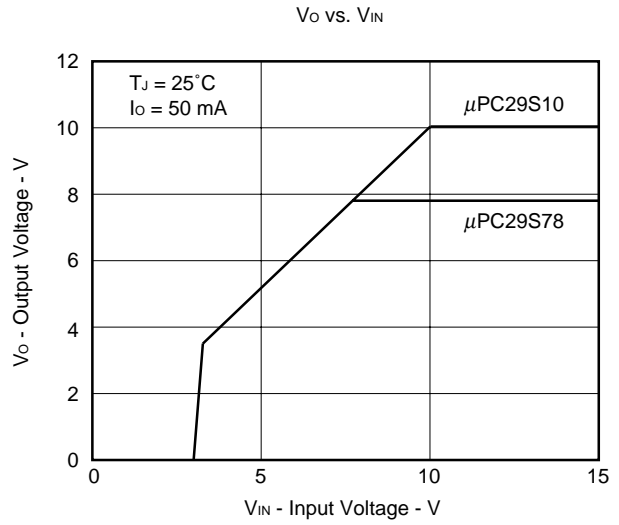
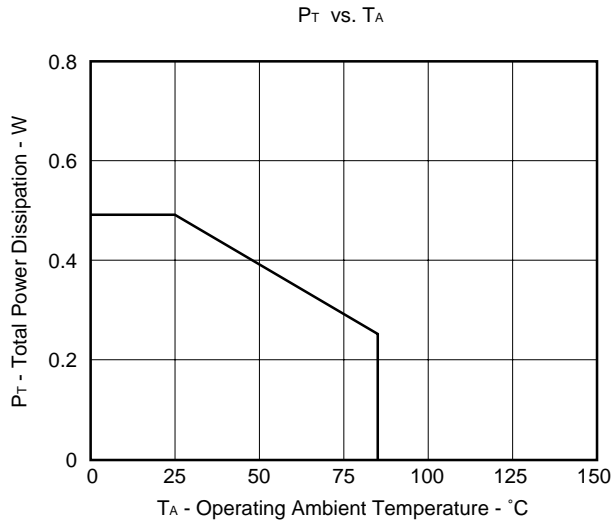

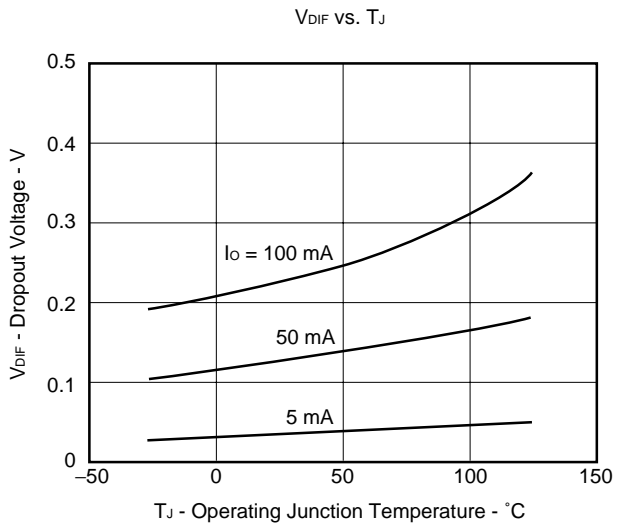
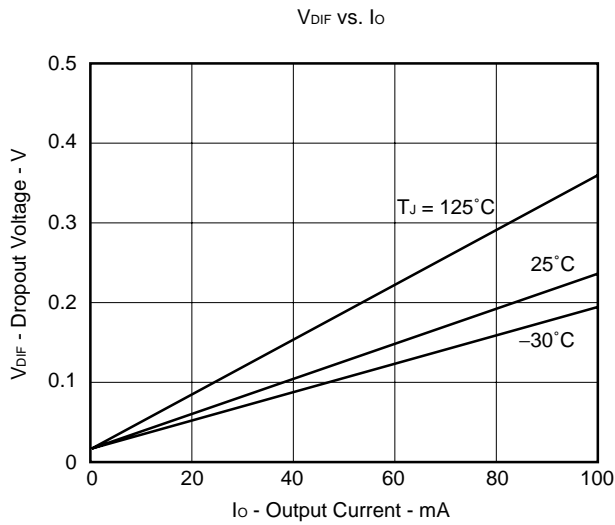
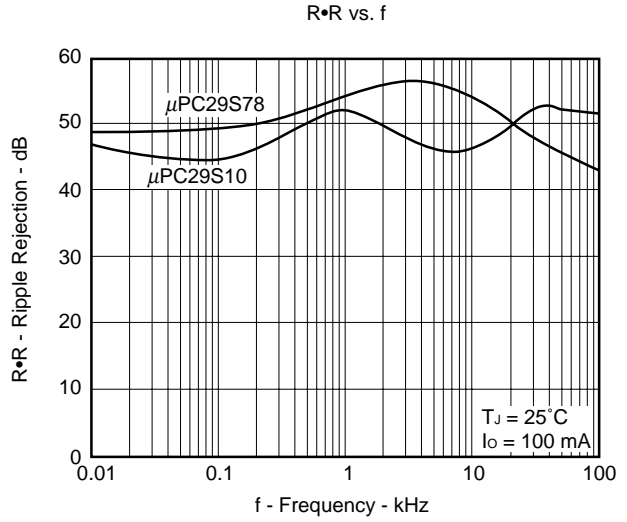
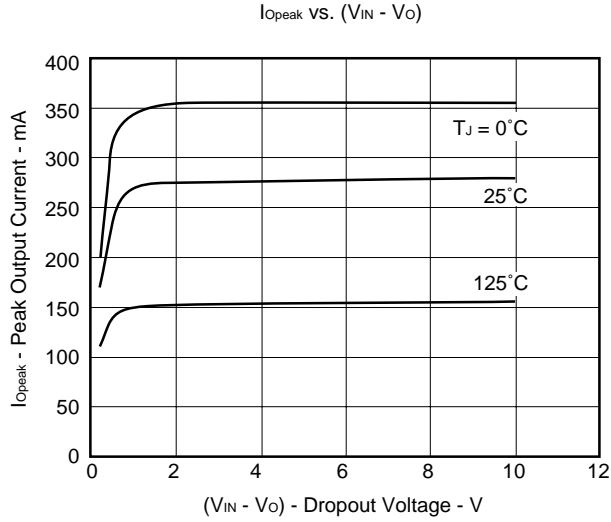

★ PACKAGE DRAWINGS (Unit: mm)

8-PIN PLASTIC SOP (5.72 mm (225))

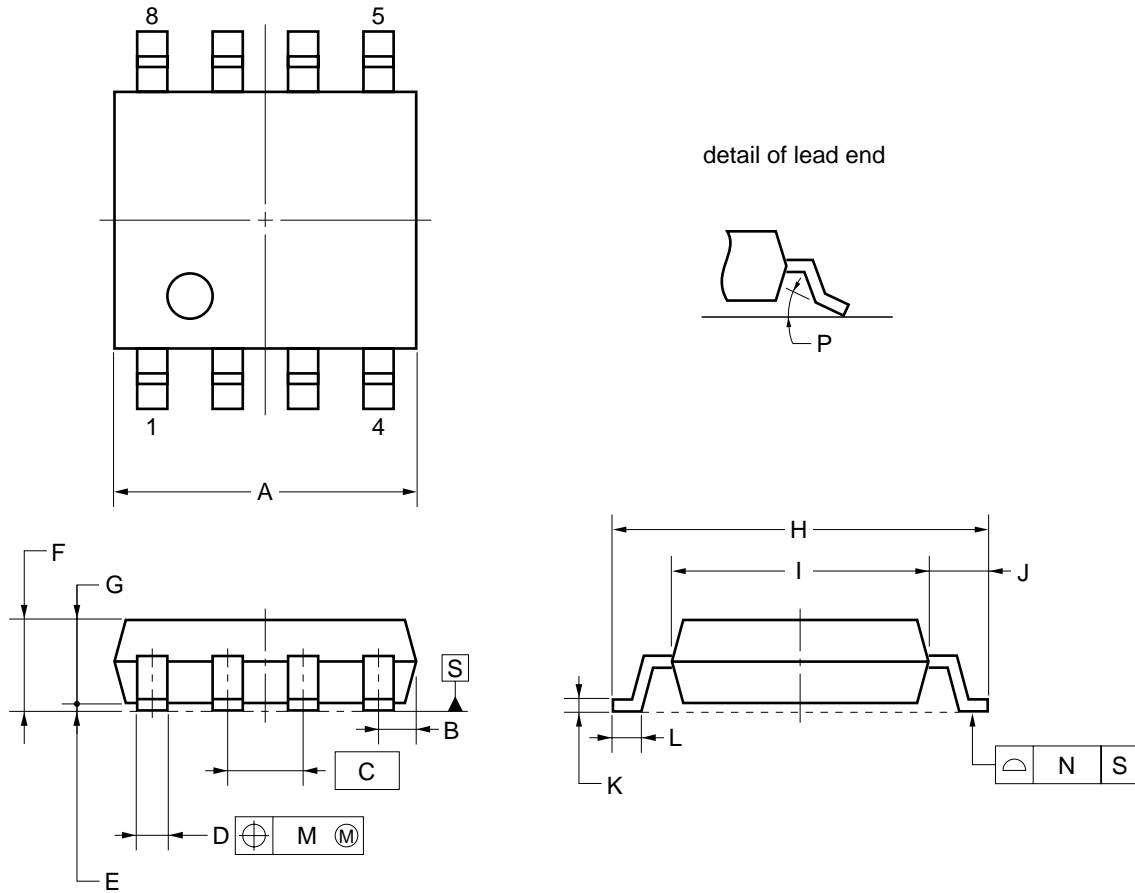

NOTE

Each lead centerline is located within 0.12 mm of its true position (T.P.) at maximum material condition.

ITEM	MILLIMETERS
A	5.2 ^{+0.17} / _{-0.20}
B	0.78 MAX.
C	1.27 (T.P.)
D	0.42 ^{+0.08} / _{-0.07}
E	0.1±0.1
F	1.59±0.21
G	1.49
H	6.5±0.3
I	4.4±0.15
J	1.1±0.2
K	0.17 ^{+0.08} / _{-0.07}
L	0.6±0.2
M	0.12
N	0.10
P	3° ^{+7°} / _{-3°}

S8GM-50-225B-6

RECOMMENDED SOLDERING CONDITIONS

When soldering this product, it is highly recommended to observe the conditions as shown below. If other soldering processes are used, or if the soldering is performed under different conditions, please make sure to consult with our sales offices.

For more details, refer to below our document.

"Semiconductor Device Mounting Technology Manual (C10535E)"

Type of Surface Mount Device

μPC29S78GR, μPC29S10GR: 8-PIN PLASTIC SOP (5.72 mm (225))

Process	Conditions	Symbol
Infrared Ray Reflow	Peak temperature: 235°C or below (Package surface temperature), Reflow time: 30 seconds or less (at 210°C or higher), Maximum number of reflow processes: 3 times.	IR35-00-3
Vapor Phase Soldering	Peak temperature: 215°C or below (Package surface temperature), Reflow time: 40 seconds or less (at 200°C or higher), Maximum number of reflow processes: 3 times.	VP15-00-3
Wave Soldering	Solder temperature: 260°C or below, Flow time: 10 seconds or less, Maximum number of flow processes: 1 time, Pre-heating temperature: 120°C or below (Package surface temperature).	WS60-00-1
Partial Heating Method	Pin temperature: 300°C or below, Heat time: 3 seconds or less (Per each side of the device).	—

Caution Apply only one kind of soldering condition to a device, except for "partial heating method", or the device will be damaged by heat stress.

CAUTION ON USE

When using the μ PC29S00 series at the input voltage which is lower than in the recommended operating condition the big quiescent current flows through device because the transistor of the output paragraph is saturated (Refer to the I_{BIAS} ($I_{BIAS(S)}$) vs. V_{IN} curves in TYPICAL CHARACTERISTICS). The specification of this characteristics is the start-up quiescent current, $I_{BIAS(S)}$. The μ PC29S00 series has saturation protection circuit, but they sometimes need about 50 mA current. Therefore, the power supply on the input needs the enough current capacity to pass this quiescent current when the device starts up.

★ REFERENCE DOCUMENTS

Usage of Three-Terminal Regulators (G12702E)

Quality Grades on NEC Semiconductor Devices (C11531E)

Semiconductor Device Mounting Technology Manual (C10535E)

Review of Quality and Reliability Handbook (C12769E)

Semiconductor Selection Guide -Products and Packages- (X13769X)

- The information in this document is current as of January, 2003. The information is subject to change without notice. For actual design-in, refer to the latest publications of NEC Electronics data sheets or data books, etc., for the most up-to-date specifications of NEC Electronics products. Not all products and/or types are available in every country. Please check with an NEC Electronics sales representative for availability and additional information.

- No part of this document may be copied or reproduced in any form or by any means without the prior written consent of NEC Electronics. NEC Electronics assumes no responsibility for any errors that may appear in this document.

- NEC Electronics does not assume any liability for infringement of patents, copyrights or other intellectual property rights of third parties by or arising from the use of NEC Electronics products listed in this document or any other liability arising from the use of such products. No license, express, implied or otherwise, is granted under any patents, copyrights or other intellectual property rights of NEC Electronics or others.

- Descriptions of circuits, software and other related information in this document are provided for illustrative purposes in semiconductor product operation and application examples. The incorporation of these circuits, software and information in the design of a customer's equipment shall be done under the full responsibility of the customer. NEC Electronics assumes no responsibility for any losses incurred by customers or third parties arising from the use of these circuits, software and information.

- While NEC Electronics endeavors to enhance the quality, reliability and safety of NEC Electronics products, customers agree and acknowledge that the possibility of defects thereof cannot be eliminated entirely. To minimize risks of damage to property or injury (including death) to persons arising from defects in NEC Electronics products, customers must incorporate sufficient safety measures in their design, such as redundancy, fire-containment and anti-failure features.

- NEC Electronics products are classified into the following three quality grades: "Standard", "Special" and "Specific".

The "Specific" quality grade applies only to NEC Electronics products developed based on a customer-designated "quality assurance program" for a specific application. The recommended applications of an NEC Electronics product depend on its quality grade, as indicated below. Customers must check the quality grade of each NEC Electronics product before using it in a particular application.

"Standard": Computers, office equipment, communications equipment, test and measurement equipment, audio and visual equipment, home electronic appliances, machine tools, personal electronic equipment and industrial robots.

"Special": Transportation equipment (automobiles, trains, ships, etc.), traffic control systems, anti-disaster systems, anti-crime systems, safety equipment and medical equipment (not specifically designed for life support).

"Specific": Aircraft, aerospace equipment, submersible repeaters, nuclear reactor control systems, life support systems and medical equipment for life support, etc.

The quality grade of NEC Electronics products is "Standard" unless otherwise expressly specified in NEC Electronics data sheets or data books, etc. If customers wish to use NEC Electronics products in applications not intended by NEC Electronics, they must contact an NEC Electronics sales representative in advance to determine NEC Electronics' willingness to support a given application.

(Note)

(1) "NEC Electronics" as used in this statement means NEC Electronics Corporation and also includes its majority-owned subsidiaries.

(2) "NEC Electronics products" means any product developed or manufactured by or for NEC Electronics (as defined above).