

FEATURES

- Low Noise Output LDO: 40 μ V_{RMS} Possible
- 1% Initial Accuracy
- Very Low Quiescent Current: 70 μ A
- Low Dropout Voltage (210mV at 150mA)
- Current and Thermal Limiting
- Reverse-Battery Protection
- Wide Range of Fix Output Voltages: 1.2V, 1.5V, 1.8V, 2.0V, 2.5V, 2.8V, 3.0V, 3.3V and 5.0V
- Zero Off-Mode Current
- Small 5-Pin SOT-23
- Pin Compatible to MIC5205/MAX8877 (fixed Options Only) and AS3815

Fixed Output Voltage

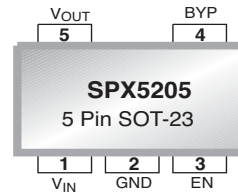

Adjustable Output Voltage

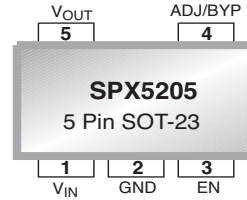

APPLICATIONS

- PDA
- Battery Powered Systems
- Cellular Phone
- Cordless Telephones
- Radio Control Systems
- Laptop, Palmtop, and Notebook Computers

Now Available in Lead Free Packaging

- Portable Consumer Equipment
- Portable Instrumentation
- Bar Code Scanners
- SMPS Post-Regulator

DESCRIPTION

The SPX5205 is a positive voltage regulator with very low dropout voltage, output noise and ground current (750 μ A at 100mA). V_{OUT} has a tolerance of less than 1% and is temperature compensated. Fixed output voltages 1.2V, 1.5V, 1.8V, 2.0V, 2.5V, 2.8V, 3.0V, 3.3V, and 5.0V and an adjustable version are available in a small 5-pin SOT-23 package. Other key features include zero off-mode current, reverse battery protection, thermal shutdown and current limit. The SPX5205 is an excellent choice for use in battery-powered applications, and where power conservation is desired such as: cellular/ cordless telephones, radio control systems, and portable computers.

TYPICAL APPLICATION CIRCUIT

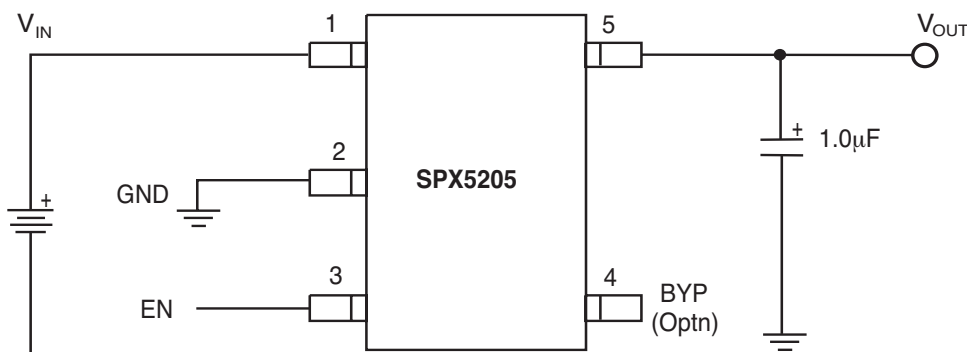

TOP View

ABSOLUTE MAXIMUM RATINGS

Thermal Shutdown	Internally Limited	Input Supply Voltage	-20V to +20V
Lead Temperature (Soldering, 5 seconds)	260°C	Enable Input Voltage	-20V to +20V
Operating Junction Temperature Range	-40°C to +125°C		

RECOMMENDED OPERATING CONDITIONS

Input voltage	+2.5V to 16V
Operating Junction Temperature Range	-40°C to +125°C
Enable Input Voltage	0V to V_{IN}
SOT-23-5 (θ_{JA})	See Note 1

ELECTRICAL CHARACTERISTICS

$T_J=25^\circ\text{C}$, $V_{IN} = V_{OUT} + 1\text{V}$, $I_L = 100\mu\text{A}$, $C_L = 1\mu\text{F}$, and $V_{ENABLE} \geq 2.4\text{V}$. The \blacklozenge denotes the specifications which apply over full temperature range -40°C to $+85^\circ\text{C}$, unless otherwise specified.

PARAMETER	MIN	TYP	MAX	UNITS	CONDITIONS
Output Voltage Tolerance (V_{OUT})	-1 -2		+1 +2	% V_{NOM}	\blacklozenge
Output Voltage Temperature Coefficient		57		ppm/ $^\circ\text{C}$	\blacklozenge
Line Regulation		0.03	0.1 0.2	%/V	\blacklozenge $V_{IN} = V_{OUT} + 1\text{V}$ to 16V
Load Regulation		0.1	0.2 0.5	%	\blacklozenge $I_L = 0.1\text{mA}$ to 150mA $V_{IN} = V_{OUT} + 1\text{V} \geq 2.5\text{V}$
Dropout Voltage (See Note 2) ($V_{IN} - V_O$)		30	50 70	mV	\blacklozenge $I_L = 100\mu\text{A}$
		140	190 230	mV	\blacklozenge $I_L = 50\text{mA}$
		180	250 300	mV	\blacklozenge $I_L = 100\text{mA}$
		210	275 350	mV	\blacklozenge $I_L = 150\text{mA}$
Quiescent Current (I_{GND})		0.05	1 5	μA	\blacklozenge $V_{ENABLE} \leq 0.4\text{V}$ $V_{ENABLE} \leq 0.25\text{V}$
Ground Pin Current (I_{GND})		70	125 150	μA	\blacklozenge $I_L = 100\mu\text{A}$
		350	600 800		\blacklozenge $I_L = 50\text{mA}$
		750	1000 1500		\blacklozenge $I_L = 100\text{mA}$
		1300	1900 2500		\blacklozenge $I_L = 150\text{mA}$
Ripple Rejection (PSRR)		70		dB	
Current Limit (I_{LIMIT})		360	500	mA	$V_{OUT} = 0\text{V}$
Output Noise (e_{NO})		300		μV_{RMS}	\blacklozenge $I_L = 10\text{mA}$, $C_L = 1\mu\text{F}$, $C_{IN} = 1\mu\text{F}$ (10Hz - 100kHz.)
		40		μV_{RMS}	\blacklozenge $I_L = 10\text{mA}$, $C_L = 10\mu\text{F}$, $C_{BYP} = 1\mu\text{F}$, $C_{IN} = 1\mu\text{F}$, (10Hz - 100kHz)
Input Voltage Level Logic Low (V_{IL})			0.4	V	OFF
Input Voltage Level Logic High (V_{IH})	2.0				ON
ENABLE Input Current		0.01 3	2 20	μA	\blacklozenge $V_{IL} \leq 0.4\text{V}$ $V_{IH} \geq 2.0\text{V}$

Note 1: The maximum allowable power dissipation is a function of maximum operating junction temperature, $T_{J(max)}$, the junction to ambient thermal resistance, and the ambient, θ_{JA} , and the ambient temperature T_A . The maximum allowable power dissipation at any ambient temperature is given: $P_{D(max)} = (T_{J(max)} - T_A)/\theta_{JA}$, exceeding the maximum allowable power limit will result in excessive die temperature; thus, the regulator will go into thermal shutdown. The θ_{JA} of the SPX5205 is 220°C/W mounted on a PC board.

Note 2: Not applicable to output voltages of less than 2V.

150mA, Low-Noise LDO Voltage Regulator

TYPICAL PERFORMANCE CHARACTERISTICS

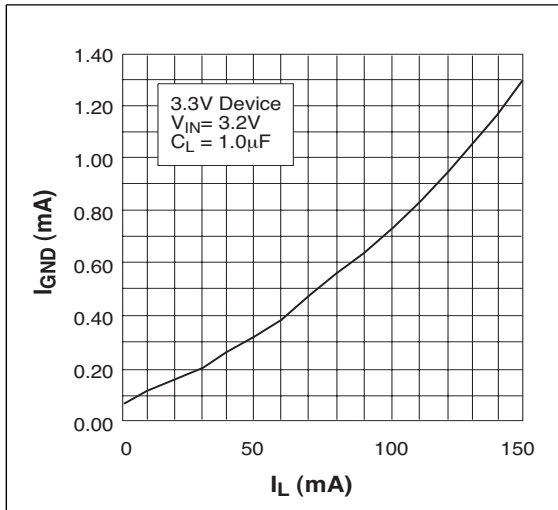

Ground Current vs Load Current

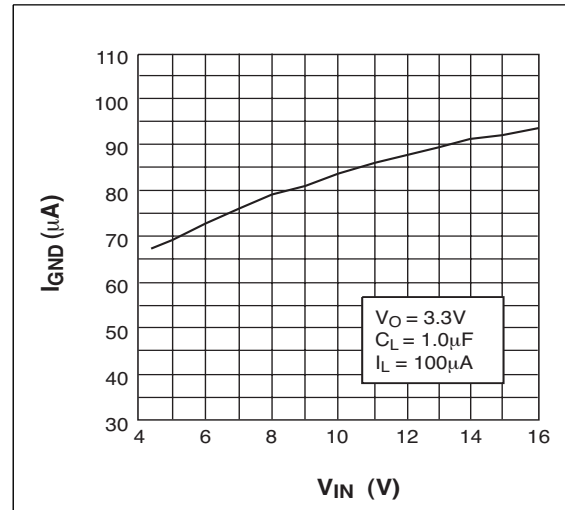

Ground Current vs Input Voltage

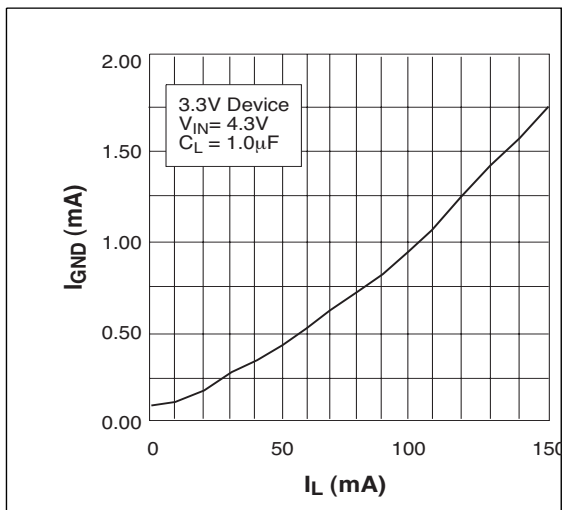

Ground Current vs Load Current in Dropout

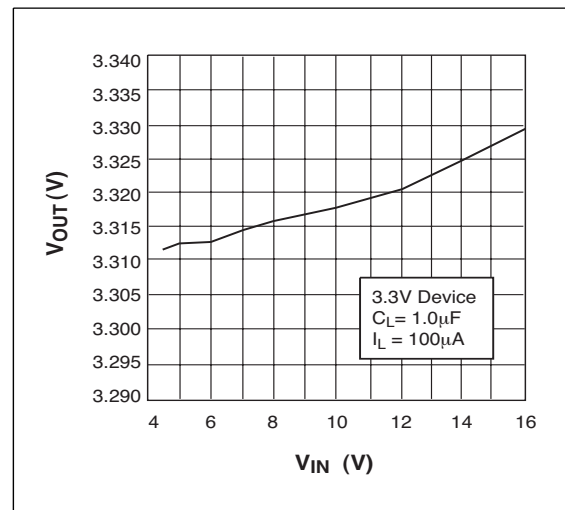

Output Voltage vs Input Voltage

TYPICAL PERFORMANCE CHARACTERISTICS

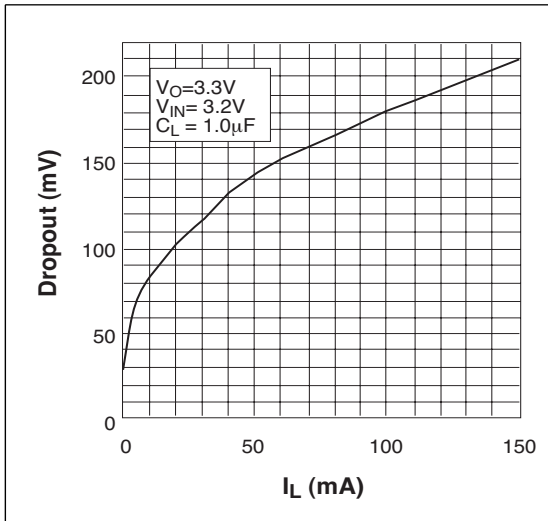

Dropout Voltage vs Load Current

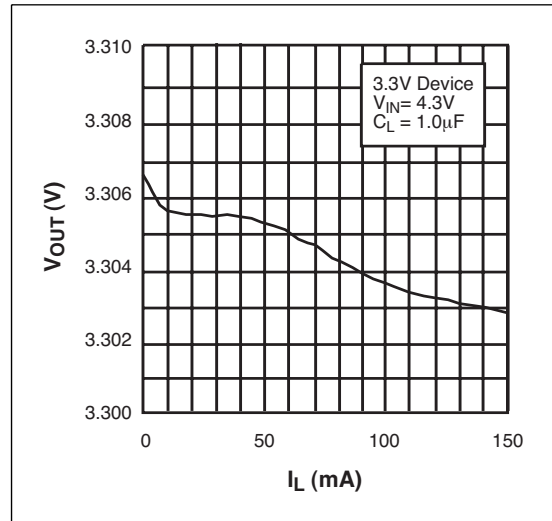

Output Voltage vs Load Current

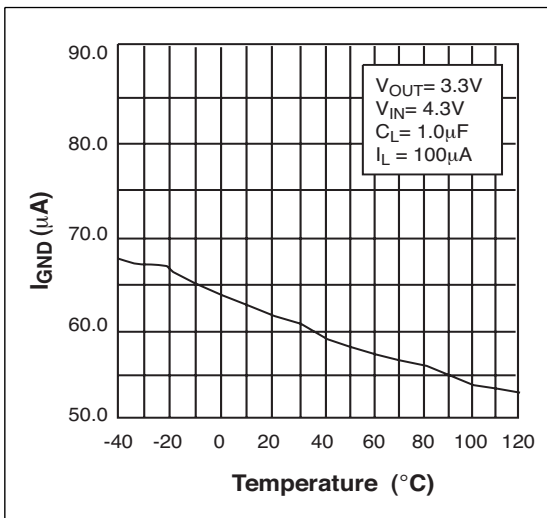

Ground Current vs Temperature at $I_{LOAD}=100\mu A$

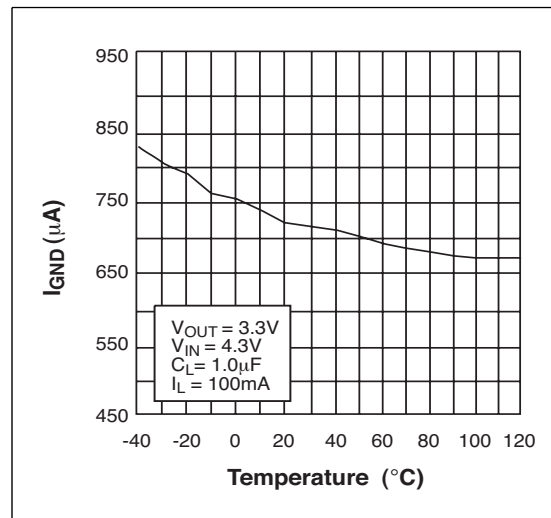

Ground Current vs Temperature at $I_{LOAD}=100mA$

150mA, Low-Noise LDO Voltage Regulator

TYPICAL PERFORMANCE CHARACTERISTICS

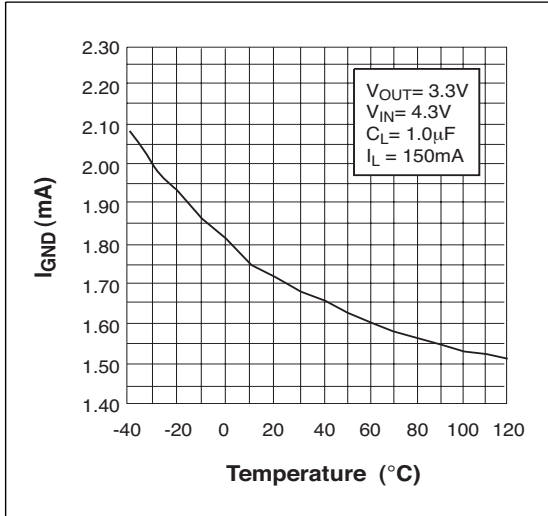

Ground Current in Dropout vs Temperature

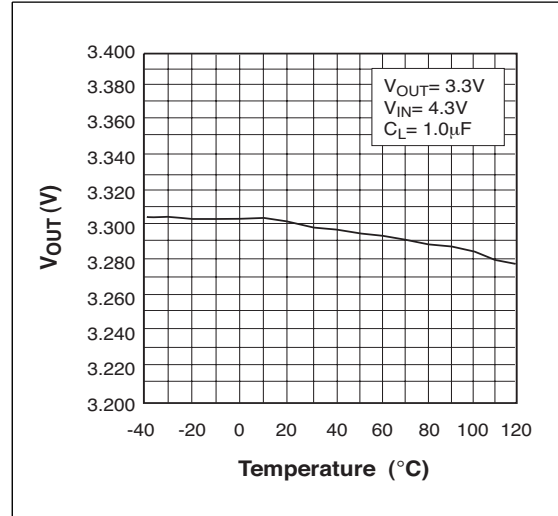

Output Voltage vs Temperature

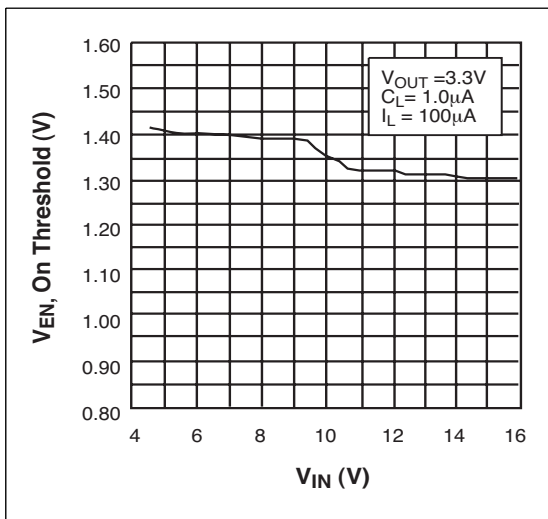

ENABLE Voltage, ON threshold vs Input Voltage

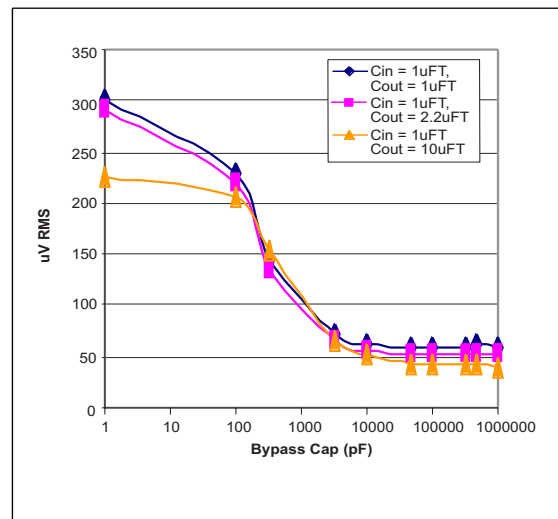

Output Noise vs. Bypass Capacitor Value

APPLICATION INFORMATION

The SPX5205 requires an output capacitor for device stability. Its value depends upon the application circuit. In general, linear regulator stability decreases with higher output currents. In applications where the SPX5205 is putting out less current, a lower output capacitance may be sufficient. For example, a regulator sourcing only 10mA, requires approximately half the capacitance as the same regulator sourcing 150mA.

Bench testing is the best method for determining the proper type and value of the capacitor since the high frequency characteristics of electrolytic capacitors vary widely, depending on type and manufacturer. A high quality 2.2µF aluminum electrolytic capacitor works in most application circuits, but the same stability often can be obtained with a 1µF tantalum electrolytic.

With the SPX5205 adjustable version, the minimum value of output capacitance is a function of the output voltage. The value decreases with higher output voltages, since closed loop gain is increased.

Typical Applications Circuits

A 10nF capacitor on BYP pin will significantly reduce output noise but it may be left unconnected if the output noise is not a major concern. The SPX5205 start-up speed is inversely pro-

portional to the size of the BYP capacitor. Applications requiring a slow ramp-up of the output voltage should use a larger C_{BYP}. However, if a rapid turn-on is necessary, the BYP capacitor can be omitted.

The SPX5205’s internal reference is available through the BYP pin.

The Typical Application Circuit shown on page 1 represents a SPX5205 standard application circuit. The EN (enable) pin is pulled high (>2.0V) to enable the regulator. To disable the regulator, EN < 0.4V.

The SPX5205 in Figure 1 illustrates a typical adjustable output voltage configuration. Two resistors (R1 and R2) set the output voltage. The output voltage is calculated using the formula:

$$V_{OUT} = 1.235V \times (1 + R1/R2)$$

R2 must be > 10 kΩ and for best results, R2 should be between 22 kΩ and 47kΩ. A capacitor placed between adjustable and ground will provide improved noise performance.

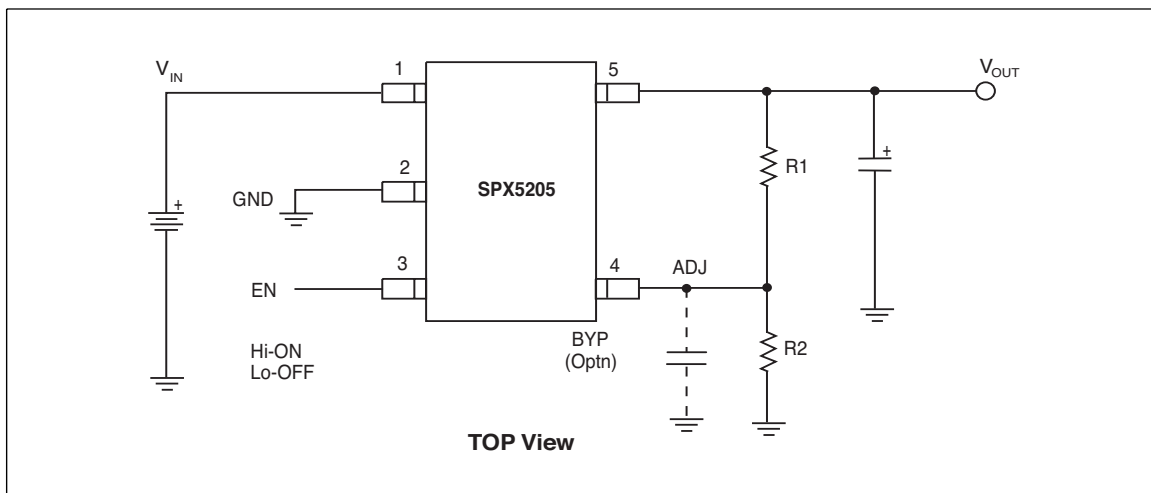
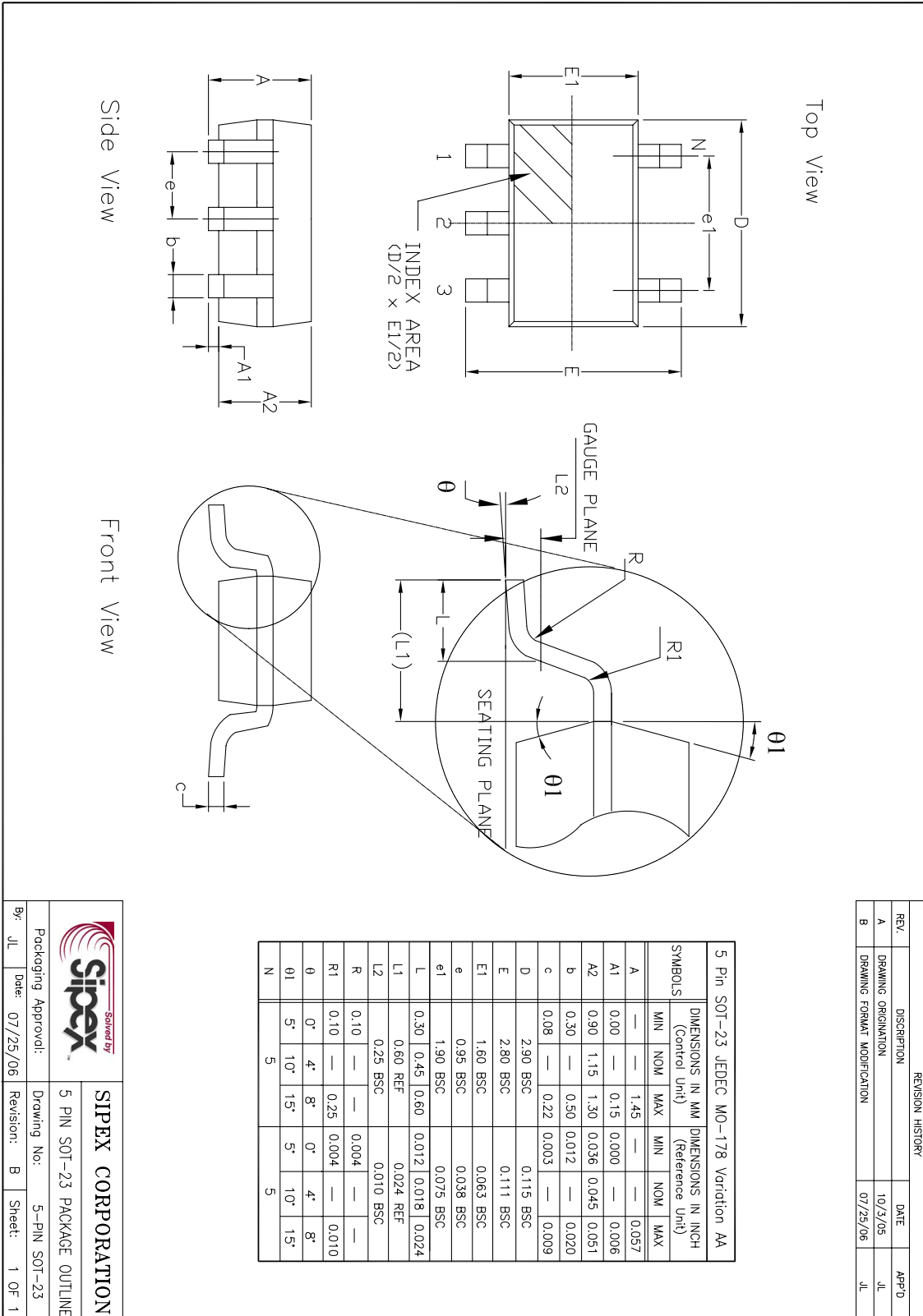

Figure 1. Typical Adjustable Output Voltage.

150mA, Low-Noise LDO Voltage Regulator



REVISION HISTORY			
REV.	DESCRIPTION	DATE	APP'D
A	DRAWING ORIGINATOR	10/23/05	JL
B	DRAWING FORMAT MODIFICATION	07/25/06	JL

SIPEX CORPORATION

5 PIN SOT-23 PACKAGE OUTLINE

By: JL Date: 07/25/06 Revision: B Sheet: 1 OF 1

ORDERING INFORMATION

PART NUMBER	TOP MARK	ACC.	OUTPUT VOLTAGE	PACKAGE
SPX5205M5	H1WW	1%	Adj	5 Pin SOT-23
SPX5205M5/TR	H1WW	1%	Adj	5 Pin SOT-23
SPX5205M5-1-2	R12	1%	1.2V	5 Pin SOT-23
SPX5205M5-1-2/TR	R12	1%	1.2V	5 Pin SOT-23
SPX5205M5-1-5	R15	1%	1.5V	5 Pin SOT-23
SPX5205M5-1-5/TR	R15	1%	1.5V	5 Pin SOT-23
SPX5205M5-1-8	R18	1%	1.8V	5 Pin SOT-23
SPX5205M5-1-8/TR	R18	1%	1.8V	5 Pin SOT-23
SPX5205M5-2-0	R20	1%	2.0V	5 Pin SOT-23
SPX5205M5-2-0/TR	R20	1%	2.0V	5 Pin SOT-23
SPX5205M5-2-5	R25	1%	2.5V	5 Pin SOT-23
SPX5205M5-2-5/TR	R25	1%	2.5V	5 Pin SOT-23
SPX5205M5-2-8	R28	1%	2.8V	5 Pin SOT-23
SPX5205M5-2-8/TR	R28	1%	2.8V	5 Pin SOT-23
SPX5205M5-3-0	R30	1%	3.0V	5 PIN SOT-23
SPX5205M5-3-0/TR	R30	1%	3.0V	5 PIN SOT-23
SPX5205M5-3-3	R33	1%	3.3V	5 Pin SOT-23
SPX5205M5-3-3/TR	R33	1%	3.3V	5 Pin SOT-23
SPX5205M5-5-0	R50	1%	5.0V	5 Pin SOT-23
SPX5205M5-5-0/TR	R50	1%	5.0V	5 Pin SOT-23

Available in lead free packaging. To order add “-L” suffix to part number.

Example: SPX5205M5-5-0/TR = standard; SPX5205M5-5-0-L/TR = lead free

Note that for top markings on small packages, when the bar is added to indicate lead-free parts, it can be mistaken as a “1” or an “l”.

/TR = Tape and Reel

Pack quantity is 2,500 for 5pin SOT-23

EXAR Corporation reserves the right to make changes to the products contained in this publication in order to improve design, performance or reliability. EXAR Corporation assumes no responsibility for the use of any circuits described herein, conveys no license under any patent or other right, and makes no representation that the circuits are free of patent infringement. Charts and schedules contained here in are only for illustration purposes and may vary depending upon a user’s specific application. While the information in this publication has been carefully checked; no responsibility, however, is assumed for inaccuracies.

EXAR Corporation does not recommend the use of any of its products in life support applications where the failure or malfunction of the product can reasonably be expected to cause failure of the life support system or to significantly affect its safety or effectiveness. Products are not authorized for use in such applications unless EXAR Corporation receives, in writing, assurances to its satisfaction that: (a) the risk of injury or damage has been minimized; (b) the user assumes all such risks; (c) potential liability of EXAR Corporation is adequately protected under the circumstances.

Copyright 2008 EXAR Corporation

Datasheet January 2008.