

为您的产品保驾护航

PRODUCT DATASHEET

Surface Mount PTC Devices

## ASMD0603 Series Surface Mount PTC Devices

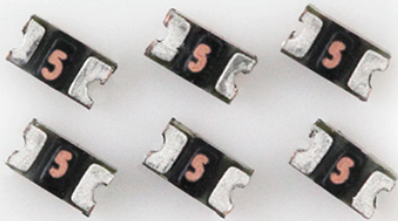

## Description



The ASMD0603 series provides miniature surface mount resettable overcurrent protection with holding current from 10mA to 1A.

This world's smallest PTC is suitable for ultra portable applications where space is at a premium and the device current is low.

## Features

- RoHS compliant and lead-free
- Low profile
- Halogen-free
- Fast response to fault current
- Compact design saves board space
- Compatible with high temperature solders

## Agency Approvals

Agency	File Number
	E472196
Regulation	Standard
	2002/95/EC
	EN14582

## Applications

- HDMI 1.4 Source protection
- PDAs / digital cameras
- Game console port protection
- PC motherboards-plug and play protection
- USB port protection - USB 2.0, 3.0&OTG

## Performance Specification

Model	V <sub>max</sub> (V dc)	I <sub>max</sub> (A)	I <sub>hold</sub> @25°C (A)	I <sub>trip</sub> @25°C (A)	P <sub>d</sub> Typ. (W)	Maximum Time To Trip		Resistance	
						Current (A)	Time (Sec)	R <sub>i min</sub> (Ω)	R <sub>1max</sub> (Ω)
ASMD0603-001	60	40	0.01	0.06	0.5	0.2	1.0	15.0	100
ASMD0603-002	60	40	0.02	0.08	0.5	0.2	1.0	12.0	70.0
ASMD0603-002-9V	9	40	0.02	0.08	0.5	0.2	1.0	12.0	70.0
ASMD0603-003	30	40	0.03	0.12	0.5	0.2	1.0	6.00	50.0
ASMD0603-003-9V	9	40	0.03	0.12	0.5	0.2	1.0	6.00	50.0
ASMD0603-003-60V	60	20	0.03	0.09	0.5	0.2	1.0	6.00	50.0
ASMD0603-004	15	20	0.04	0.12	0.5	0.2	1.0	4.00	40.0
ASMD0603-004-24V	24	20	0.04	0.12	0.5	0.2	1.0	4.00	40.0
ASMD0603-005	15	20	0.05	0.15	0.5	0.25	1.0	3.80	30.0
ASMD0603-005-9V	9	20	0.05	0.15	0.5	0.25	1.0	3.80	30.0
ASMD0603-005-24V	24	20	0.05	0.15	0.5	0.25	1.0	3.80	30.0
ASMD0603-005-30V	30	20	0.05	0.15	0.5	0.25	1.0	3.80	30.0
ASMD0603-010	15	40	0.10	0.30	0.5	0.5	1.0	0.90	6.00
ASMD0603-010-24V	24	40	0.10	0.30	0.5	0.5	1.0	0.90	6.00
ASMD0603-010-30V	30	40	0.10	0.30	0.5	0.5	1.0	0.90	6.00
ASMD0603-020	9	40	0.20	0.50	0.5	1.0	0.6	0.55	3.50
ASMD0603-020-16V	16	40	0.20	0.50	0.5	1.0	0.6	0.55	3.50
ASMD0603-025	9	40	0.25	0.50	0.5	1.0	0.6	0.50	3.00
ASMD0603-025-16V	16	40	0.25	0.50	0.5	1.0	0.6	0.50	3.00
ASMD0603-035	6	40	0.35	0.70	0.5	8.0	0.1	0.20	1.40
ASMD0603-035-16V	16	40	0.35	0.70	0.5	8.0	0.1	0.20	1.40
ASMD0603-040	6	40	0.40	0.80	0.5	8.0	0.1	0.15	0.90
ASMD0603-050	6	40	0.50	1.00	0.5	8.0	0.1	0.10	0.80
ASMD0603-050-12V	12	40	0.50	1.00	0.5	8.0	0.1	0.10	0.80
ASMD0603-075	6.0	40	0.75	1.50	0.5	8.0	0.1	0.06	0.45
ASMD0603-100	6.0	40	1.00	2.00	0.5	8.0	0.1	0.05	0.30

I<sub>hold</sub> = Hold Current. Maximum current device will not trip in 25°C still air.

I<sub>trip</sub> = Trip Current. Minimum current at which the device will always trip in 25°C still air.

V<sub>max</sub> = Maximum operating voltage device can withstand without damage at rated current (I<sub>max</sub>).

I<sub>max</sub> = Maximum fault current device can withstand without damage at rated voltage (V<sub>max</sub>).

P<sub>d</sub> = Power dissipation when device is in the tripped state in 25°C still air environment at rated voltage.

R<sub>i min/max</sub> = Minimum/Maximum device resistance prior to tripping at 25°C.

R<sub>1max</sub> = Maximum device resistance is measured one hour post reflow.

CAUTION : Operation beyond the specified ratings may result in damage and possible arcing and flame.

## Environmental Specifications

Test	Conditions	Resistance change
Passive aging	+85°C, 1000 hrs.	±5% typical
Humidity aging	+85°C, 85% R.H. , 168 hours	±5% typical
Thermal shock	+85°C to -40°C, 20 times	±33% typical
Resistance to solvent	MIL-STD-202,Method 215	No change
Vibration	MIL-STD-202,Method 201	No change

Ambient operating conditions : - 40 °C to +85 °C

Maximum surface temperature of the device in the tripped state is 125 °C

## Thermal Derating Curve

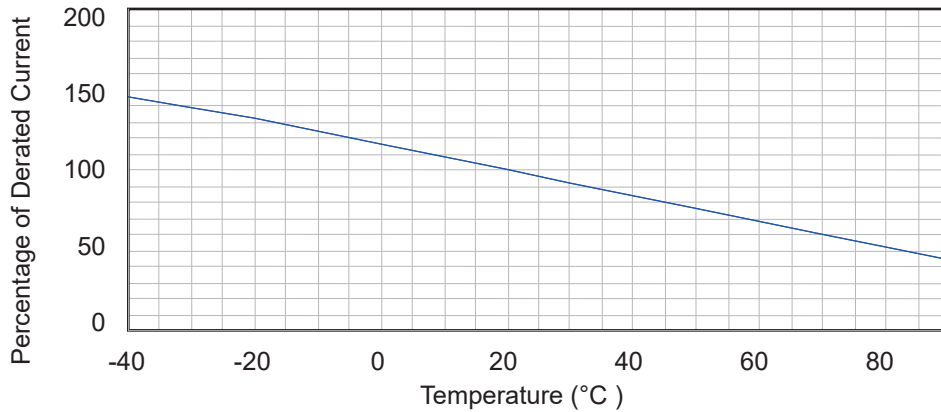

## Average Time-Current Curve

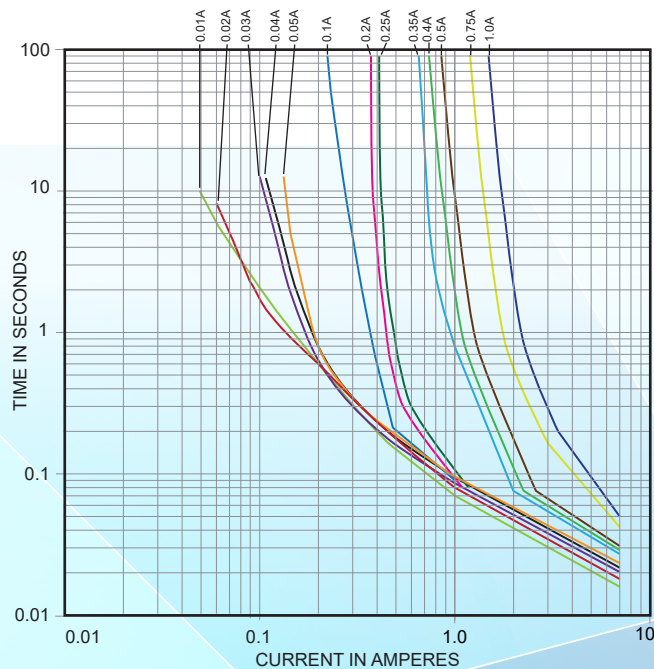

## Thermal Derating Chart

Model	Maximum ambient operating temperature ( $T_{mac}$ ) vs. hold current ( $I_{hold}$ )								
	- 40°C	- 20°C	0°C	25°C	40°C	50°C	60°C	70°C	85°C
ASMD0603-001	0.016	0.014	0.012	0.010	0.008	0.007	0.006	0.005	0.0035
ASMD0603-002	0.031	0.027	0.024	0.020	0.016	0.014	0.012	0.011	0.007
ASMD0603-003	0.047	0.041	0.036	0.030	0.024	0.021	0.018	0.016	0.0108
ASMD0603-004	0.052	0.048	0.044	0.040	0.032	0.028	0.024	0.020	0.012
ASMD0603-005	0.065	0.060	0.055	0.050	0.040	0.035	0.031	0.025	0.015
ASMD0603-010	0.13	0.12	0.11	0.10	0.08	0.07	0.06	0.05	0.03
ASMD0603-020	0.27	0.25	0.23	0.20	0.17	0.14	0.12	0.10	0.07
ASMD0603-025	0.32	0.29	0.27	0.25	0.21	0.18	0.16	0.14	0.10
ASMD0603-035	0.47	0.41	0.38	0.35	0.29	0.26	0.24	0.22	0.16
ASMD0603-040	0.54	0.47	0.43	0.40	0.33	0.30	0.27	0.23	0.16
ASMD0603-050	0.67	0.59	0.54	0.50	0.41	0.37	0.34	0.29	0.20
ASMD0603-075	0.98	0.85	0.81	0.75	0.60	0.54	0.44	0.40	0.31
ASMD0603-100	1.19	1.13	1.08	1.00	0.80	0.72	0.59	0.54	0.43

## Soldering Parameters

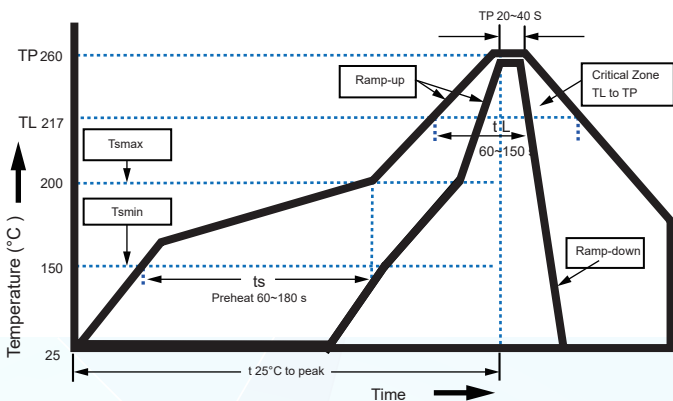

- Recommended reflow methods: IR, vapor phase oven, hot air oven, N2 environment for lead-free.
- Recommended maximum paste thickness is 0.25mm. Devices can be cleaned using standard industry methods and solvents.
- Note 1: All temperature refer to topside of the package, measured on the package body surface.
- Note 2: If reflow temperatures exceed the recommended profile, devices may not meet the performance requirements.

Profile Feature	Pb-Free Assembly
Average Ramp-Up Rate ( $T_s$ max to $T_p$ )	3°C/second max.
Preheat	
-Temperature Min( $T_s$ min)	150°C
-Temperature Max( $T_s$ max)	200°C
-Time( $T_s$ min to $T_s$ max)	60~180 seconds
Time maintained above:	
-Temperature(TL)	217°C
-Time(tL)	60~150 seconds
Peak Temperature( $T_p$ )	260°C
Ramp-Down Rate	6°C/second max.
Time 25°C to Peak Temperature	8 minutes max
Storage And Handling:	
Storage conditions	0°C~ 35°C, 30% ~60% R.H.
Devices may not meet specified performance if storage conditions are exceeded.	

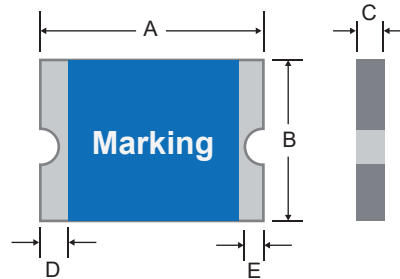
**Physical Dimensions(mm.)**

Model	A		B		C		D		E
	Min.	Max.	Min.	Max.	Min.	Max.	Min.	Max.	Min.
ASMD0603-001	1.45	1.85	0.65	1.05	0.40	0.80	0.15	0.50	0.05
ASMD0603-002	1.45	1.85	0.65	1.05	0.40	0.80	0.15	0.50	0.05
ASMD0603-002-9V	1.45	1.85	0.65	1.05	0.40	0.80	0.15	0.50	0.05
ASMD0603-003	1.45	1.85	0.65	1.05	0.40	0.80	0.15	0.50	0.05
ASMD0603-003-9V	1.45	1.85	0.65	1.05	0.40	0.80	0.15	0.50	0.05
ASMD0603-003-60V	1.45	1.85	0.65	1.05	0.40	1.00	0.15	0.50	0.10
ASMD0603-004	1.45	1.85	0.65	1.05	0.40	1.00	0.15	0.50	0.10
ASMD0603-004-24V	1.45	1.85	0.65	1.05	0.40	1.00	0.15	0.50	0.10
ASMD0603-005	1.45	1.85	0.65	1.05	0.40	1.00	0.15	0.50	0.10
ASMD0603-005-9V	1.45	1.85	0.65	1.05	0.40	1.00	0.15	0.50	0.10
ASMD0603-010	1.45	1.85	0.65	1.05	0.40	0.80	0.15	0.50	0.05
ASMD0603-010-30V	1.45	1.85	0.65	1.05	0.40	0.80	0.15	0.50	0.05
ASMD0603-020	1.45	1.85	0.65	1.05	0.40	0.80	0.15	0.50	0.05
ASMD0603-020-16V	1.45	1.85	0.65	1.05	0.40	0.80	0.15	0.50	0.05
ASMD0603-025	1.45	1.85	0.65	1.05	0.40	0.80	0.15	0.50	0.05
ASMD0603-025-16V	1.45	1.85	0.65	1.05	0.40	0.80	0.15	0.50	0.05
ASMD0603-035	1.45	1.85	0.65	1.05	0.40	0.80	0.15	0.50	0.05
ASMD0603-035-16V	1.45	1.85	0.65	1.05	0.50	0.90	0.15	0.50	0.05
ASMD0603-040	1.45	1.85	0.65	1.05	0.50	0.90	0.15	0.50	0.05
ASMD0603-050	1.45	1.85	0.65	1.05	0.50	0.90	0.15	0.50	0.05
ASMD0603-050-12V	1.45	1.85	0.65	1.05	0.50	0.90	0.15	0.50	0.05
ASMD0603-075	1.45	1.85	0.65	1.05	0.50	0.90	0.15	0.50	0.05
ASMD0603-100	1.45	1.85	0.65	1.05	0.55	1.15	0.15	0.50	0.10

**Termination Pad Characteristics**

Terminal pad materials: Tin-plated Nickel-Copper

Terminal pad solder ability: Meets EIA specification RS186-9E and ANSI/J-STD-002 Category 3

## Recommended Pad Layout and Packaging Quantity

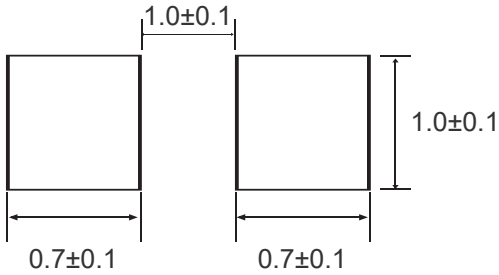

Part Number	Quantity
SMD0603 Series	4,000 pcs/reel
Tape & reel packaging per EIA481-1	

## Tape And Reel Specifications (mm)

Governing Specifications	EIA 481-1
W	8.00 ± 0.30
F	3.50 ± 0.10
E1	1.75 ± 0.10
D0	1.55 ± 0.05
D1	0.50 ± 0.10
P0	4.00 ± 0.10
P1	4.00 ± 0.10
P2	2.00 ± 0.05
A0	1.10 ± 0.10
B0	1.85 ± 0.10
T	0.20 ± 0.10
K0	0.72/0.85± 0.10
Leader	390 mm
Trailer	160 mm

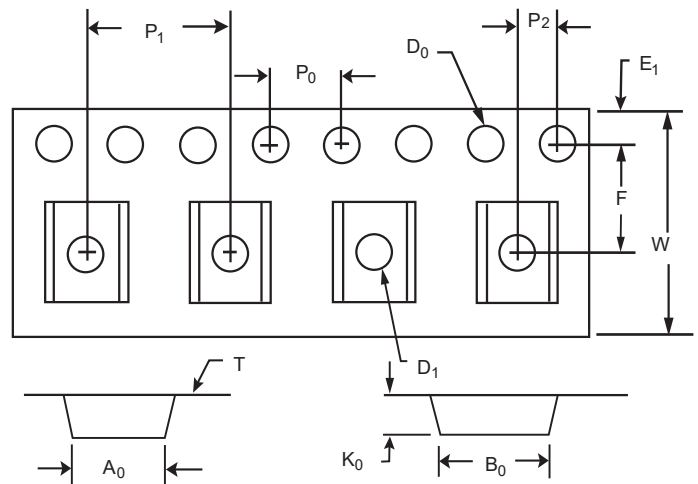

### REEL DIMENSIONS: EIA-481-1(mm)

C	φ 178 ± 1.0
D	φ 60.2 ± 0.5
W	9.0 ± 1.5
H	11.0 ± 0.5

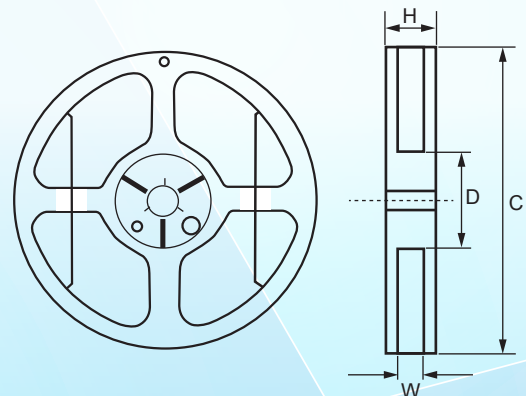

## Part Number System

**ASMD 0603 - □□□ - □□**

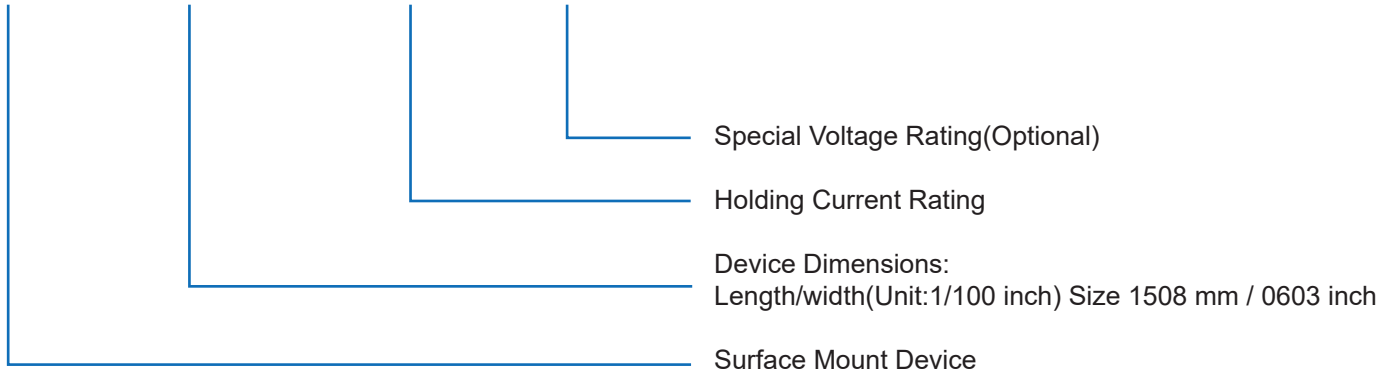

## Cross Reference

Model	Cross Reference		
	Tyco / PolySwitch®	Littelfuse / POLY-FUSE®	Polytronics / EVERFUSE®
ASMD0603-005	-	-	-
ASMD0603-010	-	0603L010	SMD0603P010TF
ASMD0603-020	-	0603L020	SMD0603P020TF
ASMD0603-025	-	0603L025	SMD0603P025TF
ASMD0603-035	-	0603L035	SMD0603P035TF
ASMD0603-050	-	0603L050	SMD0603P050TF

“PolySwitch” is a registered trademark of Tyco Electronics.

“POLY-FUSE” is a registered trademark of Littelfuse, Inc.

“EVERFUSE” is a registered trademark of Polytronics Technology Corp.



## Application Notice

1. Operation of these PPTC devices beyond the stated maximum ratings could result in damage to the devices and lead to electrical arcing and/or fire;

PPTC 器件在超过规定的最大值额定值运行可能会导致器件损坏以及导致电弧和/或火灾。

2. These PPTC devices are intended to protect against the effects of temporary over-current or over-temperature conditions and shall not be taken for use as switch.

PPTC 的作用是防止临时的过流或过温造成的不良影响，不能当作开关使用。

3. Exposure to lubricants, silicon-based oils, solvents, gels, electrolytes, acids, and other related or similar materials may adversely affect the performance of PPTC devices.

PPTC 接触润滑剂、硅基油、溶剂、凝胶、电解质、酸和其他相关或类似材料可能会对 PPTC 器件的性能有不利影响。

4. Circuits with inductance may generate a voltage above the rated voltage of the PPTC device and should be thoroughly evaluated within the user's application during the PPTC selection and qualification process.

带有电感的电路可能产生高于 PPTC 额定电压的电压，因此客户在选型和认定过程中应进行彻底的评估。

5. Please do not smash, clamp, pull, dent or twist by tool during assembling process, as they may result in the PPTC damage.

在装配过程中，避免有砸、挤、拉、扭等方式外力作用于 PPTC 本体上，因为它们可能导致 PPTC 损坏。

6. Hand-soldering of PPTC devices on boards is generally not recommended. Users shall define and verify this process if needed.

不推荐使用手工焊接的方式焊接 PPTC。如果需要，用户需要定义和验证此过程。

7. Recommended storage conditions should be followed at all times, The MSL classification of PPTC is grade 2a.

必须始终遵守推荐的保存条件要求，PPTC 的 MSL 等级为 2 a 级。