

R1171x SERIES

2.0A/1.5A LDO REGULATOR

NO. EA-125-220908

OUTLINE

The R1171x Series are CMOS-based positive voltage regulator ICs. The R1171x Series have features of low dropout voltage, high output voltage accuracy, low consumption current. Each of these ICs consists of a voltage reference unit, an error amplifier, resistor net for setting output voltage, a current limit circuit at short mode, a chip enable circuit, and thermal shutdown circuit. The output voltage of R1171 is fixed in the IC.

Low consumption current by the merit of CMOS process and built-in transistors with low ON-resistance make low dropout voltage and chip enable function prolongs the battery life. These regulators are remarkable improvement on the current regulators in terms of input transient response, and load transient response.

Thus, the R1171x Series are suitable for various power sources.

Since the packages for these ICs are high wattage HSOP-6J package, TO-252-5-P1, high density mounting of the ICs on boards is possible.

FEATURES

- Supply Current Typ. 130 μ A
- Standby Current Typ. 0.1 μ A
- Output Current Min. 1.5A ($V_{IN}=V_{OUT}+1.0V$, R1171Sxx1A/B)
Min. 2.0A ($V_{IN}=V_{OUT}+1.0V$, R1171Jxx1C/D)
- Input Voltage 2.1V to 6.0V
- Output Voltage 1.5V to 5.0V (0.1V steps) (R1171Sxx1A/B)
1.8V to 5.0V (0.1V steps) (R1171Jxx1C/D)
(For other voltages, please refer to MARK INFORMATIONS.)
- Output Voltage Accuracy $\pm 2.0\%$
- Dropout Voltage Typ. 0.09V ($V_{OUT}=3.0V$, $I_{OUT}=300mA$)
- Temperature-drift Coefficient of Output Voltage Typ. $\pm 100ppm/^{\circ}C$
- Line Regulation Typ. 0.05%/V
- Packages HSOP-6J, TO-252-5-P1
- Built-in Current Limit Circuit
- Built-in Thermal Shutdown Circuit
- Ceramic capacitor for phase compensation $C_{IN}=C_{OUT}=\text{Ceramic } 10\mu F$ ($V_{OUT}<1.8V$)
 $C_{IN}=C_{OUT}=\text{Ceramic } 4.7\mu F$ ($V_{OUT} \geq 1.8V$)

APPLICATIONS

- Local Power source for Notebook PC.
- Local Power source for portable appliances, cameras, and videos.
- Local Power source for equipment of battery-use.
- Local Power source for home appliances.

BLOCK DIAGRAMS

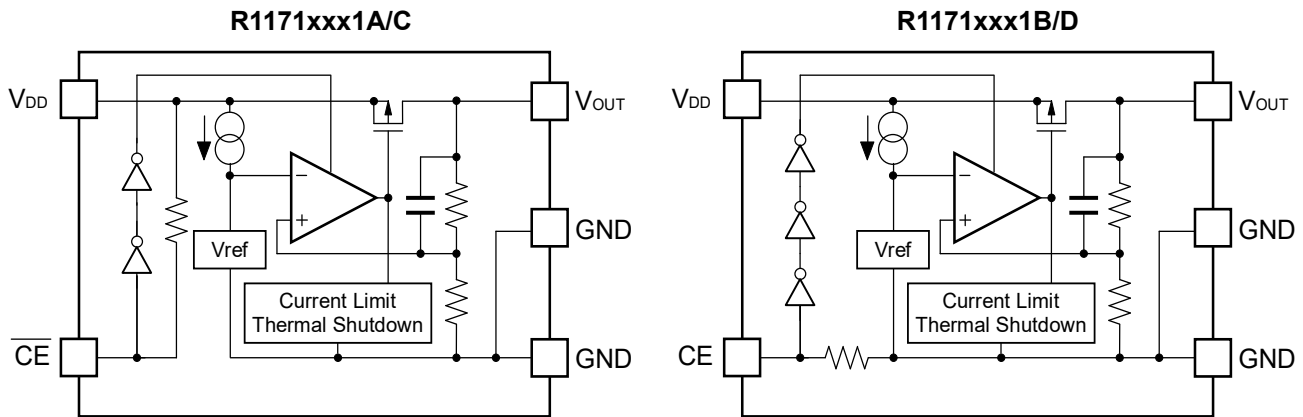

SELECTION GUIDE

The output voltage, chip enable polarity, package for the ICs can be selected at the user's request.

Product Name	Package	Quantity per Reel	Pb Free	Halogen Free
R1171Sxx1*-E2-FE	HSOP-6J	1,000 pcs	Yes	Yes
R1171Jyy1\$-T1-F	TO-252-5-P1	3,000 pcs	Yes	No

xx: The output voltage can be designated in the range from 1.5V(15) to 5.0V(50) in 0.1V steps.
(For other voltages, please refer to MARK INFORMATIONS.)

yy: The output voltage can be designated in the range from 1.8V(18) to 5.0V(50) in 0.1V steps.
(For other voltages, please refer to MARK INFORMATIONS.)

* : CE pin polarity are options as follows.

- (A) "L" active
- (B) "H" active

\$: CE pin polarity are options as follows.

- (C) "L" active
- (D) "H" active

PIN CONFIGURATIONS

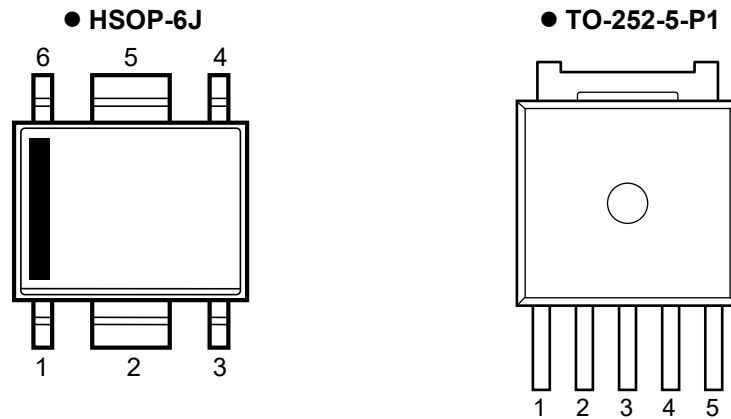

PIN DESCRIPTIONS

• HSOP-6J

Pin No	Symbol	Pin Description
1	V_{OUT}	Output Pin
2	GND	Ground Pin
3	\overline{CE} or CE	Chip Enable Pin
4	NC	No Connection
5	GND	Ground Pin
6	V_{DD}	Input Pin

• TO-252-5-P1

Pin No	Symbol	Pin Description
1	V_{OUT}	Output Pin
2	\overline{CE} or CE	Chip Enable Pin
3	GND	Ground Pin
4	GND	Ground Pin
5	V_{DD}	Input Pin

*) No.3 and No.4 pins must be wired short each other and connected to the GND plane when it is mounted on board.

ABSOLUTE MAXIMUM RATINGS

Symbol	Item	Rating	Unit
V_{IN}	Input Voltage	7.0	V
V_{CE}	Input Voltage (\overline{CE} or CE Input Pin)	-0.3 to $V_{IN}+0.3$	V
V_{OUT}	Output Voltage	-0.3 to $V_{IN}+0.3$	V
P_D	Power Dissipation (HSOP-6J)* ¹	1700	mW
	Power Dissipation (TO-252-5-P1)* ¹	1900	
T_{opt}	Operating Temperature	-40 to 85	°C
T_{stg}	Storage Temperature	-55 to 125	°C

*) For Power Dissipation, please refer to PACKAGE INFORMATION.

ABSOLUTE MAXIMUM RATINGS

Electronic and mechanical stress momentarily exceeded absolute maximum ratings may cause the permanent damages and may degrade the life time and safety for both device and system using the device in the field.

The functional operation at or over these absolute maximum ratings is not assured.

RECOMMENDED OPERATING CONDITIONS (ELECTRICAL CHARACTERISTICS)

All of electronic equipment should be designed that the mounted semiconductor devices operate within the recommended operating conditions. The semiconductor devices cannot operate normally over the recommended operating conditions, even if when they are used over such conditions by momentary electronic noise or surge. And the semiconductor devices may receive serious damage when they continue to operate over the recommended operating conditions.

ELECTRICAL CHARACTERISTICS

• R1171Sxx1A

T_{opt}=25°C

Symbol	Item	Conditions	Min.	Typ.	Max.	Unit	
V _{OUT}	Output Voltage	V _{IN} -V _{OUT} =1.0V, I _{OUT} =200mA	×0.98		×1.02	V	
$\frac{\Delta V_{OUT}}{\Delta I_{OUT}}$	Load Regulation	V _{IN} -V _{OUT} =1.0V 1mA ≤ I _{OUT} ≤ 300mA		10	60	mV	
V _{DIF}	Dropout Voltage	I _{OUT} =300mA	1.5 ≤ V _{OUT} <1.6		0.16	0.35	V
			1.6 ≤ V _{OUT} <1.7		0.14	0.32	
			1.7 ≤ V _{OUT} <1.8		0.13	0.28	
			1.8 ≤ V _{OUT} <2.0		0.12	0.24	
			2.0 ≤ V _{OUT} <2.5		0.10	0.21	
			2.5 ≤ V _{OUT} ≤ 5.0		0.09	0.18	
I _{SS}	Supply Current	V _{IN} -V _{OUT} =1.0V, V _{CE} =0V		130	320	μA	
I _{standby}	Standby Current	V _{IN} -V _{OUT} =1.0V, V _{IN} =V _{CE}		0.1	2.0	μA	
$\frac{\Delta V_{OUT}}{\Delta V_{IN}}$	Line Regulation	I _{OUT} =200mA	Refer to the following table				
RR	Ripple Rejection	f=1kHz, Ripple 0.5Vp-p					
V _{IN}	Input Voltage		2.1		6.0	V	
$\frac{\Delta V_{OUT}}{\Delta T_{opt}}$	Output Voltage Temperature Coefficient	I _{OUT} =10mA -40°C ≤ T _{opt} ≤ 85°C		±100		ppm/°C	
I _{LIM}	Output Current	V _{IN} -V _{OUT} =1.0V	1.5			A	
I _{SC}	Short Current Limit	V _{OUT} =0V		200		mA	
R _{PU}	Pull-up resistance for \overline{CE} pin		2.5	5.0	10.0	MΩ	
V _{CEH}	\overline{CE} Input Voltage "H"		1.2		V _{IN}	V	
V _{CEL}	\overline{CE} Input Voltage "L"		0		0.25	V	
T _{TSD}	Thermal Shutdown Detector Threshold Temperature	Junction Temperature		150		°C	
T _{TSR}	Thermal Shutdown Released Temperature	Junction Temperature		120		°C	

• Line Regulation by Output Voltage

T_{opt}=25°C

Output Voltage V _{OUT} (V)	Line Regulation $\Delta V_{OUT}/\Delta V_{IN}$ (%/V)		
	Condition	Typ.	Max.
1.5 ≤ V _{OUT} < 1.6	I _{OUT} =200mA, 2.1V ≤ V _{IN} ≤ 6.0V	0.05	0.30
1.6 ≤ V _{OUT} ≤ 5.0			

• Ripple Rejection by Output Voltage

T_{opt}=25°C

Output Voltage V _{OUT} (V)	Ripple Rejection RR (dB)	
	Condition	Typ.
1.5 ≤ V _{OUT} < 4.7	f=1kHz, Ripple 0.5Vp-p, V _{IN} -V _{OUT} =1.0V	50
4.7 ≤ V _{OUT} ≤ 5.0		

● **R1171Sxx1B**

T_{opt}=25°C

Symbol	Item	Conditions	Min.	Typ.	Max.	Unit	
V _{OUT}	Reference Voltage for Adjustable Voltage Regulator	V _{IN} -V _{OUT} =1.0V I _{OUT} =200mA	×0.98		×1.02	V	
ΔV _{OUT} /ΔI _{OUT}	Load Regulation	V _{IN} -V _{OUT} =1.0V 1mA ≤ I _{OUT} ≤ 300mA		10	60	mV	
V _{DIF}	Dropout Voltage	I _{OUT} =300mA		1.5 ≤ V _{OUT} <1.6	0.16	0.35	V
				1.6 ≤ V _{OUT} <1.7	0.14	0.32	
				1.7 ≤ V _{OUT} <1.8	0.13	0.28	
				1.8 ≤ V _{OUT} <2.0	0.12	0.24	
				2.0 ≤ V _{OUT} <2.5	0.10	0.21	
				2.5 ≤ V _{OUT} ≤ 5.0	0.09	0.18	
I _{SS}	Supply Current	V _{IN} -V _{OUT} =1.0V, V _{CE} =V _{IN}		130	320	μA	
I _{standby}	Standby Current	V _{IN} -V _{OUT} =1.0V, V _{CE} =0V		0.1	2.0	μA	
ΔV _{OUT} /ΔV _{IN}	Line Regulation	I _{OUT} =200mA	Refer to the following table				
RR	Ripple Rejection	f=1kHz, Ripple 0.5Vp-p					
V _{IN}	Input Voltage		2.1		6.0	V	
ΔV _{OUT} /ΔT _{opt}	Output Voltage Temperature Coefficient	I _{OUT} =10mA -40°C ≤ T _{opt} ≤ 85°C		±100		ppm/°C	
I _{LIM}	Output Current	V _{IN} -V _{OUT} =1.0V	1.5			A	
I _{SC}	Short Current Limit	V _{OUT} =0V		200		mA	
R _{PD}	Pull-down resistance for CE pin		2.5	5.0	10.0	MΩ	
V _{CEH}	CE Input Voltage "H"		1.2		V _{IN}	V	
V _{CEL}	CE Input Voltage "L"		0		0.25	V	
T _{TSD}	Thermal Shutdown Detector Threshold Temperature	Junction Temperature		150		°C	
T _{TSR}	Thermal Shutdown Released Temperature	Junction Temperature		120		°C	

● **Line Regulation by Output Voltage**

T_{opt}=25°C

Output Voltage V _{OUT} (V)	Line Regulation ΔV _{OUT} /ΔV _{IN} (%/V)		
	Condition	Typ.	Max.
1.5 ≤ V _{OUT} < 1.6	I _{OUT} =200mA, 2.1V ≤ V _{IN} ≤ 6.0V	0.05	0.30
1.6 ≤ V _{OUT} ≤ 5.0			

● **Ripple Rejection by Output Voltage**

T_{opt}=25°C

Output Voltage V _{OUT} (V)	Ripple Rejection RR (dB)	
	Condition	Typ.
1.5 ≤ V _{OUT} < 4.7	f=1kHz, Ripple 0.5Vp-p, V _{IN} -V _{OUT} =1.0V	50
4.7 ≤ V _{OUT} ≤ 5.0		

● R1171Jxx1C

T_{opt}=25°C

Symbol	Item	Conditions	Min.	Typ.	Max.	Unit
V _{OUT}	Output Voltage	V _{IN} -V _{OUT} =1.0V I _{OUT} =200mA	×0.98		×1.02	V
ΔV _{OUT} / ΔI _{OUT}	Load Regulation	V _{IN} -V _{OUT} =1.0V 1mA ≤ I _{OUT} ≤ 300mA		10	60	mV
V _{DIF}	Dropout Voltage	I _{OUT} =300mA	1.8 ≤ V _{OUT} <2.0	0.12	0.24	V
			2.0 ≤ V _{OUT} <2.5	0.10	0.21	
			2.5 ≤ V _{OUT} ≤ 5.0	0.09	0.18	
I _{SS}	Supply Current	V _{IN} -V _{OUT} =1.0V, V _{CE} =0V		130	320	μA
I _{standby}	Standby Current	V _{IN} -V _{OUT} =1.0V, V _{IN} =V _{CE}		0.1	2.0	μA
ΔV _{OUT} / ΔV _{IN}	Line Regulation	I _{OUT} =200mA V _{OUT} +0.5V ≤ V _{IN} ≤ 6V		0.05	0.30	%/V
RR	Ripple Rejection	f=1kHz, Ripple 0.5Vp-p	Refer to the following table			
V _{IN}	Input Voltage		2.1		6.0	V
ΔV _{OUT} / ΔT _{opt}	Output Voltage Temperature Coefficient	I _{OUT} =10mA -40°C ≤ T _{opt} ≤ 85°C		±100		ppm/°C
I _{LIM}	Output Current	V _{IN} -V _{OUT} =1.0V	2.0			A
I _{SC}	Short Current Limit	V _{OUT} =0V		200		mA
R _{PU}	Pull-up resistance for \overline{CE} pin		2.5	5.0	10.0	MΩ
V _{CEH}	\overline{CE} Input Voltage "H"		1.2		V _{IN}	V
V _{CEL}	\overline{CE} Input Voltage "L"		0		0.25	V
T _{TSD}	Thermal Shutdown Detector Threshold Temperature	Junction Temperature		150		°C
T _{TSR}	Thermal Shutdown Released Temperature	Junction Temperature		120		°C

● Ripple Rejection by Output Voltage

T_{opt}=25°C

Output Voltage V _{OUT} (V)	Ripple Rejection RR (dB)	
	Condition	Typ.
1.8 ≤ V _{OUT} < 4.7	f=1kHz, Ripple 0.5Vp-p, V _{IN} -V _{OUT} =1.0V	50
4.7 ≤ V _{OUT} ≤ 5.0	f=1kHz, Ripple 0.5Vp-p, V _{IN} =5.75V	

*R1171J (TO-252-5) is the discontinued product as of September 2022.

R1171x

NO. EA-125-220908

● **R1171Jxx1D**

T_{opt}=25°C

Symbol	Item	Conditions	Min.	Typ.	Max.	Unit
V _{OUT}	Reference Voltage for Adjustable Voltage Regulator	V _{IN} -V _{OUT} =1.0V I _{OUT} =200mA	×0.98		×1.02	V
ΔV _{OUT} / ΔI _{OUT}	Load Regulation	V _{IN} -V _{OUT} =1.0V 1mA ≤ I _{OUT} ≤ 300mA		10	60	mV
V _{DIF}	Dropout Voltage	I _{OUT} =300mA	1.8 ≤ V _{OUT} <2.0	0.12	0.24	V
			2.0 ≤ V _{OUT} <2.5	0.10	0.21	
			2.5 ≤ V _{OUT} ≤ 5.0	0.09	0.18	
I _{SS}	Supply Current	V _{IN} -V _{OUT} =1.0V, V _{CE} =V _{IN}		130	320	μA
I _{standby}	Standby Current	V _{IN} -V _{OUT} =1.0V, V _{CE} =0V		0.1	2.0	μA
ΔV _{OUT} / ΔV _{IN}	Line Regulation	I _{OUT} =200mA V _{OUT} +0.5V ≤ V _{IN} ≤ 6V		0.05	0.30	%/V
RR	Ripple Rejection	f=1kHz, Ripple 0.5Vp-p	Refer to the following table			
V _{IN}	Input Voltage		2.1		6.0	V
ΔV _{OUT} / ΔT _{opt}	Output Voltage Temperature Coefficient	I _{OUT} =10mA -40°C ≤ T _{opt} ≤ 85°C		±100		ppm/°C
I _{LIM}	Output Current	V _{IN} -V _{OUT} =1.0V	2.0			A
I _{SC}	Short Current Limit	V _{OUT} =0V		200		mA
R _{PD}	Pull-down resistance for CE pin		2.5	5.0	10.0	MΩ
V _{CEH}	CE Input Voltage "H"		1.2		V _{IN}	V
V _{CEL}	CE Input Voltage "L"		0		0.25	V
T _{TSD}	Thermal Shutdown Detector Threshold Temperature	Junction Temperature		150		°C
T _{TSR}	Thermal Shutdown Released Temperature	Junction Temperature		120		°C

● **Ripple Rejection by Output Voltage**

T_{opt}=25°C

Output Voltage V _{OUT} (V)	Ripple Rejection RR (dB)	
	Condition	Typ.
1.8 ≤ V _{OUT} < 4.7	f=1kHz, Ripple 0.5Vp-p, V _{IN} -V _{OUT} =1.0V	50
4.7 ≤ V _{OUT} ≤ 5.0	f=1kHz, Ripple 0.5Vp-p, V _{IN} =5.75V	

TEST CIRCUITS

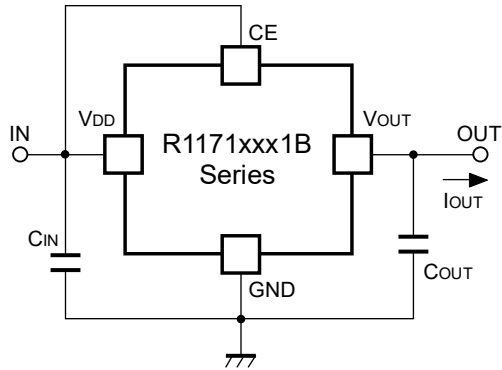

Standard Test Circuit

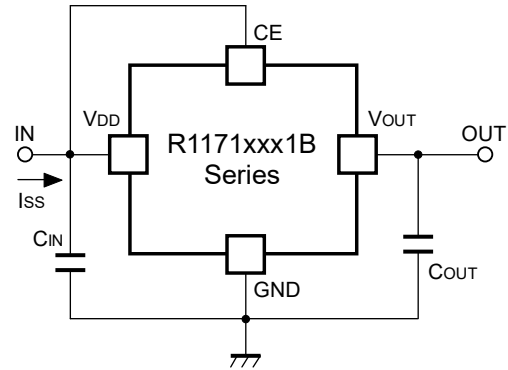

Supply Current Test Circuit

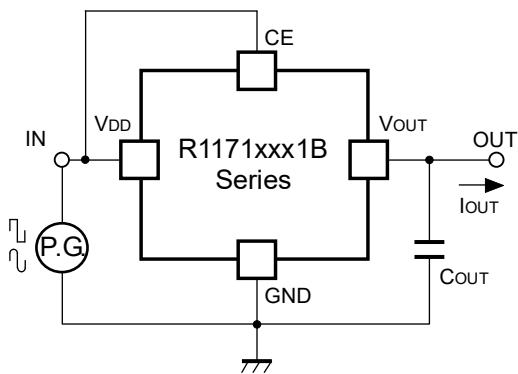

**Test Circuit for Ripple Rejection,
Input Transient Response**

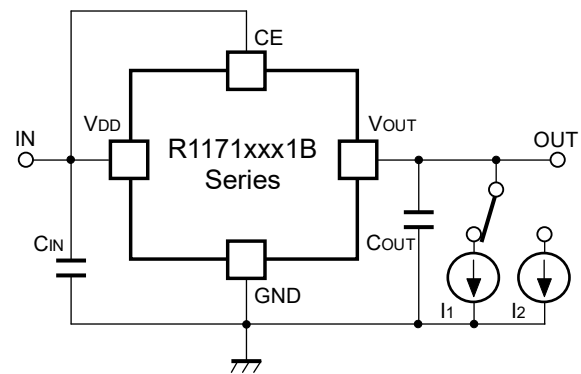

Test Circuit for Load Transient Response

TYPICAL CHARACTERISTICS

1) Output Voltage vs. Output Current (Topt=25°C)

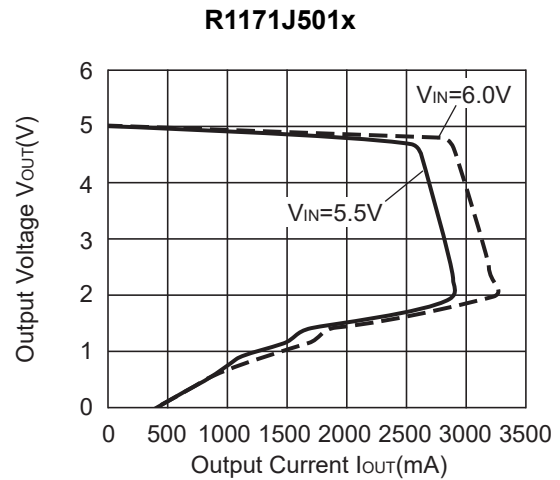
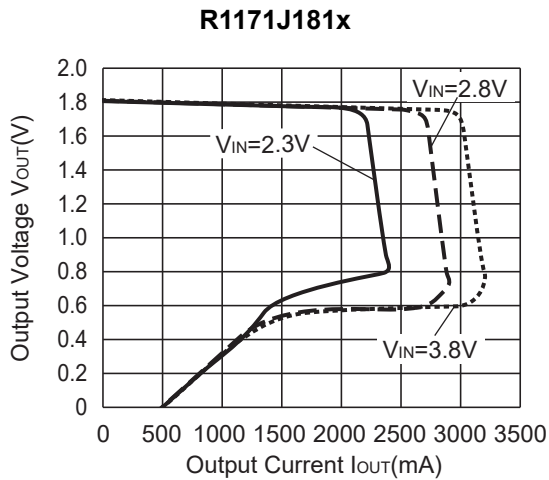
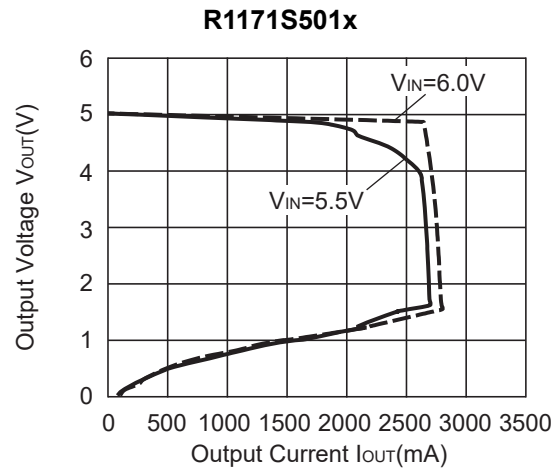
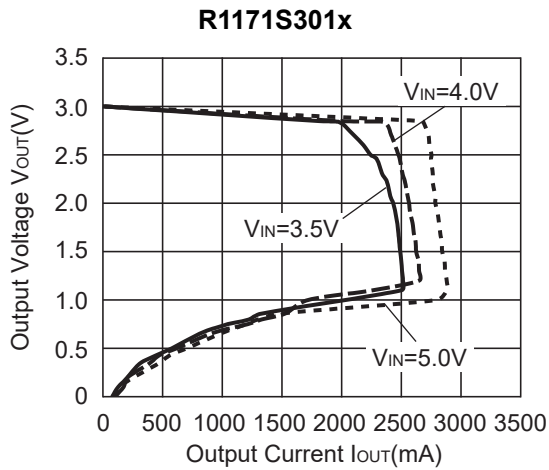
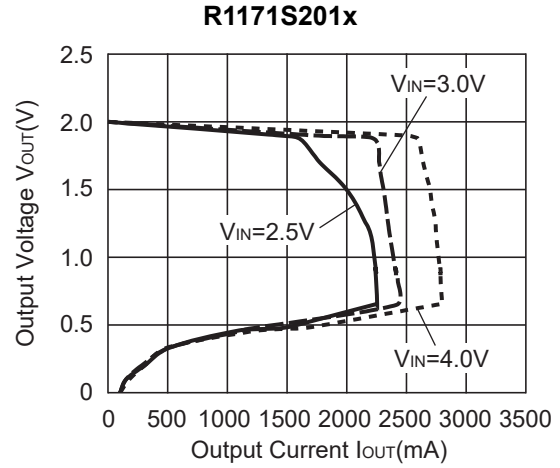
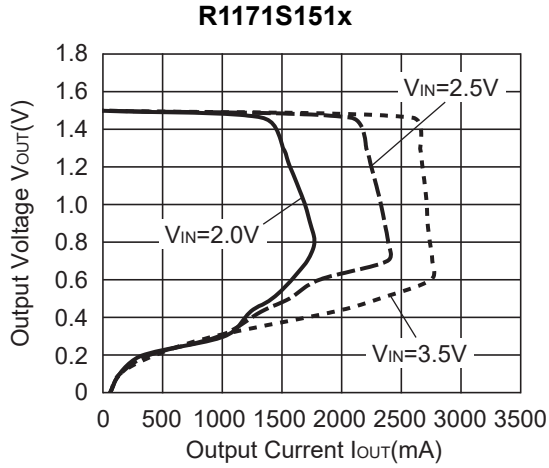

2) Output Voltage vs. Input Voltage (T_{opt}=25°C)

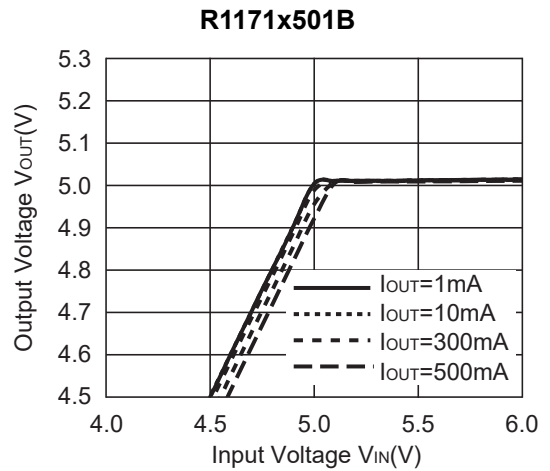
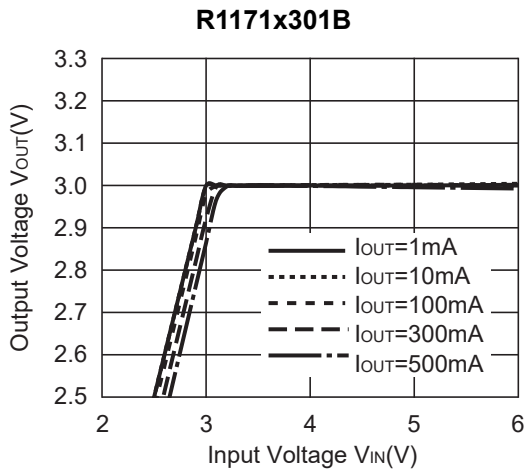
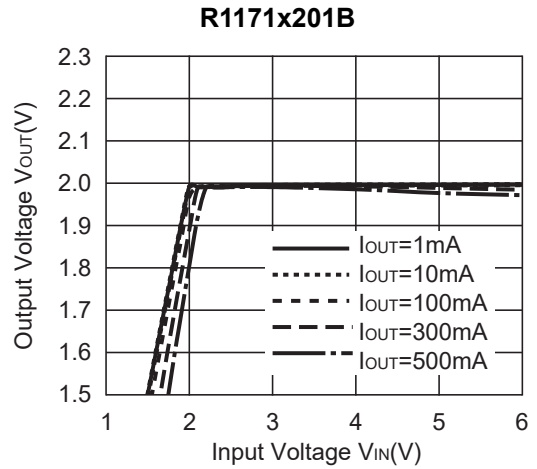
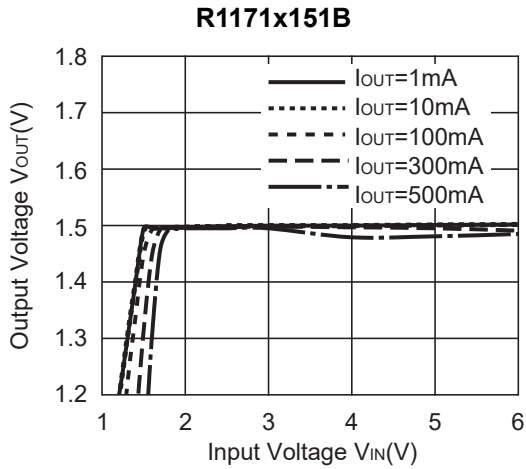

3) Dropout Voltage vs. Output Current

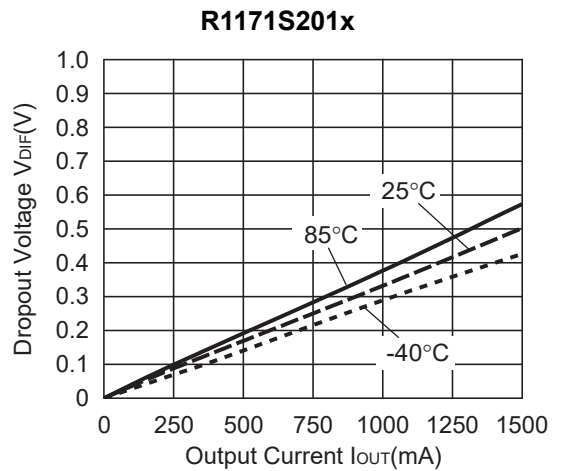
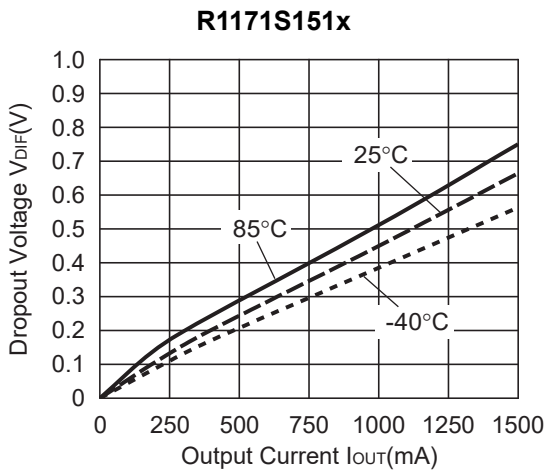

R1171S301x

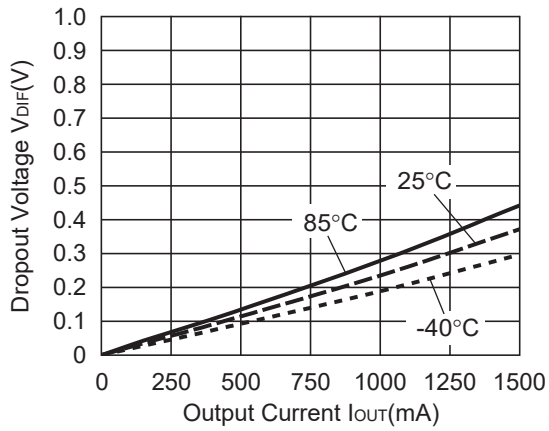

R1171S501x

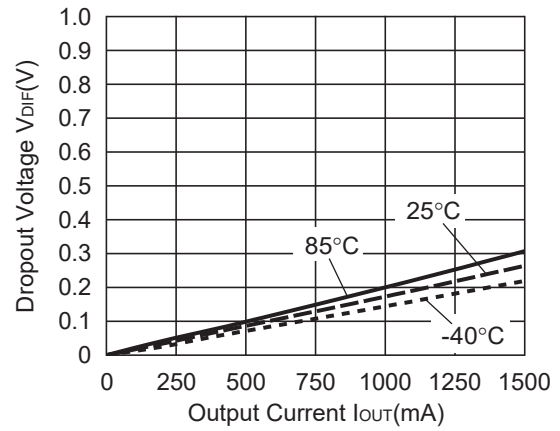

R1171J181x

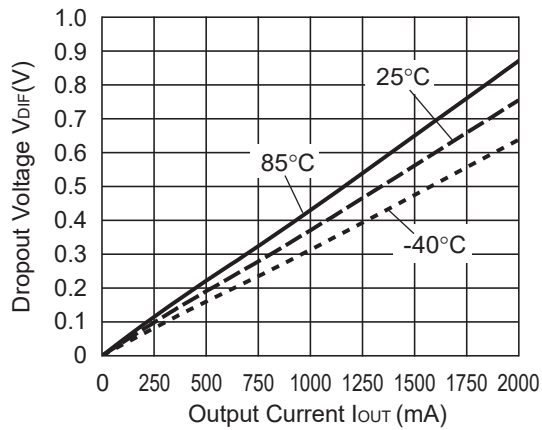

R1171J201x

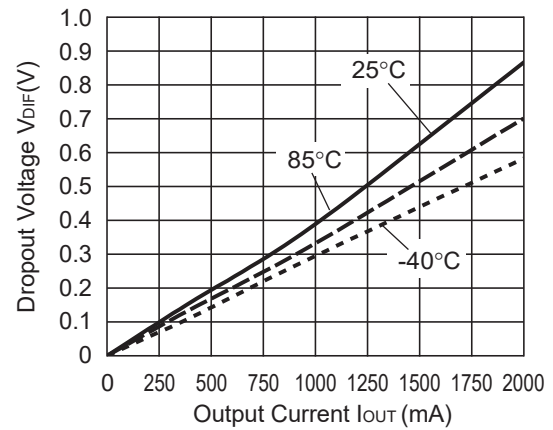

R1171J301x

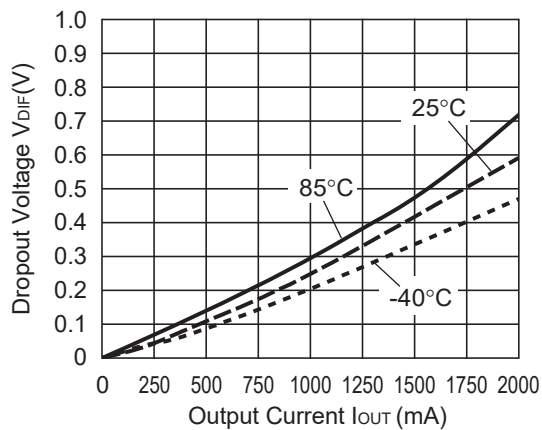

R1171J501x

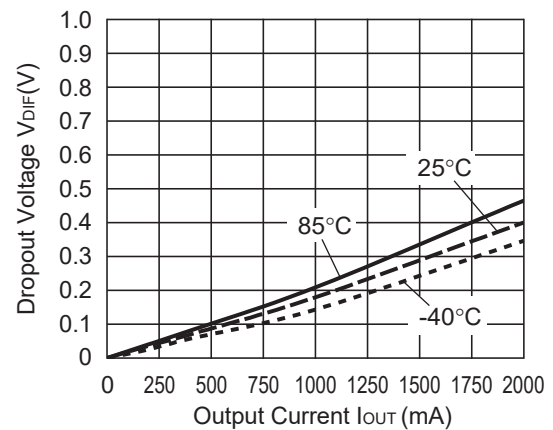

4) Output Voltage vs. Temperature

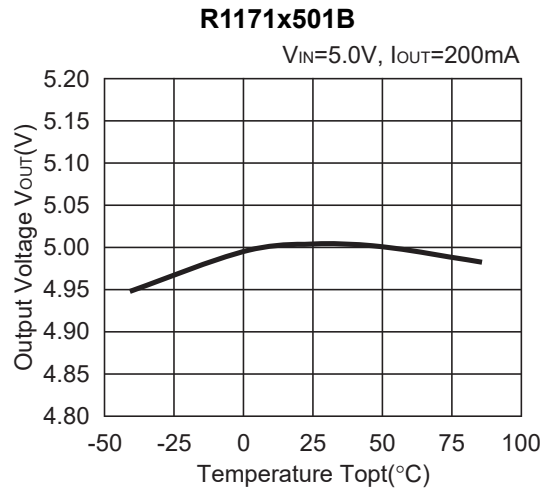
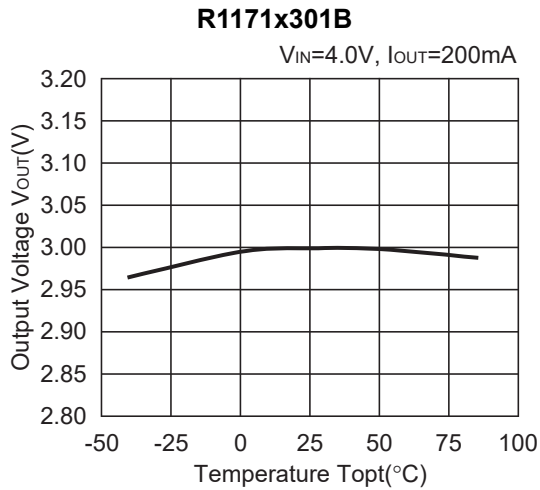
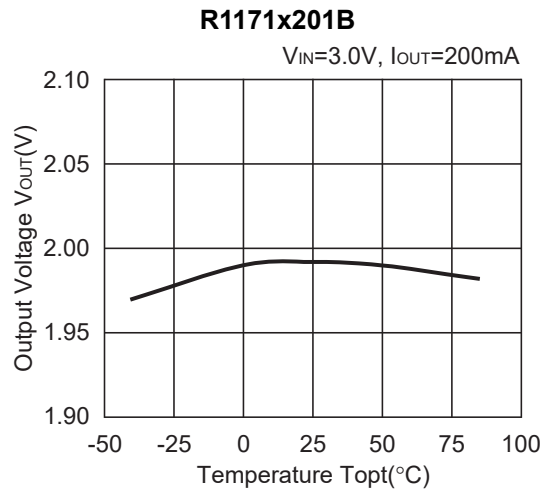
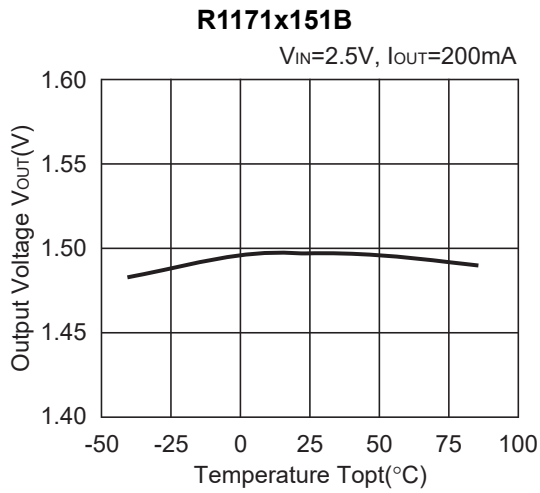

5) Supply Current vs. Input Voltage ($T_{opt}=25^{\circ}C$)

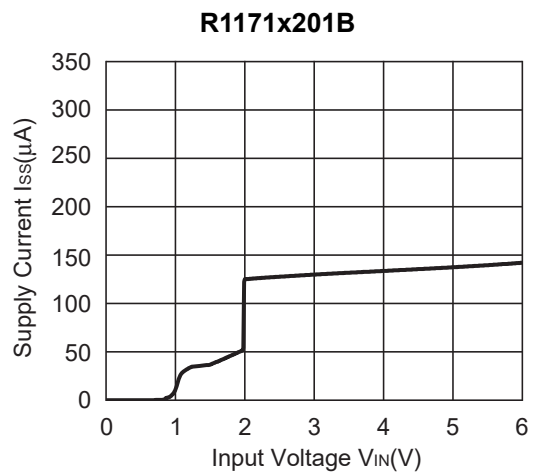
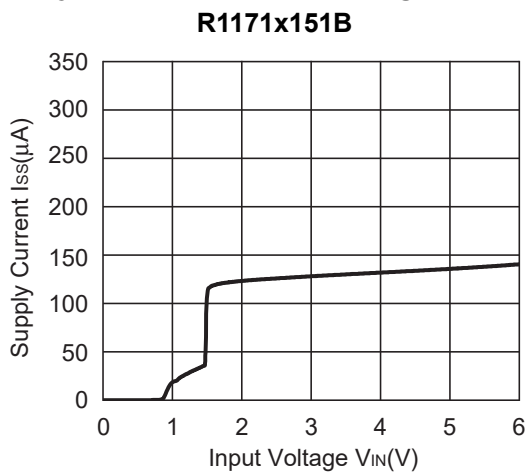

*R1171J (TO-252-5) is the discontinued product as of September 2022.

R1171x

NO. EA-125-220908

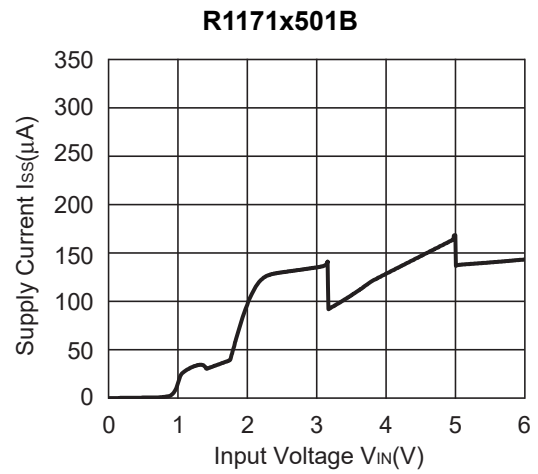
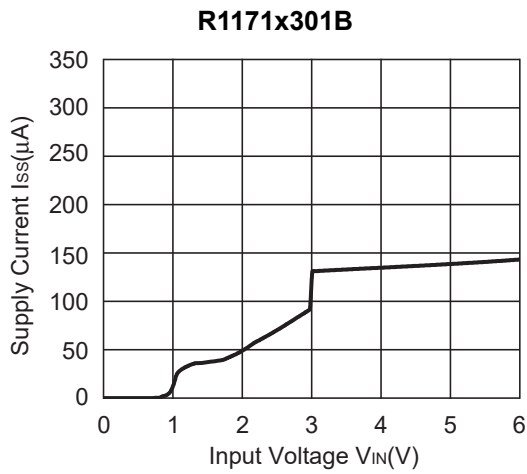

6) Supply Current vs. Temperature

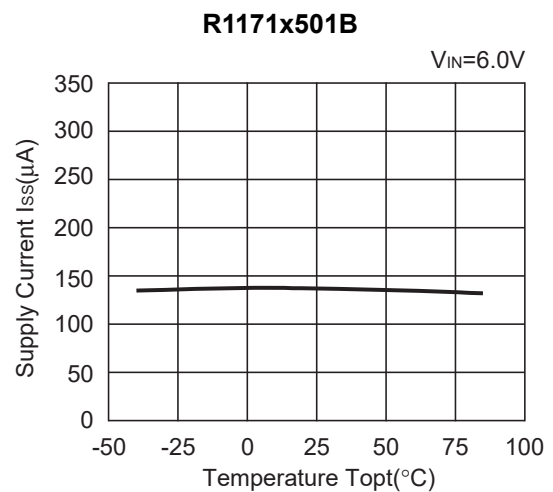
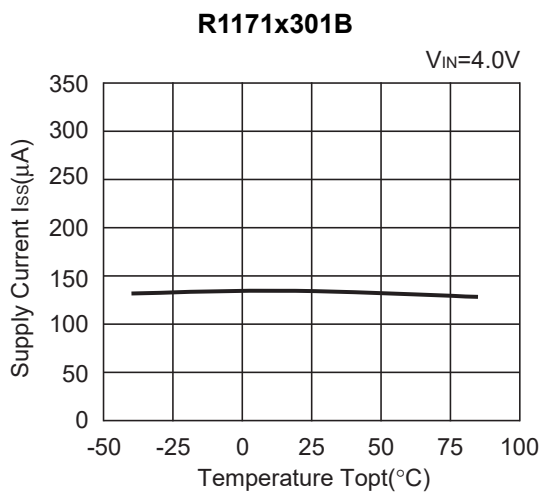
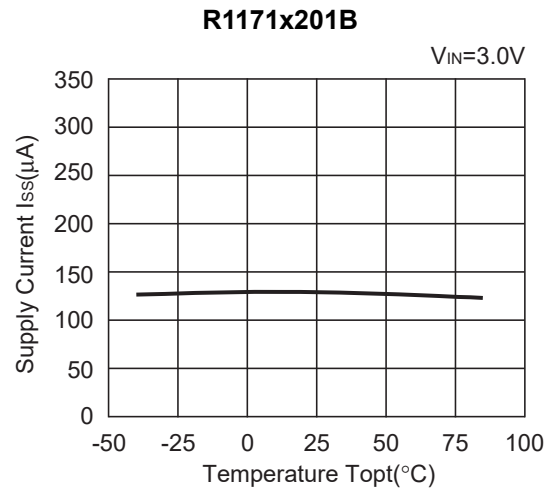
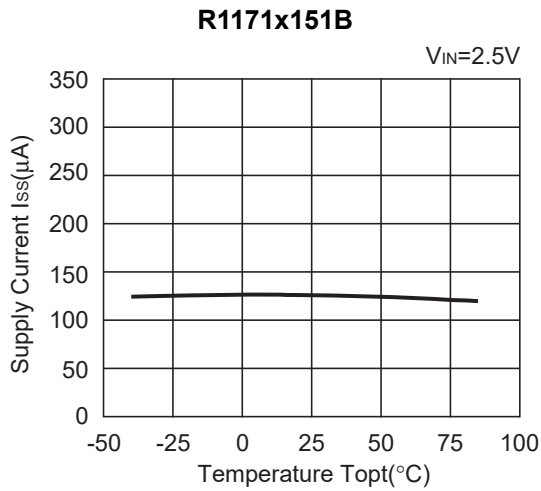

7) Dropout Voltage vs. Set Output Voltage (T_{opt}=25°C)

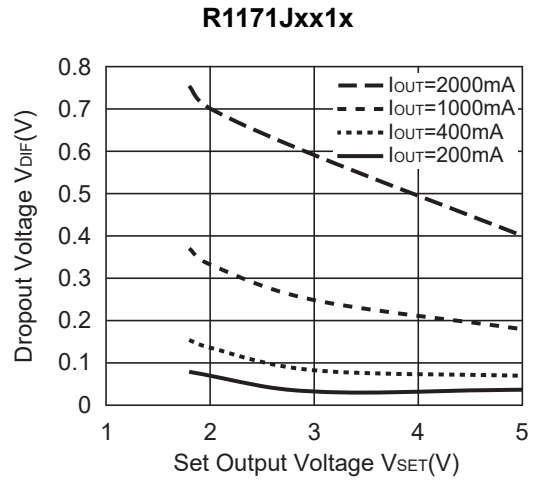
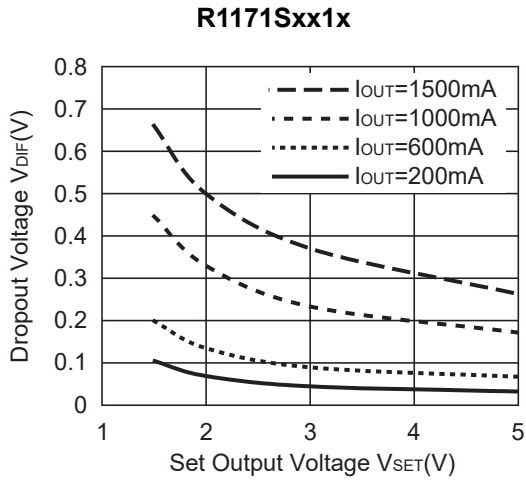

8) Ripple Rejection vs. Frequency

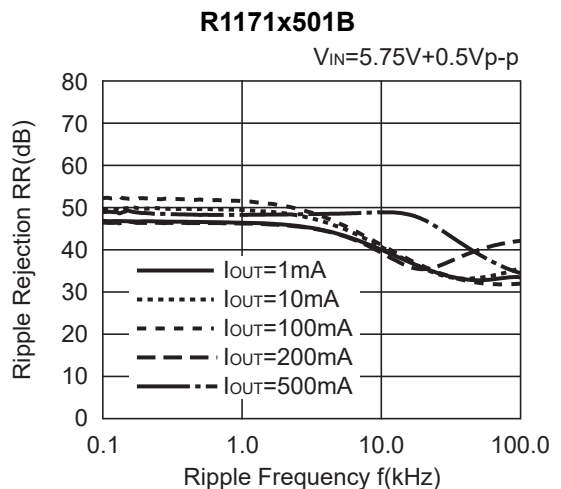
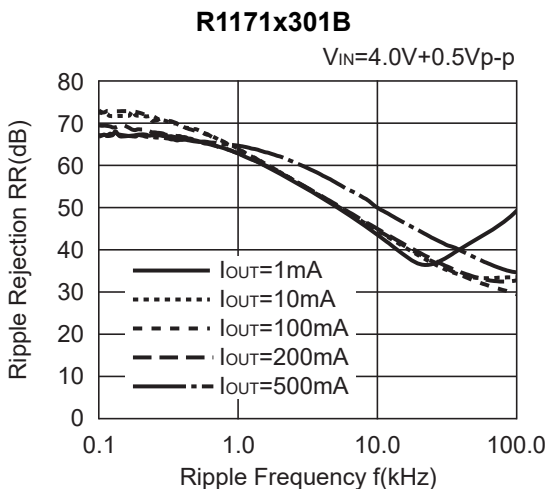
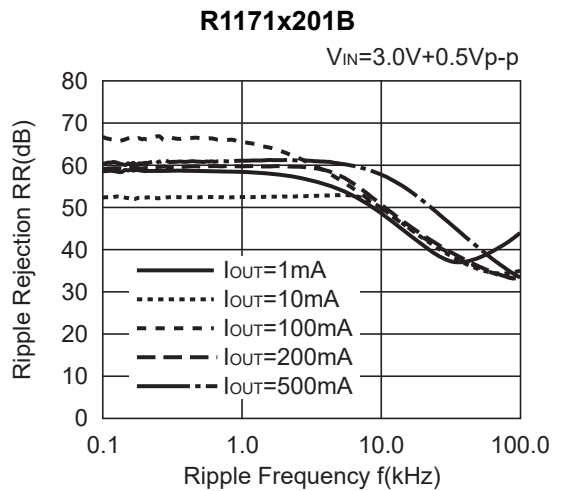
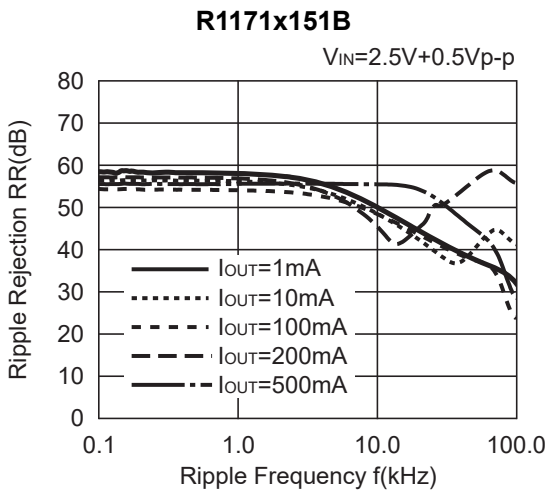

9) Ripple Rejection vs. Input Voltage

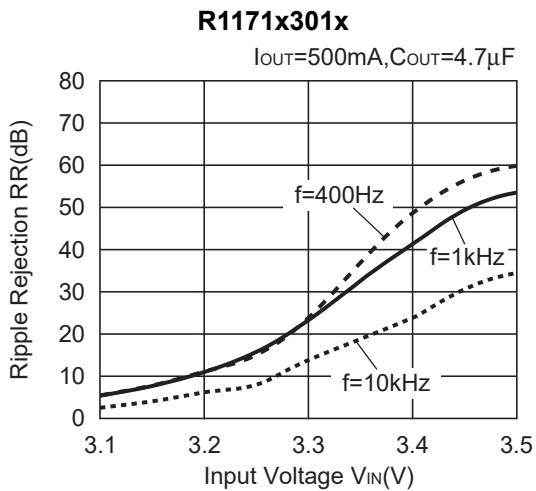
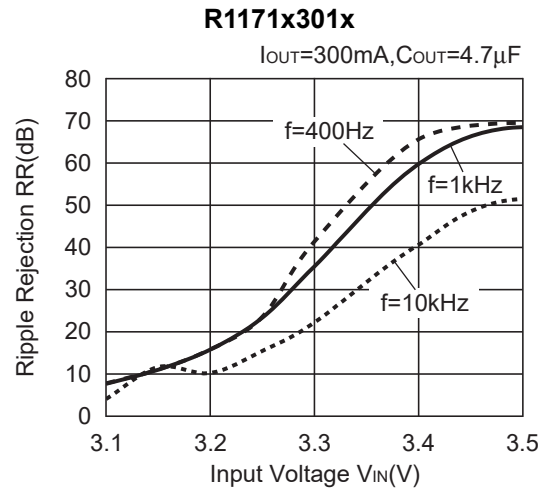
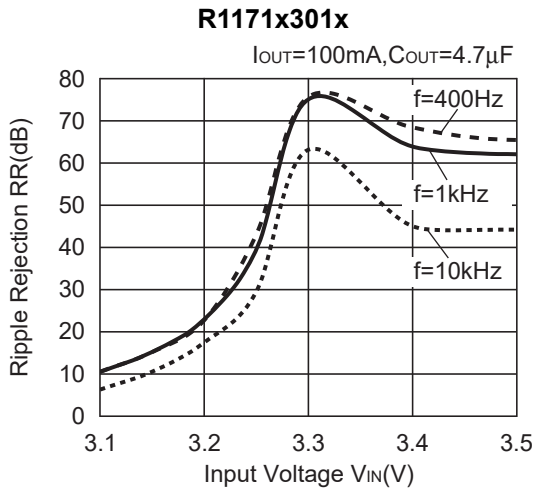
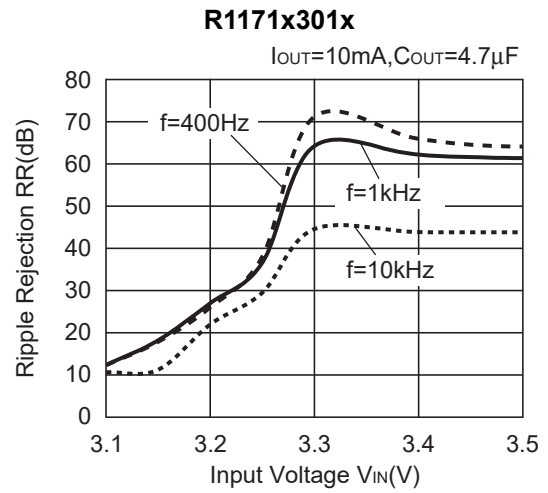
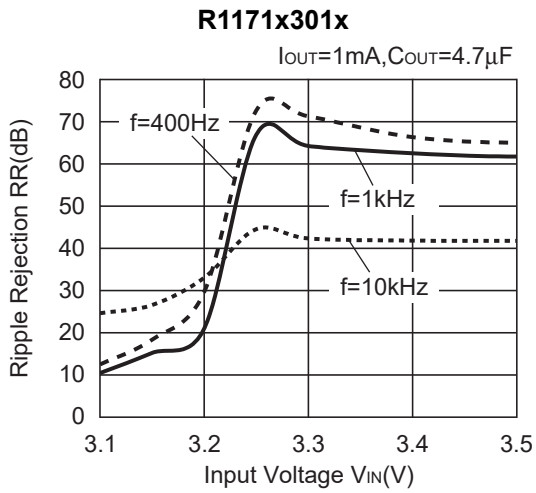

10) Input Transient Response (T_{opt}=25°C)

R1171x151B

tr=tf=5μs, I_{OUT}=1000mA, C_{OUT}=Ceramic 10μF

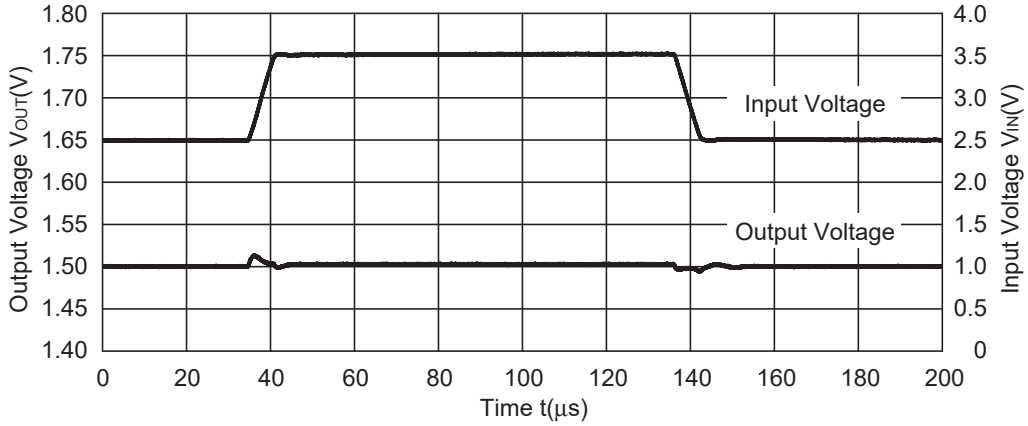

R1171x201B

tr=tf=5μs, I_{OUT}=1000mA, C_{OUT}=Ceramic 4.7μF

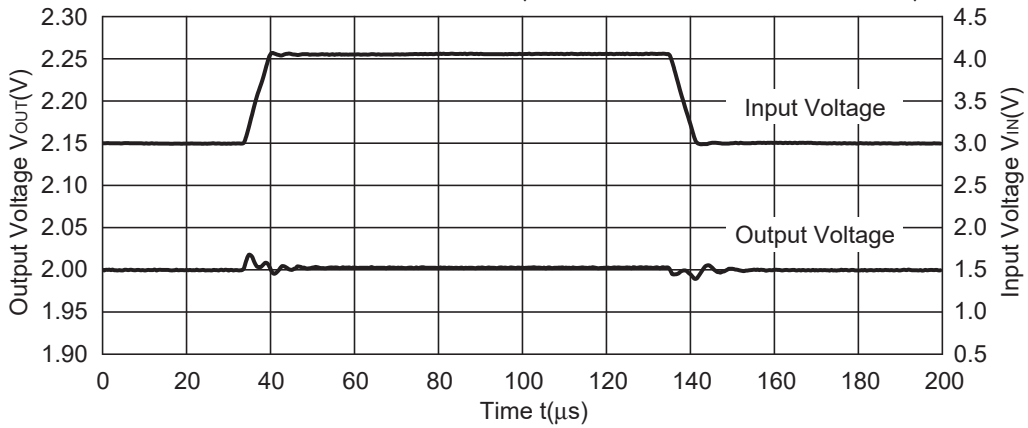

R1171x301B

tr=tf=5μs, I_{OUT}=1000mA, C_{OUT}=Ceramic 4.7μF

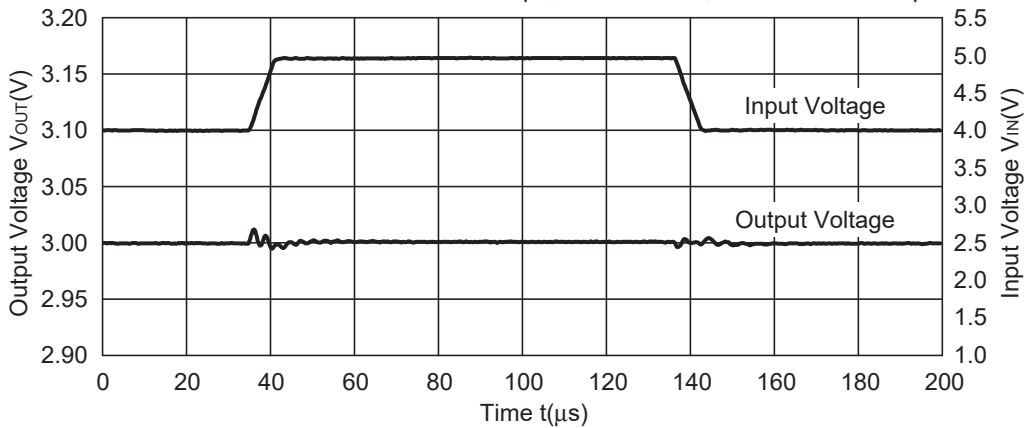

R1171x501B

$t_r=t_f=5\mu s$, $I_{OUT}=1000mA$, $C_{OUT}=\text{Ceramic } 4.7\mu F$

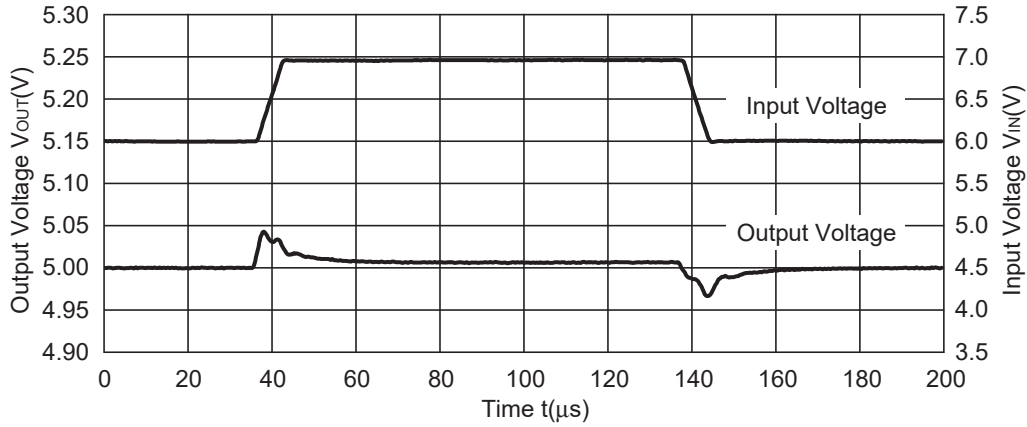

11) Load Transient Response ($T_{opt}=25^\circ C$)

R1171x151B

$t_r=t_f=10\mu s$, $V_{IN}=2.5V$, $C_{OUT}=\text{Ceramic } 10\mu F$

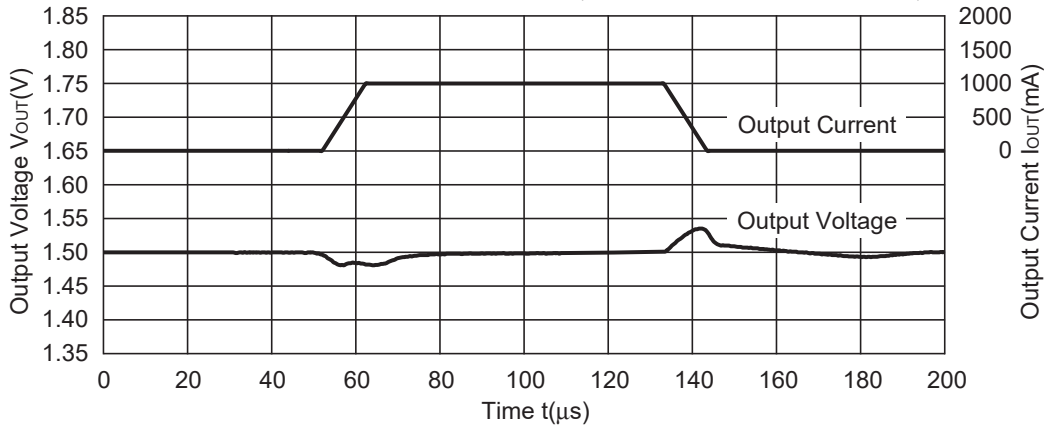

R1171x201B

$t_r=t_f=10\mu s$, $V_{IN}=3.0V$, $C_{OUT}=\text{Ceramic } 4.7\mu F$

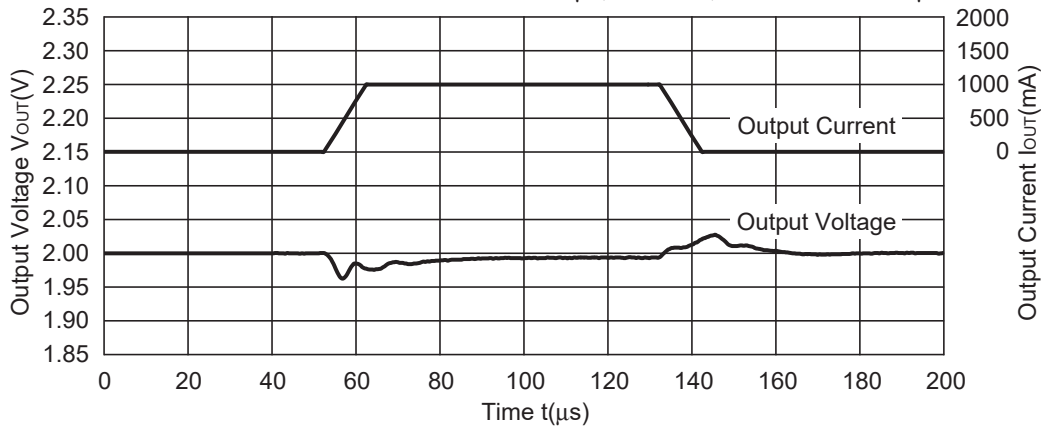

R1171x301B

$t_r=t_f=10\mu s$, $V_{IN}=4.0V$, $C_{OUT}=\text{Ceramic } 4.7\mu F$

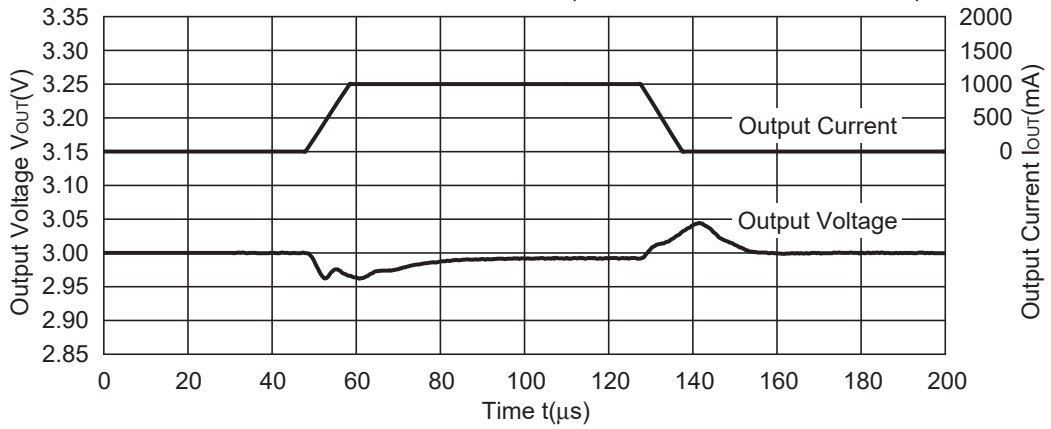

R1171x501B

$t_r=t_f=10\mu s$, $V_{IN}=6.0V$, $C_{OUT}=\text{Ceramic } 4.7\mu F$

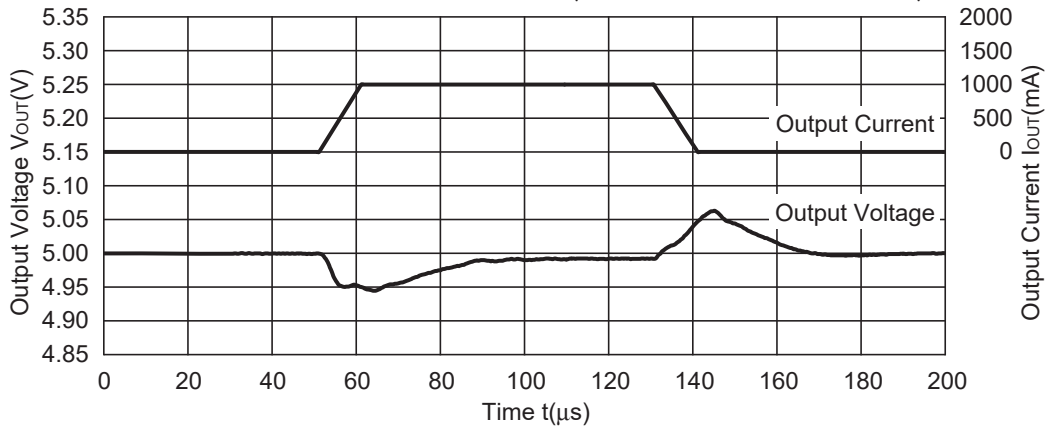

Technical Notes on External Components and Typical Application

1. Phase Compensation

In these ICs, phase compensation is made with the output capacitor for securing stable operation even if the load current is varied. For this purpose, use a capacitor with the capacitance range from $4.7\mu\text{F}$ to $10.0\mu\text{F}$, as C_L . In case that using a tantalum capacitor and the ESR of the tantalum capacitor is too large, unstable operation may result. Fully evaluation is necessary for the whole circuit with considering the frequency characteristic.

2. Mounting on PCB

Make V_{DD} and GND lines sufficient. If their impedance is high, large current may flow and the pick-up noise or unstable operation may result. Therefore use a capacitor with a capacitance range from $4.7\mu\text{F}$ to $10.0\mu\text{F}$ between V_{DD} pin and GND pin as close as possible.

Further, set an output capacitor between V_{OUT} pin and GND pin for phase compensation as close as possible. (Refer to the example of typical application)

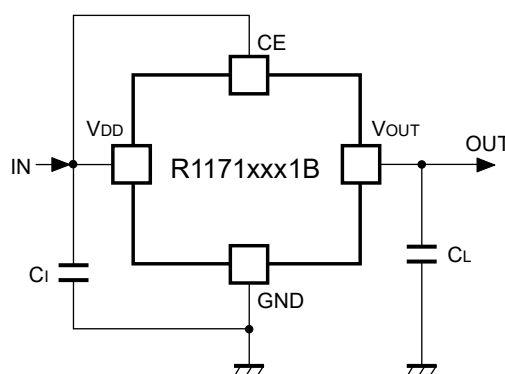

R1171Sxx1B Typical Application

$1.5\text{V} \leq V_{OUT} < 1.8\text{V}$: $C_i = 10\mu\text{F}$ (Ceramic), $C_L = 10\mu\text{F}$ (Ceramic)

$1.8\text{V} \leq V_{OUT} \leq 5.0\text{V}$: $C_i = 4.7\mu\text{F}$ (Ceramic), $C_L = 4.7\mu\text{F}$ (Ceramic)

3. Output Short Protection Function

In the R1171x Series, the output short protection function is built in, further, if the output is short to the GND or other voltage line, the chip inside is heating, as a result, in case that the junction temperature becomes equal or more than 150°C (Typ.), the built-in thermal shutdown circuit works. If the junction temperature becomes equal or more than 150°C (Typ.), the IC is protected by the output short protection circuit and the thermal shutdown circuit.

ESR vs. Output Current ($T_{opt}=25^{\circ}C$, $V_{IN}=\text{Set Output Voltage}+1V$, $C_{IN}=\text{Ceramic } 10\mu F$)

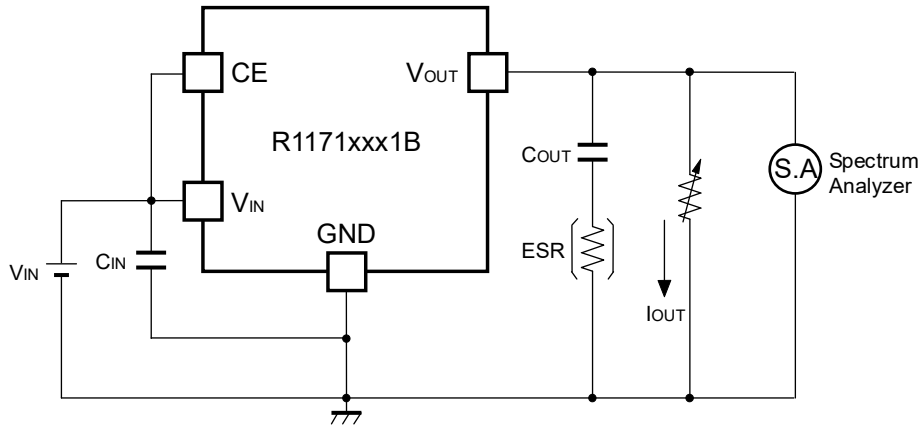

As an output capacitor for this IC, Ceramic capacitor is recommendable. However, other low ESR type capacitor can be used with this IC.

For your reference, noise level is tested with the circuit as shown above, and if the noise level is $40\mu V$ or less than $40\mu V$, the ESR values are plotted as stable area. Upper limit is described in the next four graphs, or ESR vs. Output Current. (Hatched area is the stable area.)

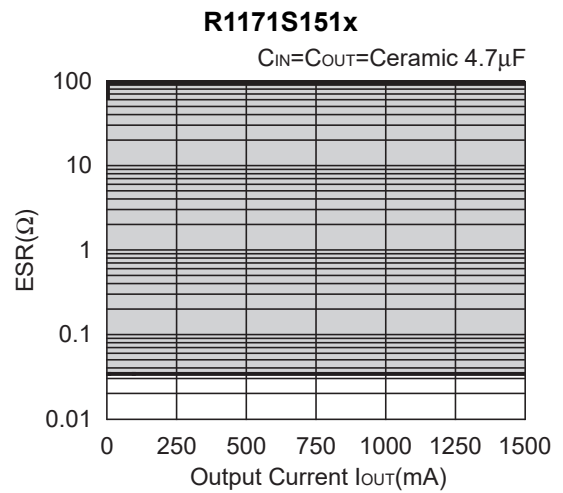
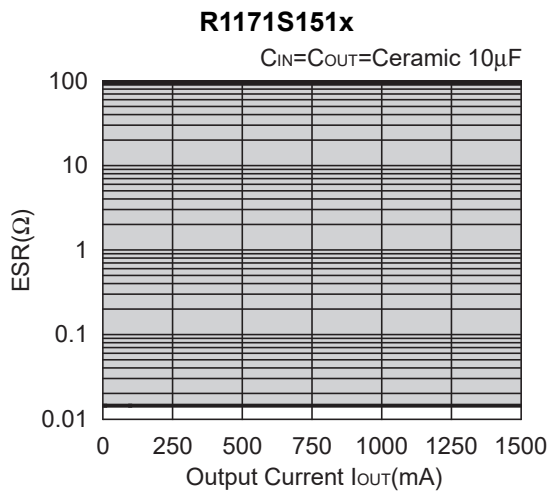

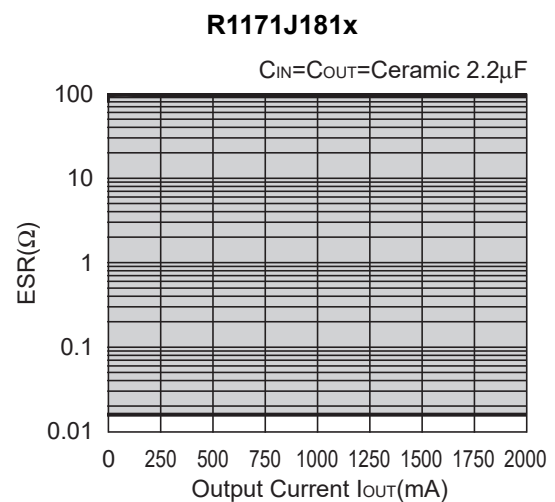
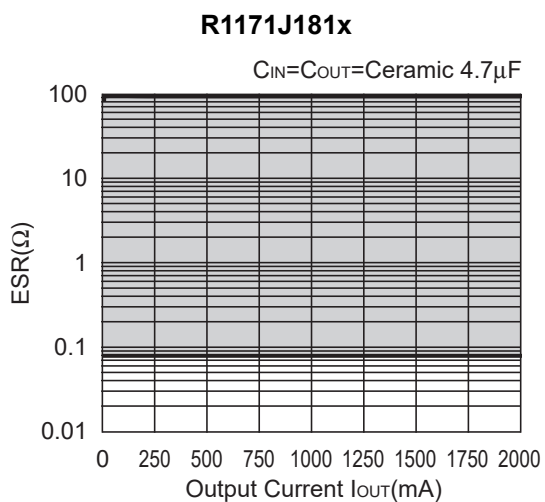
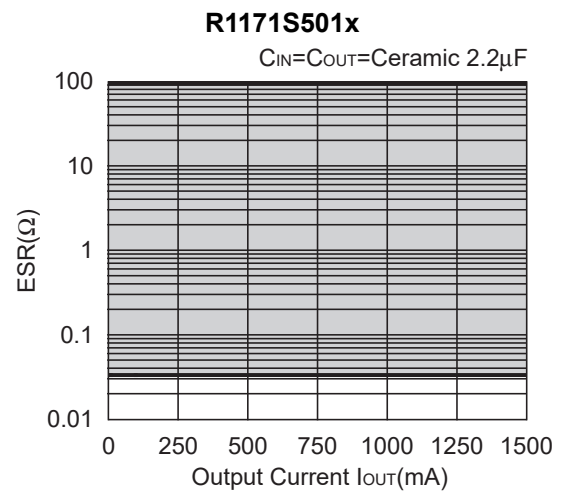
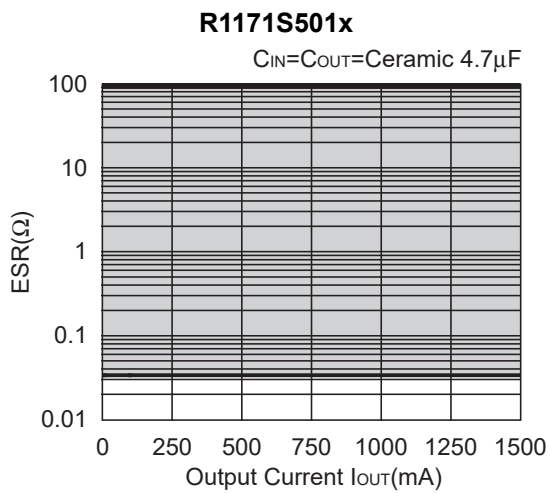
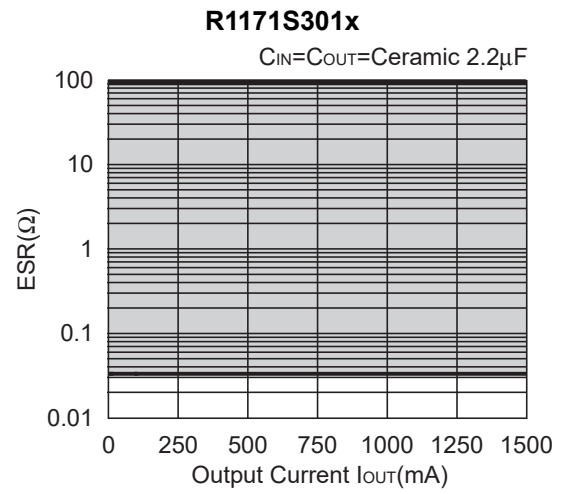
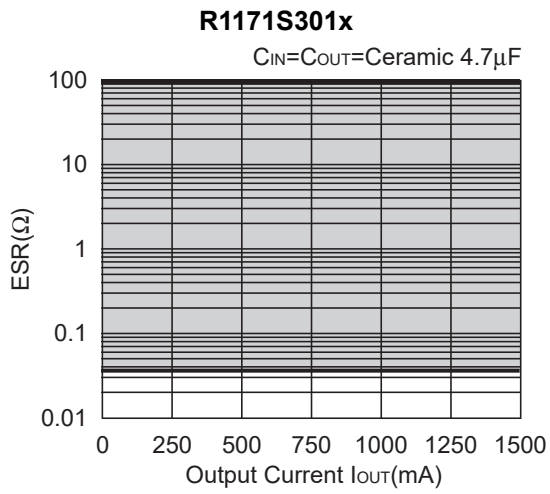

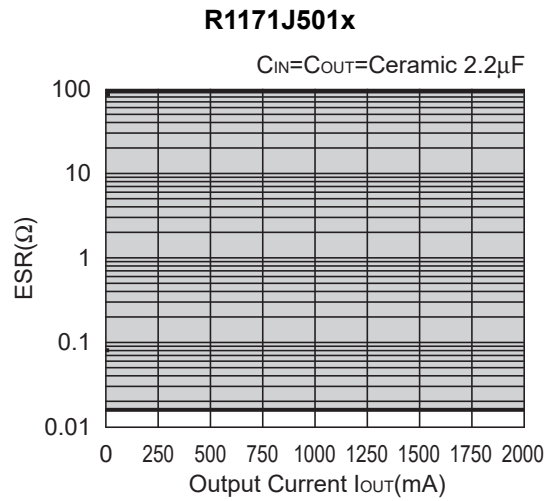
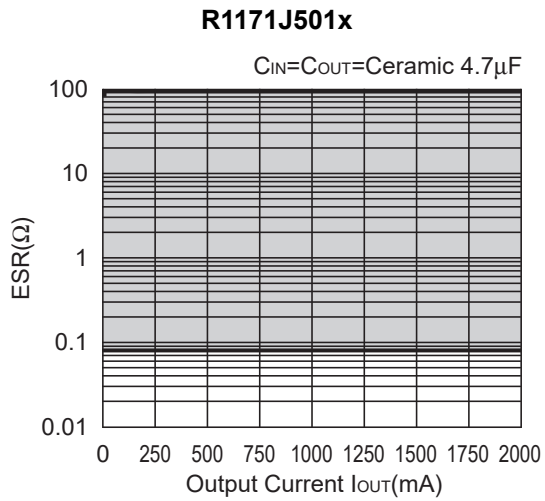
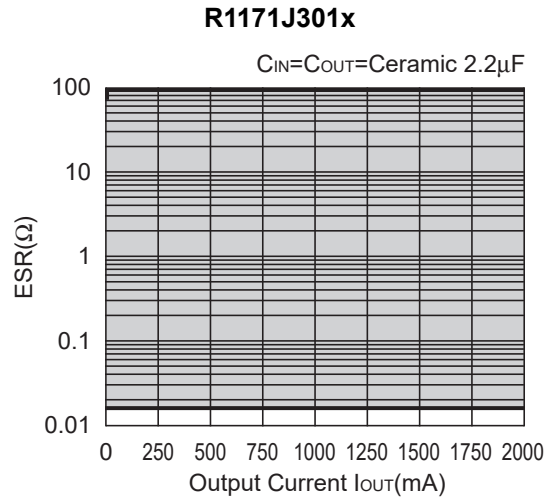
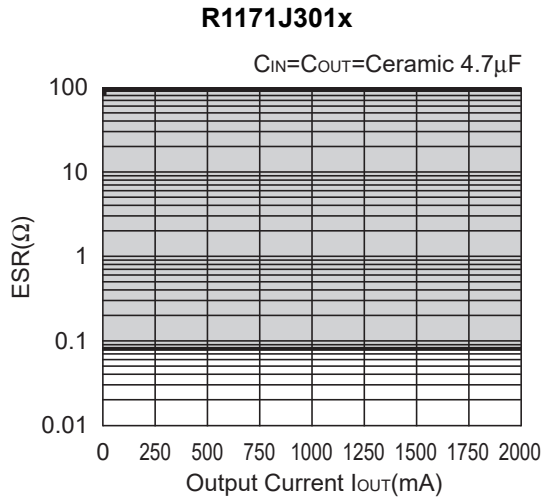

1. The products and the product specifications described in this document are subject to change or discontinuation of production without notice for reasons such as improvement. Therefore, before deciding to use the products, please refer to our sales representatives for the latest information thereon.
2. The materials in this document may not be copied or otherwise reproduced in whole or in part without the prior written consent of us.
3. This product and any technical information relating thereto are subject to complementary export controls (so-called KNOW controls) under the Foreign Exchange and Foreign Trade Law, and related politics ministerial ordinance of the law. (Note that the complementary export controls are inapplicable to any application-specific products, except rockets and pilotless aircraft, that are insusceptible to design or program changes.) Accordingly, when exporting or carrying abroad this product, follow the Foreign Exchange and Foreign Trade Control Law and its related regulations with respect to the complementary export controls.
4. The technical information described in this document shows typical characteristics and example application circuits for the products. The release of such information is not to be construed as a warranty of or a grant of license under our or any third party's intellectual property rights or any other rights.
5. The products listed in this document are intended and designed for use as general electronic components in standard applications (office equipment, telecommunication equipment, measuring instruments, consumer electronic products, amusement equipment etc.). Those customers intending to use a product in an application requiring extreme quality and reliability, for example, in a highly specific application where the failure or misoperation of the product could result in human injury or death should first contact us.
 - Aerospace Equipment
 - Equipment Used in the Deep Sea
 - Power Generator Control Equipment (nuclear, steam, hydraulic, etc.)
 - Life Maintenance Medical Equipment
 - Fire Alarms / Intruder Detectors
 - Vehicle Control Equipment (automotive, airplane, railroad, ship, etc.)
 - Various Safety Devices
 - Traffic control system
 - Combustion equipment

In case your company desires to use this product for any applications other than general electronic equipment mentioned above, make sure to contact our company in advance. Note that the important requirements mentioned in this section are not applicable to cases where operation requirements such as application conditions are confirmed by our company in writing after consultation with your company.

6. We are making our continuous effort to improve the quality and reliability of our products, but semiconductor products are likely to fail with certain probability. In order to prevent any injury to persons or damages to property resulting from such failure, customers should be careful enough to incorporate safety measures in their design, such as redundancy feature, fire containment feature and fail-safe feature. We do not assume any liability or responsibility for any loss or damage arising from misuse or inappropriate use of the products.
7. The products have been designed and tested to function within controlled environmental conditions. Do not use products under conditions that deviate from methods or applications specified in this datasheet. Failure to employ the products in the proper applications can lead to deterioration, destruction or failure of the products. We shall not be responsible for any bodily injury, fires or accident, property damage or any consequential damages resulting from misuse or misapplication of the products.
8. **Quality Warranty**
 - 8-1. **Quality Warranty Period**

In the case of a product purchased through an authorized distributor or directly from us, the warranty period for this product shall be one (1) year after delivery to your company. For defective products that occurred during this period, we will take the quality warranty measures described in section 8-2. However, if there is an agreement on the warranty period in the basic transaction agreement, quality assurance agreement, delivery specifications, etc., it shall be followed.
 - 8-2. **Quality Warranty Remedies**

When it has been proved defective due to manufacturing factors as a result of defect analysis by us, we will either deliver a substitute for the defective product or refund the purchase price of the defective product.

Note that such delivery or refund is sole and exclusive remedies to your company for the defective product.
 - 8-3. **Remedies after Quality Warranty Period**

With respect to any defect of this product found after the quality warranty period, the defect will be analyzed by us. On the basis of the defect analysis results, the scope and amounts of damage shall be determined by mutual agreement of both parties. Then we will deal with upper limit in Section 8-2. This provision is not intended to limit any legal rights of your company.
9. Anti-radiation design is not implemented in the products described in this document.
10. The X-ray exposure can influence functions and characteristics of the products. Confirm the product functions and characteristics in the evaluation stage.
11. WLCSP products should be used in light shielded environments. The light exposure can influence functions and characteristics of the products under operation or storage.
12. Warning for handling Gallium and Arsenic (GaAs) products (Applying to GaAs MMIC, Photo Reflector). These products use Gallium (Ga) and Arsenic (As) which are specified as poisonous chemicals by law. For the prevention of a hazard, do not burn, destroy, or process chemically to make them as gas or power. When the product is disposed of, please follow the related regulation and do not mix this with general industrial waste or household waste.
13. Please contact our sales representatives should you have any questions or comments concerning the products or the technical information.



Nisshinbo Micro Devices Inc.

Official website

<https://www.nisshinbo-microdevices.co.jp/en/>

Purchase information

<https://www.nisshinbo-microdevices.co.jp/en/buy/>