



PCB terminal, Eccentric, No. of poles: 15, Width: 112.5 mm, Colour: Green

### Business data

Article number	<u>10607.1</u>
Article name	PKT 2200/15/7,50-V GN
GTIN (EAN)	4044211011789
Packaging unit	50
Quantity unit	PC
Packaging type	Carton
Type of banding	Without
Weight per piece (not including packaging)	61.98 g
Weight per piece (including packaging)	62.98 g
Unit of weight	G
Customs number	85369010
Country of origin	QU
Colour	Green

---

### Technical data

---

#### Dimensions

Length	18.5 mm
Length of the pin	3.5 mm
Width	112.5 mm
Width left	2.8 mm
Width right	4.7 mm
Height	19.5 mm
Drill hole diameter	1.3 mm
Diameter of connecting pin	0.8 mm
Pitch	7.5 mm

#### Ratings

Rated voltage	450 V
Rated current	24 A
Rated cross-section	2.5 mm <sup>2</sup>
Rated impulse voltage	2.5 kV
Overvoltage category	III
Contamination degree	3

### Technical data

#### Connection data

Connection principle	Eccentric
Connection type of PCB	Solder connection
Type of attachment to circuit board	Connecting contact
Angle of PCB/wire connection	90° (vertically upwards)
No. of poles	15
Number of levels	1
Wire cross-section single-core (rigid) / stranded, min.	0.2 mm <sup>2</sup>
Wire cross-section single core (rigid)/stranded, max.	4 mm <sup>2</sup>
Wire cross-section stranded, min.	0.2 mm <sup>2</sup>
Wire cross-section stranded, max.	2.5 mm <sup>2</sup>
Wire cross-section stranded with wire-end ferrules,min.	0.25 mm <sup>2</sup>
Wire cross-section stranded with wire-end ferrules,max.	2.5 mm <sup>2</sup>
Wire cross-section AWG, min.	30
Wire cross-section AWG, max.	12
Stripping length	9 mm
Screw threading	M 2,5
Torque	0.5 Nm

#### Materials

Insulation housing	Polyamide 6.6
Flammability class UL 94	V-0
Working temperature, min.	-30 °C
Working temperature, max.	105 °C
Eccentric	Steel
Clamping cage	Steel
Screws	Steel
Soldering lug	Copper alloy

### Technical data

#### Further technical data

Storage temperature, min.	-40 °C
Storage temperature, max.	105 °C
Insulation resistance	1*10 <sup>13</sup> Ohm x cm
Creepage-current resistance	CTI 600
Glow wire flammability index GWFI	GWFI 850
GWFI after-glow time	30 Sek.
Glow wire ignition temperature GWIT	GWIT 775 °C
GWIT exposure time	5 Sek.
Connection cycles, in compliance with standard	5
Recommended wave soldering temperature	265 °C
Recommended wave soldering duration, min.	3 Sek.
Recommended wave soldering duration, max.	4 Sek.

#### Environmental Product Compliance

REACH Conform	No
REACH Reference date	2023-06-14
REACH Candidate Substance Note	No
REACH CAS 1 Substance	LEAD
REACH CAS 1 Percent minimal	0.1 %
REACH CAS 1 Percent maximum	4 %
REACH CAS 1 Number	7439-92-1
RoHS Conform	yes
RoHS Exception rule	6c

### Approvals

#### cUL Recognized

cUL approval	CSA 22.2 No.158
cUL Usegroup B: rated voltage	300 V
cUL Usegroup B: rated current	20 A
cUL Usegroup C: rated voltage	150 V
cUL Usegroup C: rated current	20 A
cUL Usegroup D: rated voltage	300 V
cUL Usegroup D: rated current	10 A
cUL wire cross-section single-core (rigid) AWG, min.	30
cUL wire cross-section single-core (rigid) AWG, max.	12
cUL wire cross-section stranded AWG, min.	30
cUL wire cross-section stranded AWG, max.	12
cUL torque	0.5 Nm
cUL wire material	Cu
cUL Recognized	1

#### UL Recognized

UL approval	UL 1059
UL Usegroup B: rated voltage	300 V
UL Usegroup B: rated current	20 A
UL Usegroup C: rated voltage	150 V
UL Usegroup C: rated current	20 A
UL Usegroup D: rated voltage	300 V
UL Usegroup D: rated current	10 A
UL wire cross-section single-core (rigid) AWG, min.	30
UL wire cross-section single-core (rigid) AWG, max.	12
UL wire cross-section stranded AWG, min.	30
UL wire cross-section stranded AWG, max.	12
UL wire material	Cu
UL factory wiring	1
UL field wiring	1
UL Recognized	1

### Approvals

#### VDE approval

VDE approval	DIN EN 60998
VDE approval granted	yes
VDE rated voltage	450 V
VDE rated current	24 A
VDE rated current wire cross-section rigid, max.	24 A
VDE rated current wire cross-section stranded, max.	24 A
VDE rated impulse voltage	2.5 kV
VDE wire cross-section rigid, min.	0.5 mm <sup>2</sup>
VDE wire cross-section rigid, max.	2.5 mm <sup>2</sup>
VDE wire cross-section stranded, min.	0.5 mm <sup>2</sup>
VDE wire cross-section stranded, max.	2.5 mm <sup>2</sup>
VDE screw threading	M 2,5
VDE torque	0.5 Nm
VDE overvoltage category	III
VDE contamination degree	3

### Media

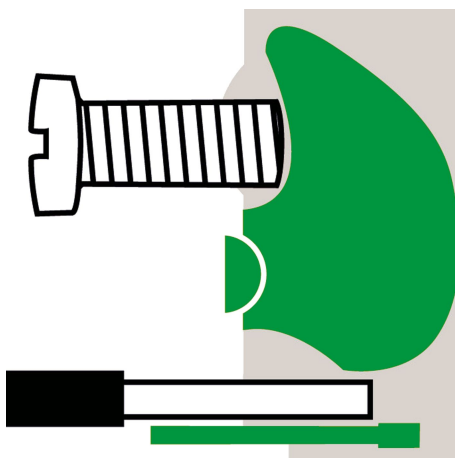
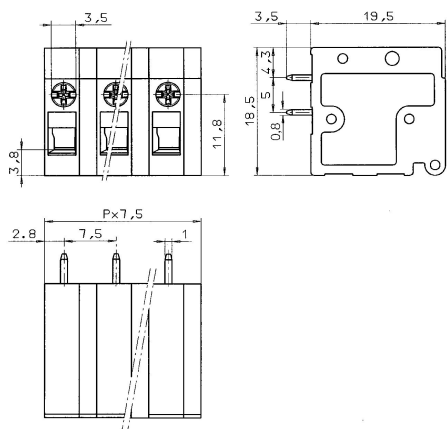

**M2.5**



**C  US**



---

### Accessories

---