

LOW NOISE 300mA LDO REGULATOR

NO.EA-141-160705

OUTLINE

The RP102x Series are CMOS-based voltage regulator ICs with high output voltage accuracy, extremely low supply current, low ON-resistance, and high ripple rejection. Each of these ICs consists of a voltage reference unit, an error amplifier, a resistor-net for voltage setting, a current limit circuit and a chip enable circuit.

These ICs perform with low dropout voltage and "chip enable" function. The line transient response and load transient response of the RP102x Series are excellent, thus these ICs are very suitable for the power supply for hand-held communication equipment.

The output voltage of these ICs is fixed with high accuracy. Since the packages for these ICs are SOT-23-5, DFN(PL)1820-6, and WLCSP-4-P2, therefore high density mounting of the ICs on boards is possible.

FEATURES

- Supply Current Typ. 50 μ A
- Standby Mode Typ. 0.1 μ A
- Dropout Voltage Typ. 0.12V ($I_{OUT}=300mA$, $V_{OUT}=2.8V$)
- Ripple Rejection Typ. 80dB ($f=1kHz$)
- Temperature-Drift Coefficient of Output Voltage ... Typ. $\pm 20ppm/^{\circ}C$
- Line Regulation Typ. 0.02%/V
- Output Voltage Accuracy $\pm 0.8\%$
- Packages WLCSP-4-P2, DFN(PL)1820-6, SOT-23-5
- Input Voltage Range 1.7V to 5.25V
- Output Voltage Range 1.2V to 3.3V (0.1V steps)
(For other voltages, please refer to MARK INFORMATION.)
- Built-in Fold Back Protection Circuit Typ. 50mA (Current at short mode)
- Ceramic capacitors are recommended to be used with this IC $C_{IN}=C_{OUT}=1\mu F$ or more

APPLICATIONS

- Power source for portable communication equipment.
- Power source for electrical appliances such as cameras, VCRs and camcorders.
- Power source for battery-powered equipment.

RP102x

NO.EA-141-160705

BLOCK DIAGRAMS

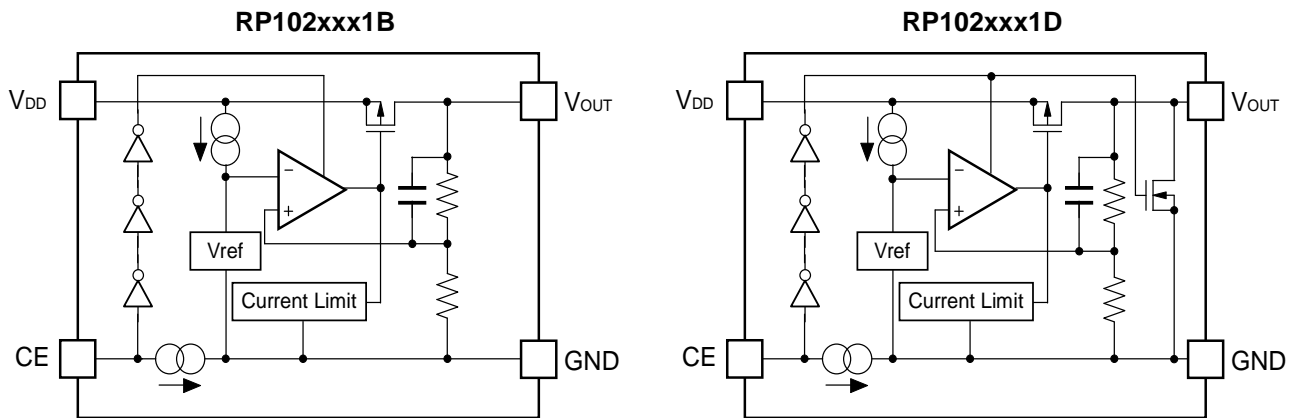

SELECTION GUIDE

The output voltage, auto discharge function, package, and the taping type, etc. for the ICs can be selected at the user's request.

Product Name	Package	Quantity per Reel	Pb Free	Halogen Free
RP102Zxx1*-TR-F	WLCSP-4-P2	5,000 pcs	Yes	Yes
RP102Kxx1*-TR	DFN(PL)1820-6	5,000 pcs	Yes	Yes
RP102Nxx1*-TR-FE	SOT-23-5	3,000 pcs	Yes	Yes

xx: The output voltage can be designated in the range from 1.2V(12) to 3.3V(33) in 0.1V steps.
(For other voltages, please refer to MARK INFORMATIONS.)

* : CE pin polarity and auto discharge function at off state are options as follows.
(B) "H" active, without auto discharge function at off state
(D) "H" active, with auto discharge function at off state

PIN CONFIGURATIONS

• WLCSP-4-P2

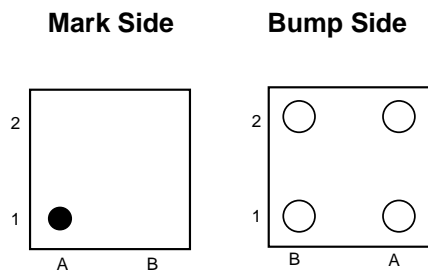

• DFN(PL)1820-6

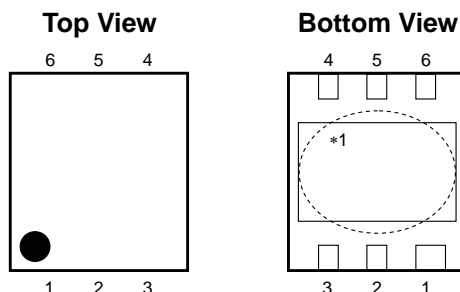

• SOT-23-5

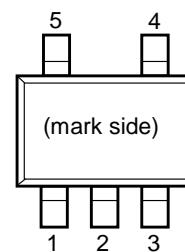

PIN DESCRIPTION

• WLCSP-4-P2

Pin No	Symbol	Pin Description
A1	V _{DD}	Input Pin
A2	V _{OUT}	Output Pin
B1	CE	Chip Enable Pin ("H" Active)
B2	GND	Ground Pin

• DFN(PL)1820-6

Pin No	Symbol	Pin Description
1	V _{OUT}	Output Pin*2
2	V _{OUT}	Output Pin*2
3	GND	Ground Pin
4	CE	Chip Enable Pin ("H" Active)
5	V _{DD}	Input Pin*2
6	V _{DD}	Input Pin*2

*1) Tab is GND level. (They are connected to the reverse side of this IC.)

The tab is better to be connected to the GND, but leaving it open is also acceptable.

*2) No.1 pin and No.2 pin, No.5 pin and No.6 pin of DFN(PL)1820-6 package must be wired when it is mounted on board.

• SOT-23-5

Pin No	Symbol	Pin Description
1	V _{DD}	Input Pin
2	GND	Ground Pin
3	CE	Chip Enable Pin ("H" Active)
4	NC	No Connection
5	V _{OUT}	Output Pin

ABSOLUTE MAXIMUM RATINGS

Symbol	Item	Rating	Unit
V_{IN}	Input Voltage	6.0	V
V_{CE}	Input Voltage (CE Pin)	6.0	V
V_{OUT}	Output Voltage	-0.3 to $V_{IN}+0.3$	V
I_{OUT}	Output Current	400	mA
P_D	Power Dissipation (WLCSP-4-P2) *	530	mW
	Power Dissipation (SOT-23-5) *	420	
	Power Dissipation (DFN(PL)1820-6) *	880	
T_{opt}	Operating Temperature Range	-40 to 85	°C
T_{stg}	Storage Temperature Range	-55 to 125	°C

*) For Power Dissipation, please refer to PACKAGE INFORMATION.

ABSOLUTE MAXIMUM RATINGS

Electronic and mechanical stress momentarily exceeded absolute maximum ratings may cause the permanent damages and may degrade the life time and safety for both device and system using the device in the field.

The functional operation at or over these absolute maximum ratings is not assured.

RECOMMENDED OPERATING CONDITIONS (ELECTRICAL CHARACTERISTICS)

All of electronic equipment should be designed that the mounted semiconductor devices operate within the recommended operating conditions. The semiconductor devices cannot operate normally over the recommended operating conditions, even if when they are used over such conditions by momentary electronic noise or surge.

And the semiconductor devices may receive serious damage when they continue to operate over the recommended operating conditions.

ELECTRICAL CHARACTERISTICS

• RP102xxx1B/D

V_{IN} =Set $V_{OUT}+1V$ for V_{OUT} options grater than 1.5V. $V_{IN}=2.5V$ for $V_{OUT} \leq 1.5V$.

$I_{OUT}=1mA$, $C_{IN}=C_{OUT}=1\mu F$, unless otherwise noted.

$T_{opt}=25^{\circ}C$

Symbol	Item	Conditions	Min.	Typ.	Max.	Unit	
V_{OUT}	Output Voltage	$V_{IN}=\text{Set } V_{OUT}+1V$	$V_{OUT} > 2.0V$	$\times 0.992$		$\times 1.008$	V
			$V_{OUT} \leq 2.0V$	-16		+16	mV
I_{OUT}	Output Current		300			mA	
$\frac{\Delta V_{OUT}}{\Delta I_{OUT}}$	Load Regulation	$1mA \leq I_{OUT} \leq 150mA$		10	20	mV	
		$1mA \leq I_{OUT} \leq 300mA$		20	40		
V_{DIF}	Dropout Voltage	Refer to the following table					
I_{SS}	Supply Current	$I_{OUT}=0mA$		50	70	μA	
$I_{standby}$	Supply Current (Standby)	$V_{CE}=0V$		0.1	2.0	μA	
$\Delta V_{OUT}/\Delta V_{IN}$	Line Regulation	Set $V_{OUT}+0.5V \leq V_{IN} \leq 5V$		0.02	0.10	%/V	
RR	Ripple Rejection	$f=1kHz$, Ripple 0.2Vp-p $V_{IN}=\text{Set } V_{OUT}+1V$, $I_{OUT}=30mA$ (In case that $V_{OUT} \leq 2V$, $V_{IN}=3V$)		80		dB	
V_{IN}	Input Voltage*		1.7		5.25	V	
$\Delta V_{OUT}/\Delta T_{opt}$	Output Voltage Temperature Coefficient	$-40^{\circ}C \leq T_{opt} \leq 85^{\circ}C$		± 20		ppm/ $^{\circ}C$	
I_{SC}	Short Current Limit	$V_{OUT}=0V$		50		mA	
I_{PD}	CE Pull-down Current		0.05	0.3	0.6	μA	
V_{CEH}	CE Input Voltage "H"		1.1			V	
V_{CEL}	CE Input Voltage "L"				0.3	V	
en	Output Noise	$BW=10Hz$ to $100kHz$, $I_{OUT}=30mA$		30		μV_{rms}	
R_{LOW}	Low Output Nch Tr. ON Resistance (of D version)	$V_{IN}=4V$ $V_{CE}=0V$		30		Ω	

*) The maximum Input Voltage of the ELECTRICAL CHARACTERISTICS is 5.25V. In case of exceeding this specification, the IC must be operated on condition that the Input Voltage is up to 5.5V and the total operating time is within 500hrs.

• Electrical Characteristics by Output Voltage

$T_{opt}=25^{\circ}C$

Output Voltage V_{OUT} (V)	Dropout Voltage V_{DIF} (V)					
	Condition	Typ.	Max.	Condition	Typ.	Max.
$1.2V \leq V_{OUT} < 1.5V$	$I_{OUT}=150mA$	0.145	-	$I_{OUT}=300mA$	0.290	0.500
$1.5V \leq V_{OUT} < 1.7V$		0.110	0.160		0.220	0.320
$1.7V \leq V_{OUT} < 2.0V$		0.100	0.140		0.200	0.280
$2.0V \leq V_{OUT} < 2.5V$		0.085	0.120		0.170	0.240
$2.5V \leq V_{OUT} < 2.8V$		0.070	0.100		0.140	0.200
$2.8V \leq V_{OUT} \leq 3.3V$		0.060	0.095		0.120	0.190

TYPICAL APPLICATION

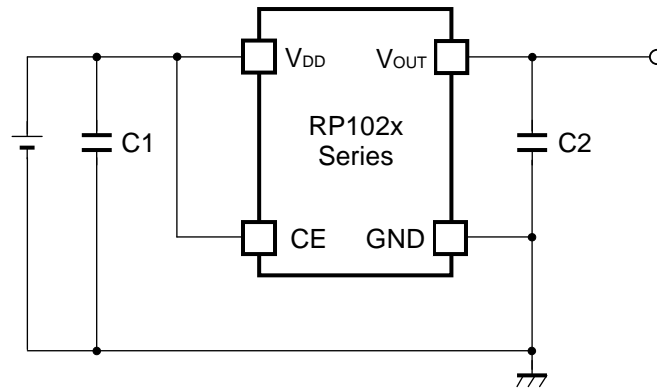

(External Components)

C2 1.0 μ F MURATA: GRM155B31A105KE15

TECHNICAL NOTES

When using these ICs, consider the following points:

Phase Compensation

In these ICs, phase compensation is made for securing stable operation even if the load current is varied. For this purpose, use a capacitor C2 with good frequency characteristics and ESR (Equivalent Series Resistance). (Note: If additional ceramic capacitors are connected with parallel to the output pin with an output capacitor for phase compensation, the operation might be unstable. Because of this, test these ICs with as same external components as ones to be used on the PCB.)

PCB Layout

Make V_{DD} and GND lines sufficient. If their impedance is high, noise pickup or unstable operation may result. Connect a capacitor C1 with a capacitance value as much as 1.0 μ F or more between V_{DD} and GND pin, and as close as possible to the pins.

Set external components, especially the output capacitor C2, as close as possible to the ICs, and make wiring as short as possible.

TEST CIRCUITS

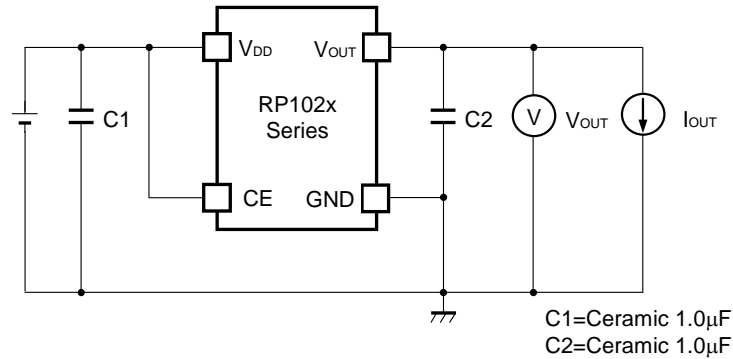

Basic Test Circuit

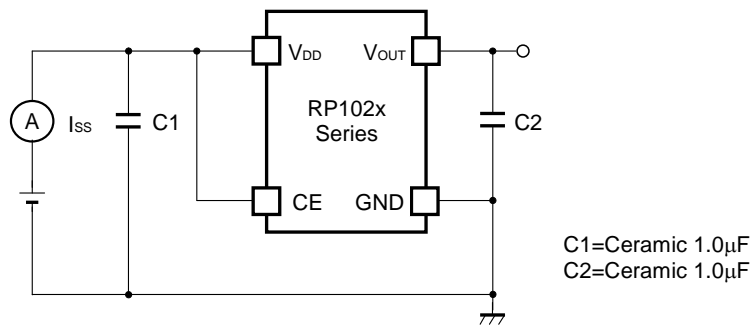

Test Circuit for Supply Current

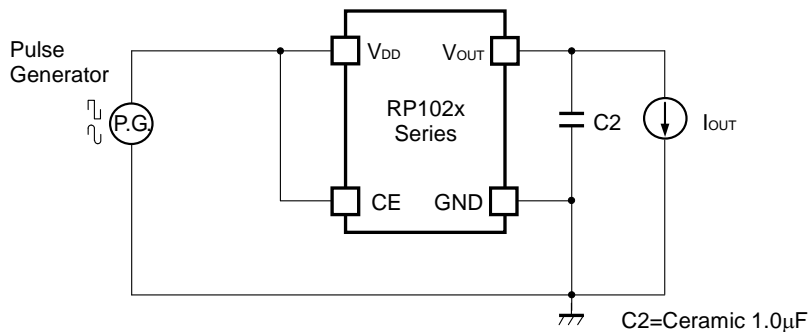

Test Circuit for Ripple Rejection

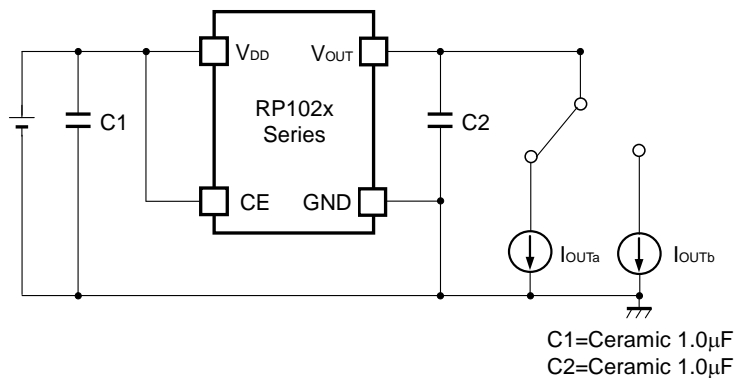

Test Circuit for Load Transient Response

RP102x

NO.EA-141-160705

TYPICAL CHARACTERISTIC

1) Output Voltage vs. Output Current ($C_{IN}=1.0\mu F$, $C_{OUT}=1.0\mu F$, $T_{opt}=25^\circ C$)

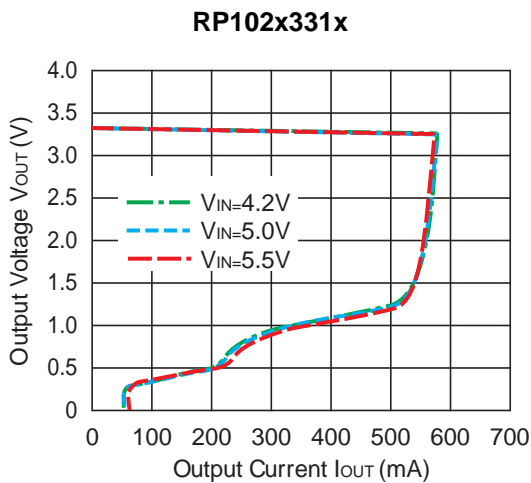
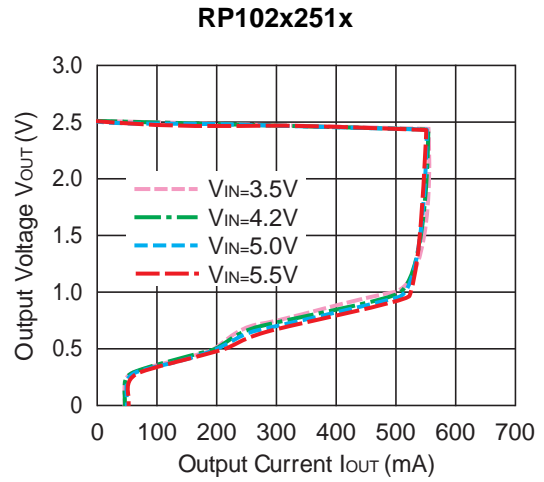
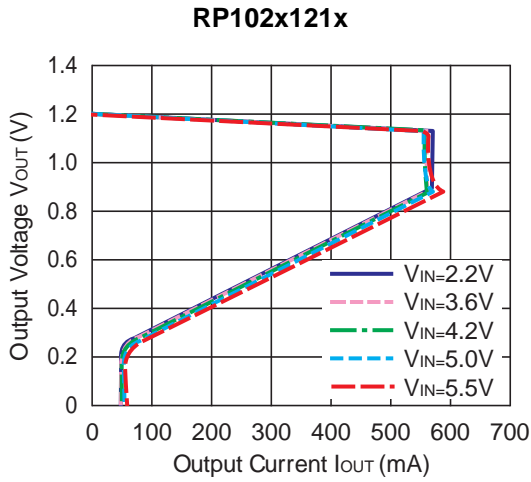

2) Output Voltage vs. Input Voltage ($C_{IN}=1.0\mu F$, $C_{OUT}=1.0\mu F$, $T_{opt}=25^\circ C$)

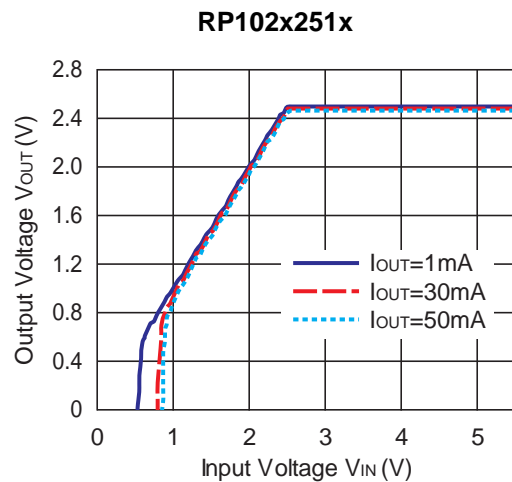
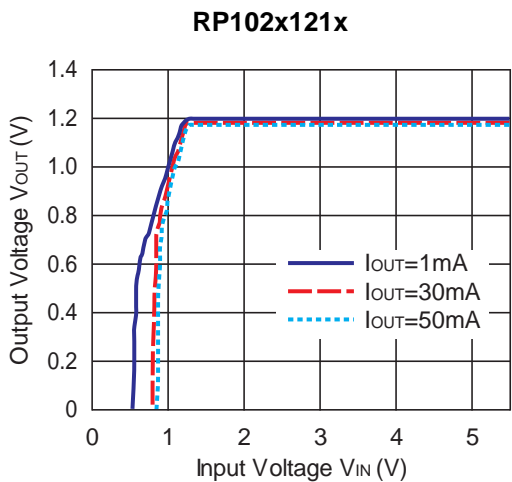

RP102x331x

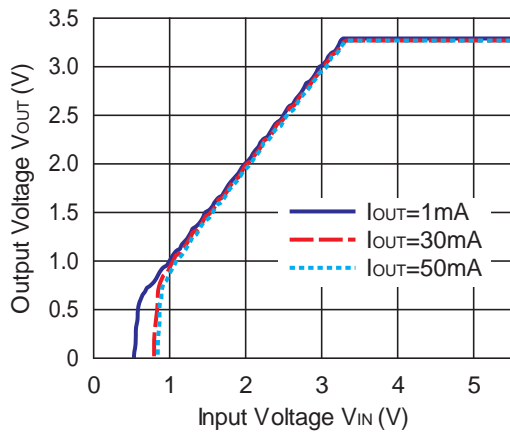

3) Supply Current vs. Input Voltage ($C_{IN}=1.0\mu F$, $C_{OUT}=1.0\mu F$, $T_{opt}=25^{\circ}C$)

RP102x121x

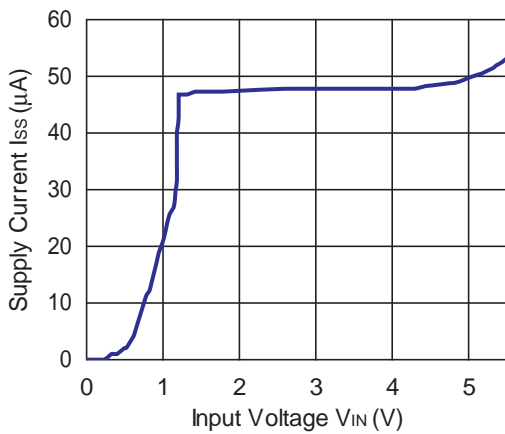

RP102x251x

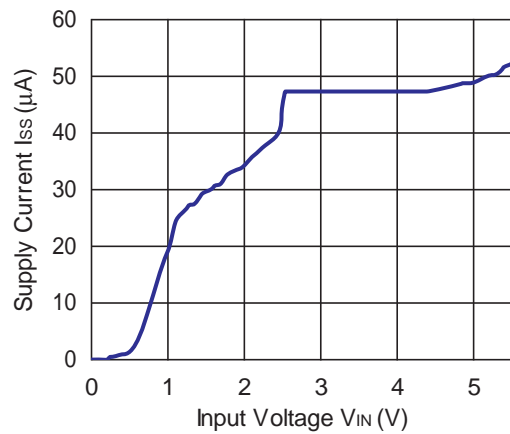

RP102x331x

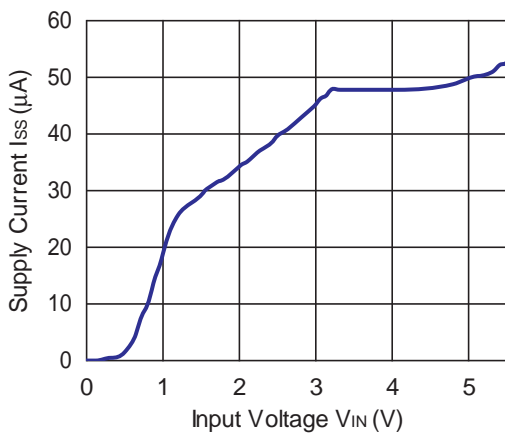

RP102x

NO.EA-141-160705

4) Output Voltage vs. Temperature ($C_{IN}=1.0\mu F$, $C_{OUT}=1.0\mu F$, $I_{OUT}=1mA$)

RP102x121x

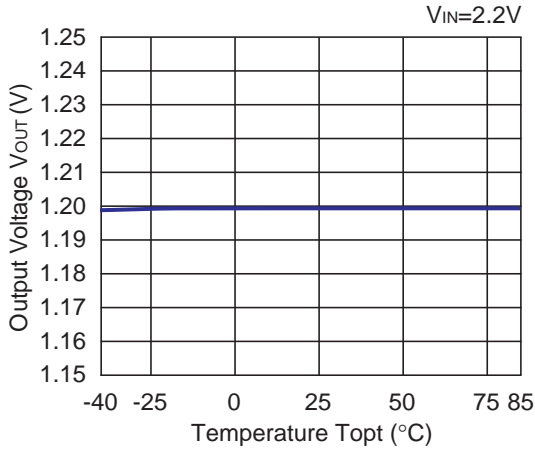

RP102x251x

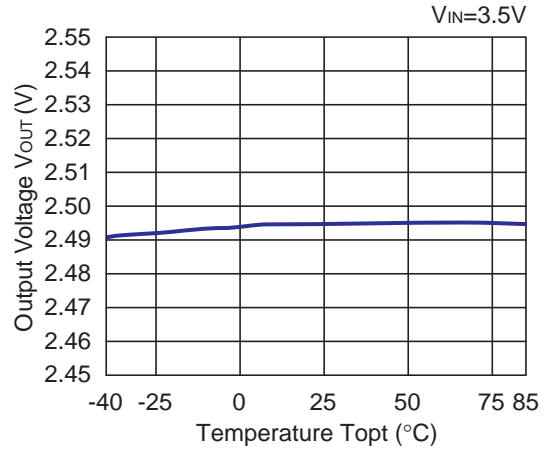

RP102x331x

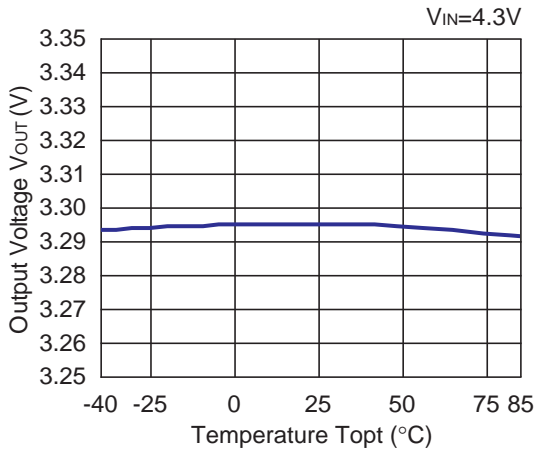

5) Supply Current vs. Temperature ($C_{IN}=1.0\mu F$, $C_{OUT}=1.0\mu F$, $I_{OUT}=0mA$)

RP102x121x

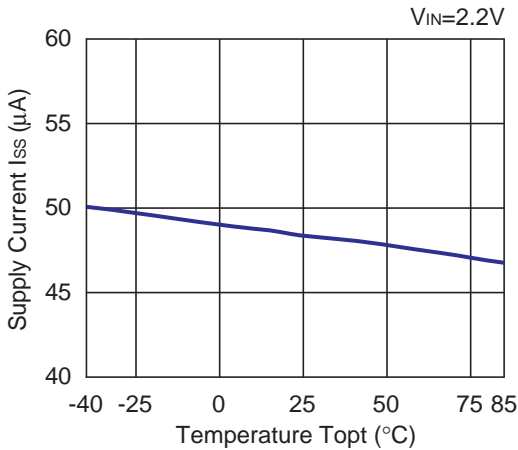

RP102x251x

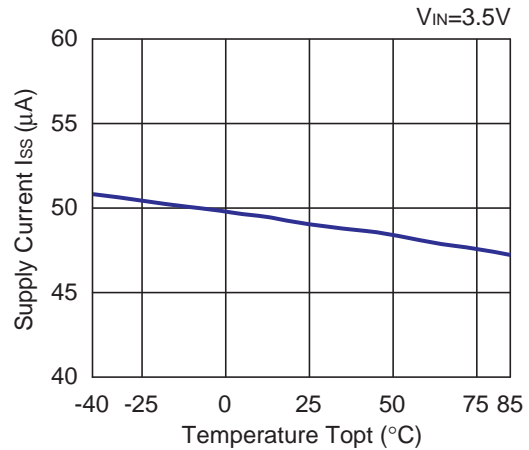

RP102x331x

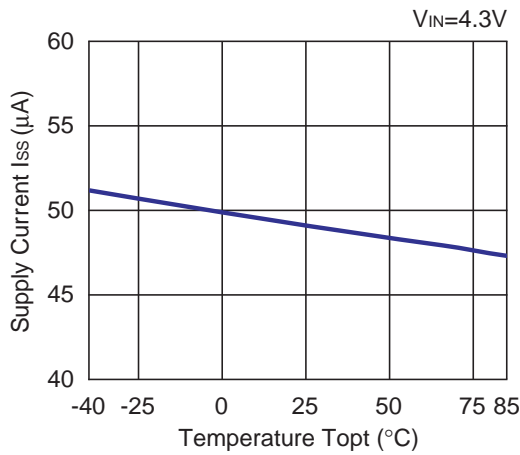

6) Dropout Voltage vs. Output Current ($C_{IN}=1.0\mu F$, $C_{OUT}=1.0\mu F$)

RP102x121x

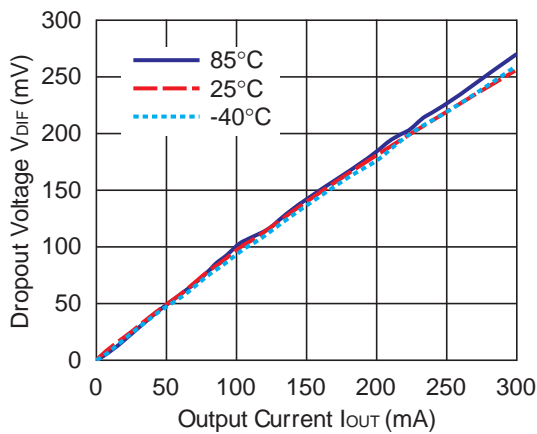

RP102x251x

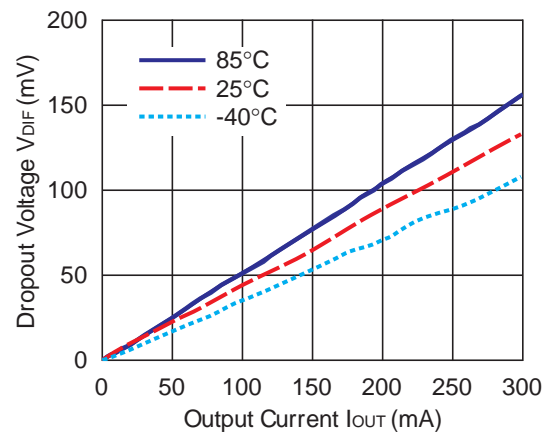

RP102x331x

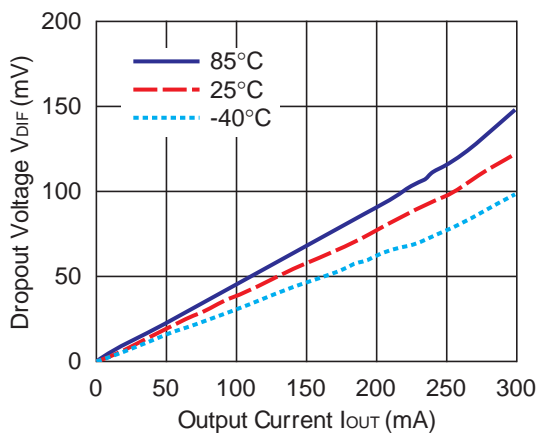

RP102x

NO.EA-141-160705

7) Dropout Voltage vs Set Output Voltage ($C_{IN}=1.0\mu F$, $C_{OUT}=1.0\mu F$, $T_{opt}=25^\circ C$)

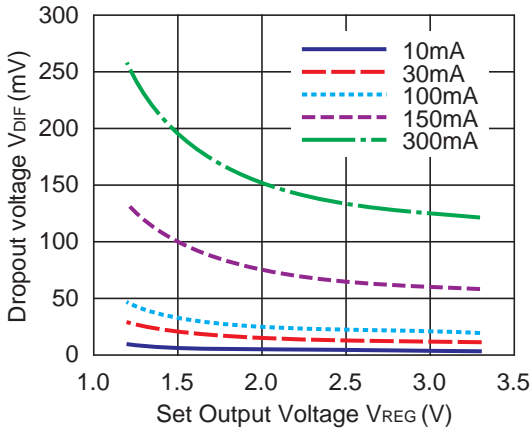

8) Ripple Rejection vs. Input Bias Voltage ($C_{IN}=none$, $C_{OUT}=1.0\mu F$, $Ripple=0.2Vp-p$, $T_{opt}=25^\circ C$)

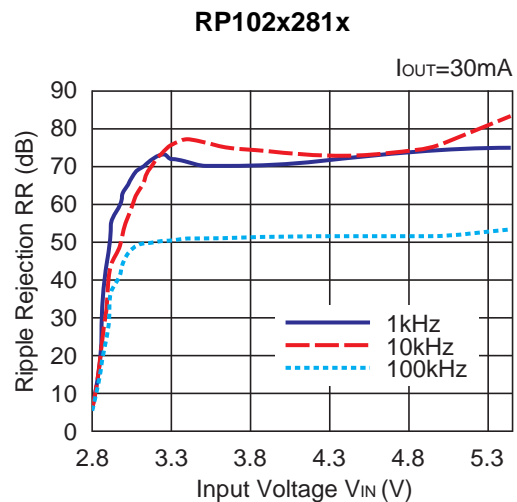
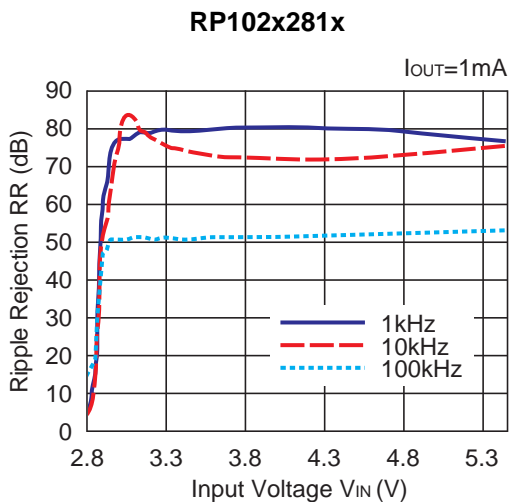
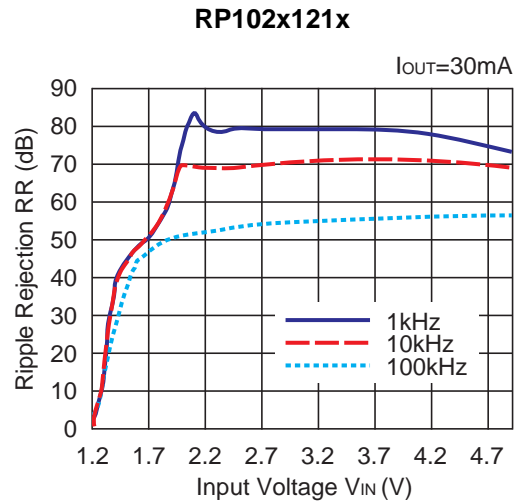
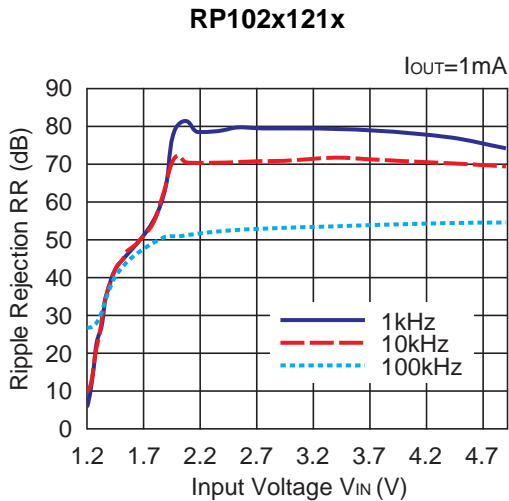

9) Ripple Rejection vs. Frequency ($C_{IN}=1.0\mu F$, $C_{OUT}=1.0\mu F$, Ripple=0.2Vp-p)

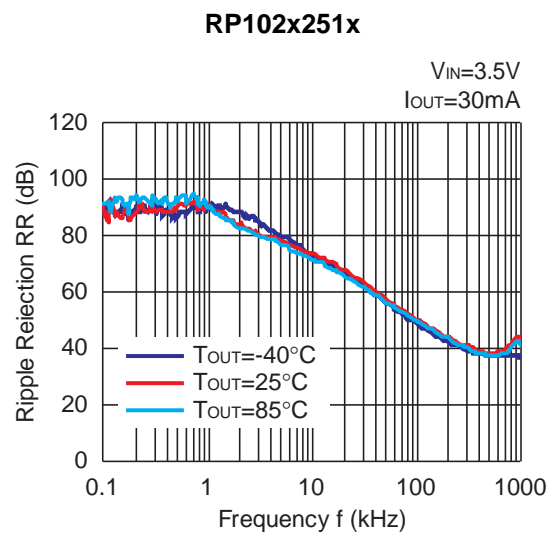
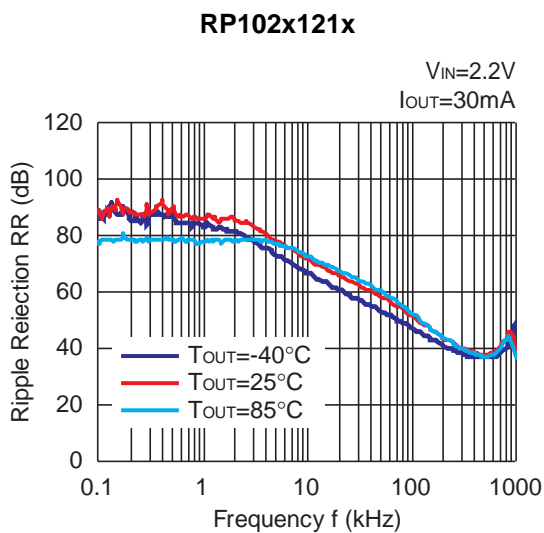
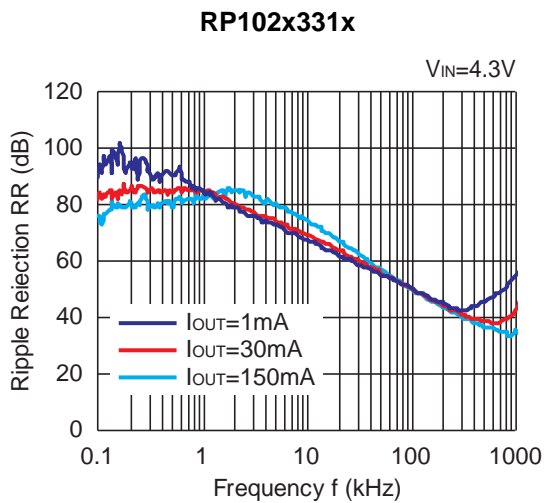
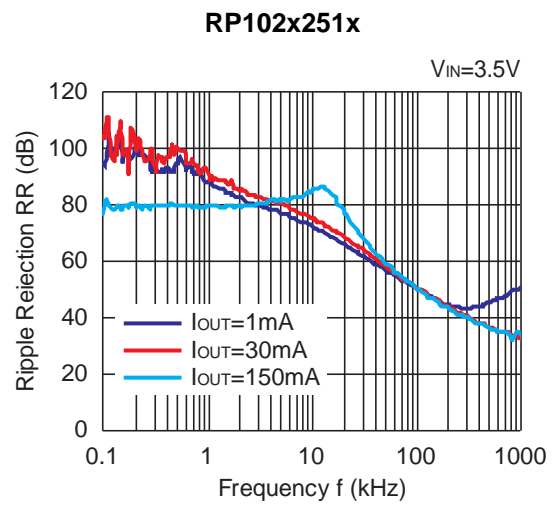
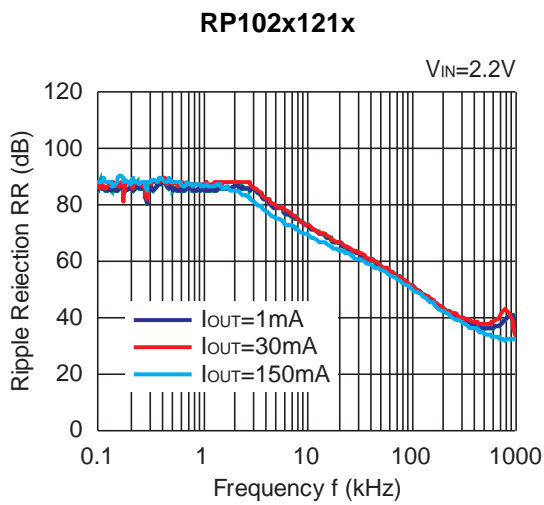

RP102x

NO.EA-141-160705

RP102x331x

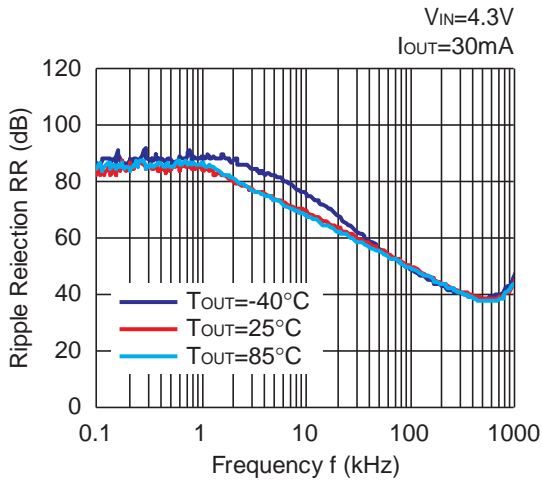

10) Input Transient Response ($C_{IN}=\text{none}$, $C_{OUT}=1.0\mu F$, $I_{OUT}=30mA$, $t_r=t_f=5\mu s$, $T_{opt}=25^{\circ}C$)

RP102x121x

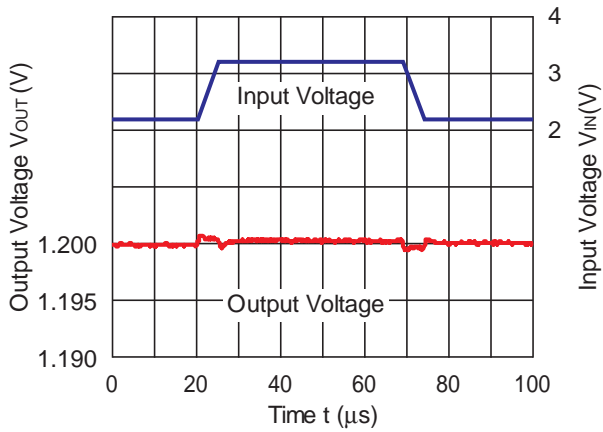

RP102x251x

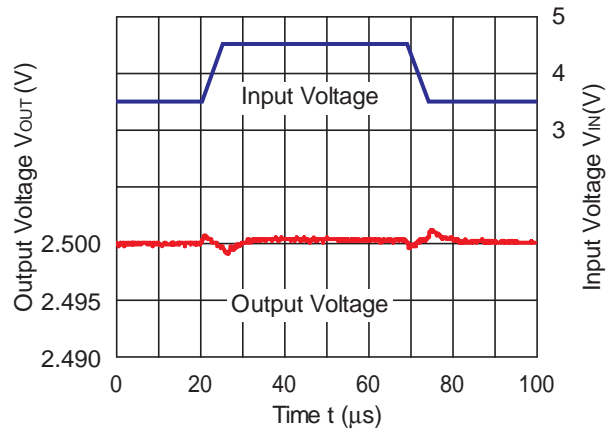

RP102x331x

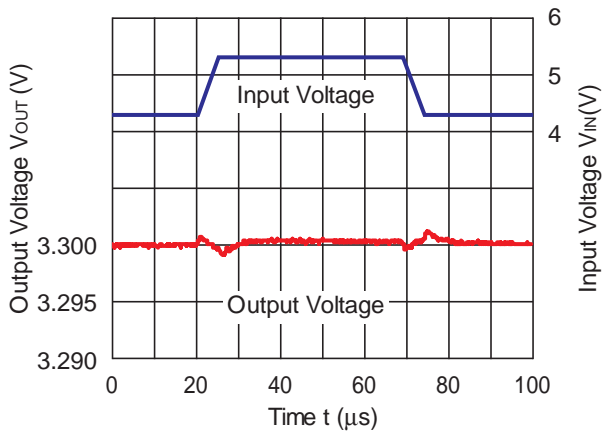

11) Load Transient Response ($C_{OUT}=1.0\mu F$, $T_{opt}=25^{\circ}C$)

RP102x121x

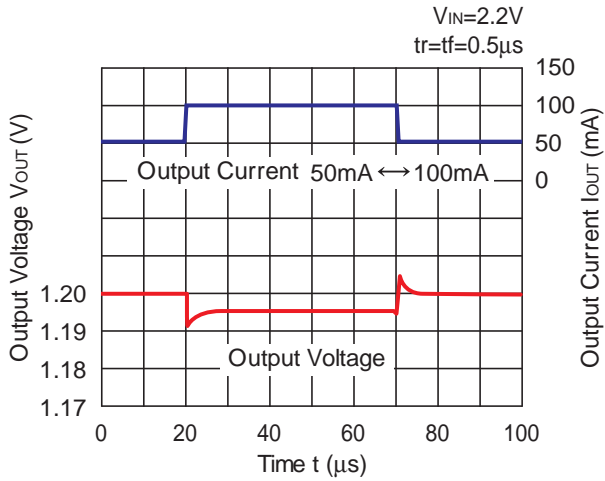

RP102x251x

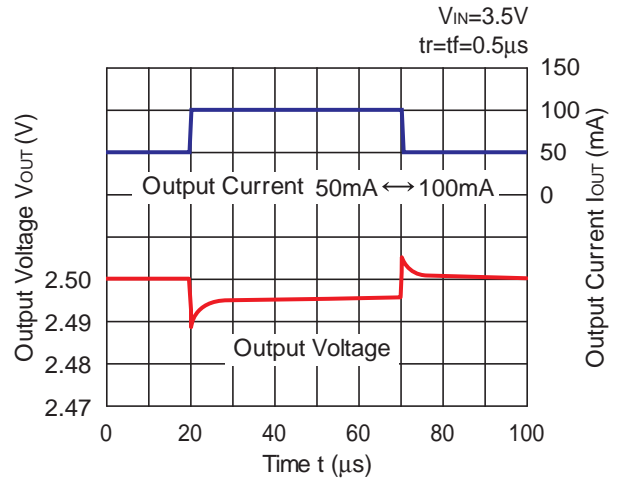

RP102x331x

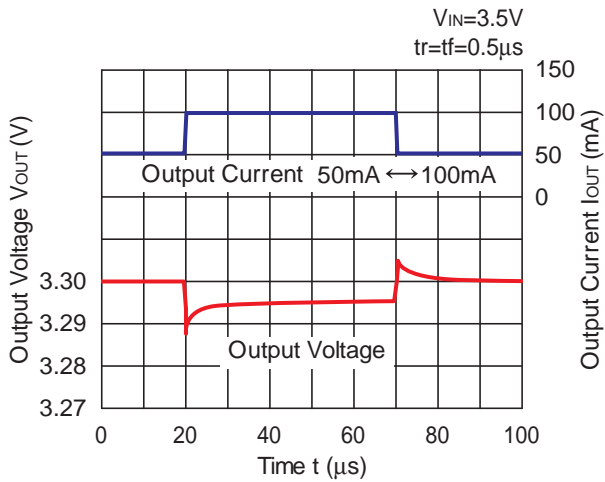

RP102x121x

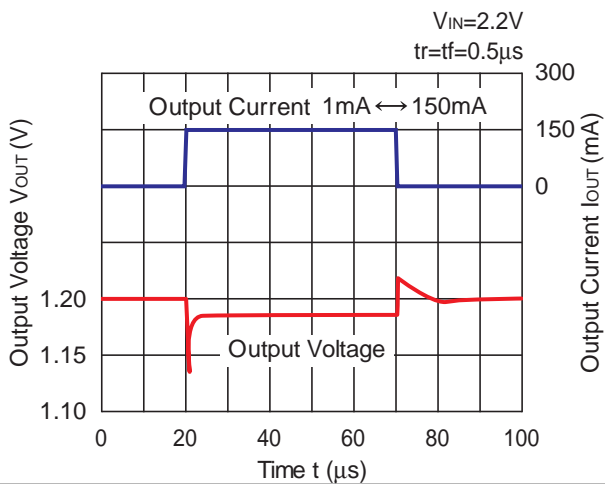

RP102x251x

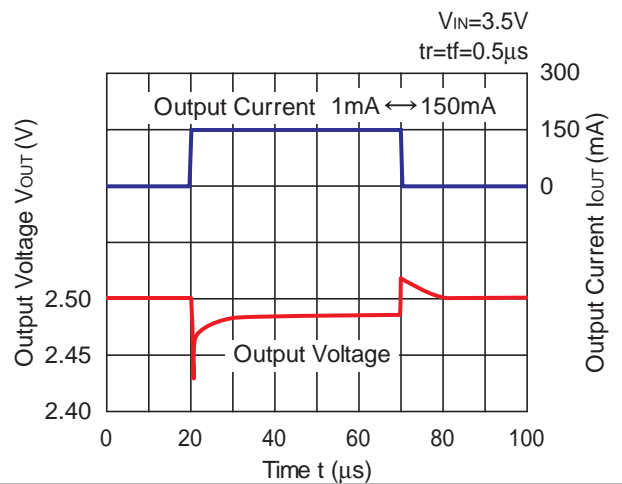

RP102x

NO.EA-141-160705

RP102x331x

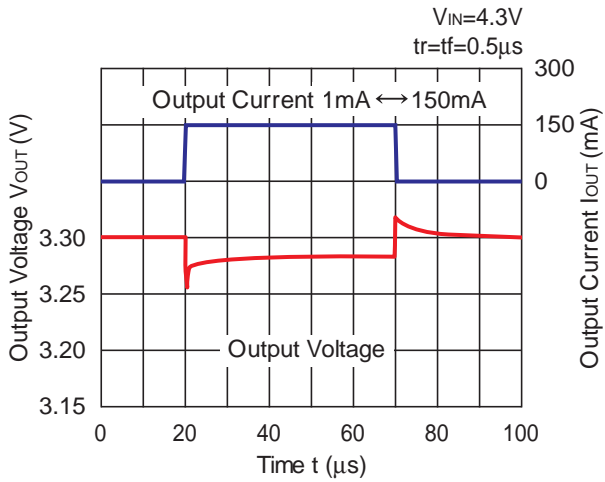

12) Turn On Speed with CE pin ($C_{IN}=1.0\mu F$, $C_{OUT}=1.0\mu F$, $T_{opt}=25^\circ C$)

RP102x121x

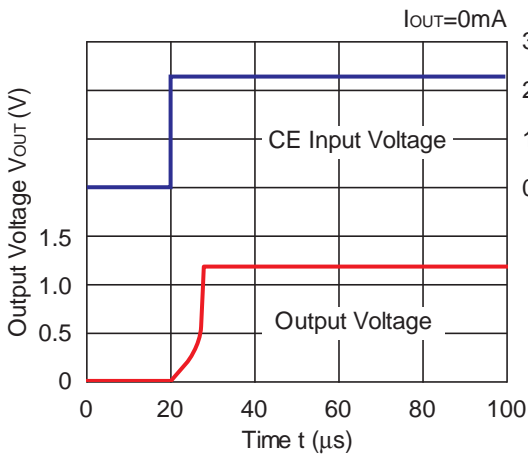

RP102x121x

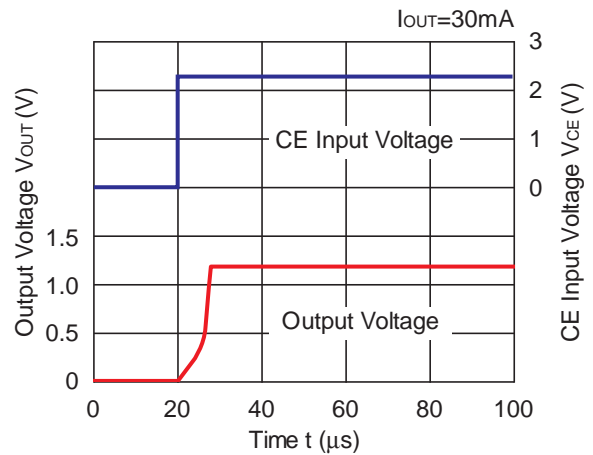

RP102x121x

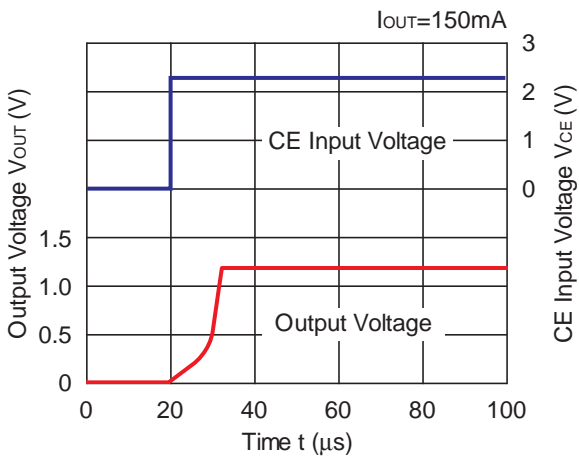

RP102x251x

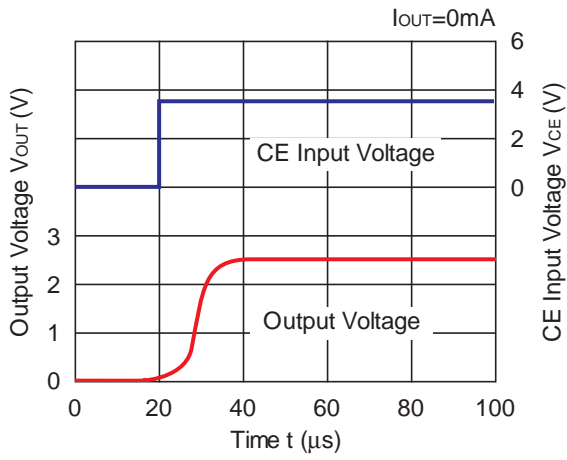

RP102x251x

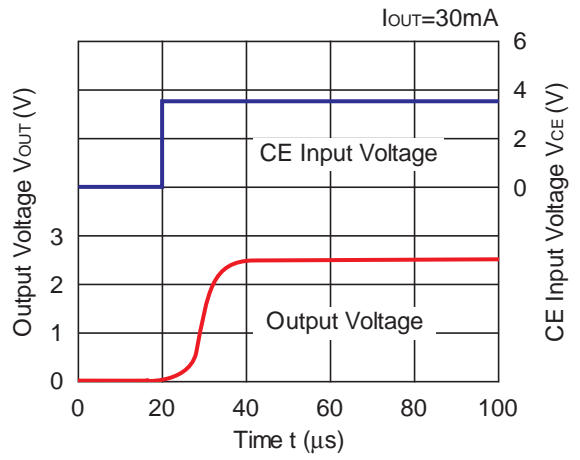

RP102x251x

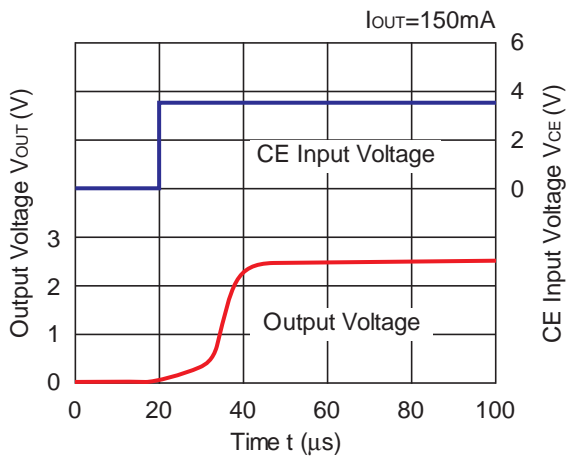

RP102x331x

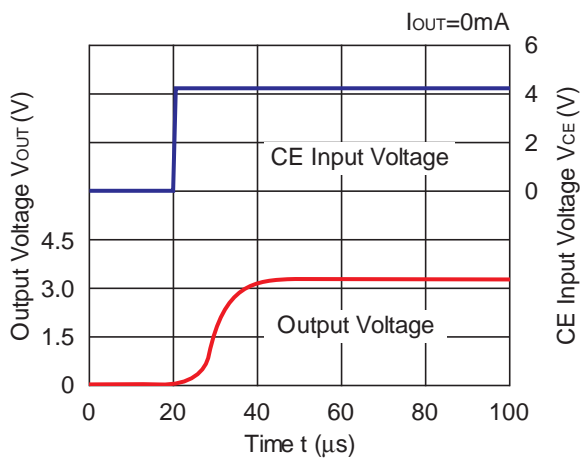

RP102x331x

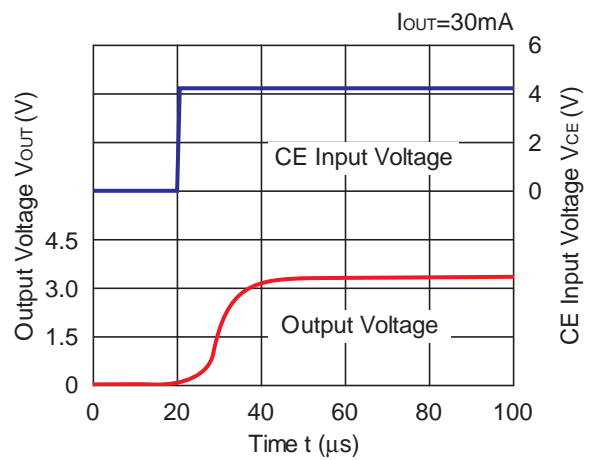

RP102x

NO.EA-141-160705

RP102x331x

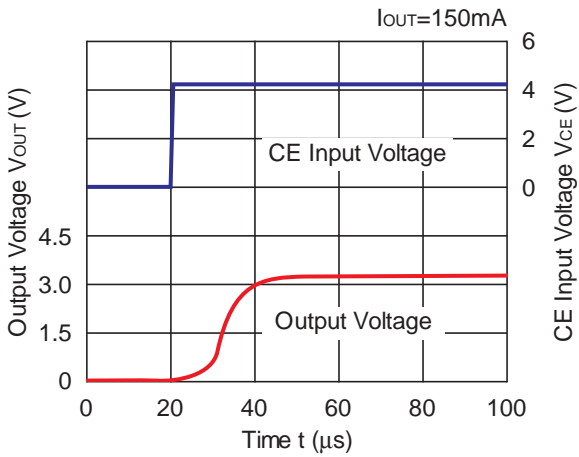

13) Turn OFF Speed with CE pin (D Version) ($C_{IN}=1.0\mu F$, $C_{OUT}=1.0\mu F$, $T_{opt}=25^{\circ}C$)

RP102x121D

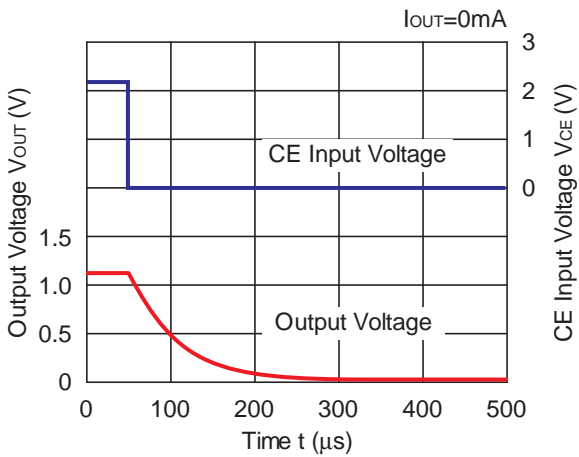

RP102x121D

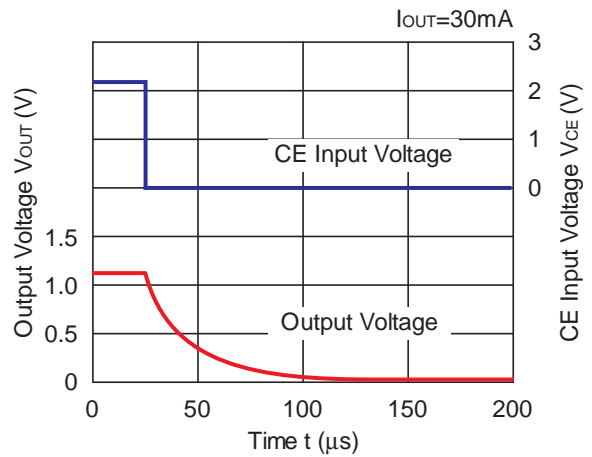

RP102x121D

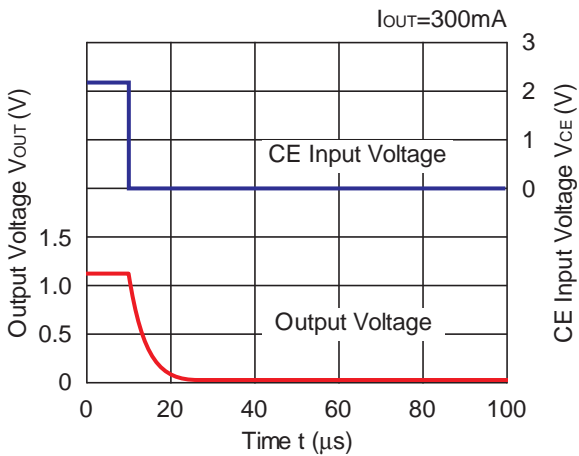

RP102x251x

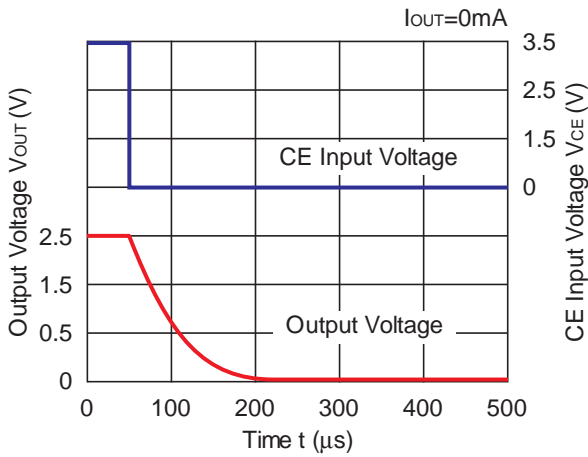

RP102x251x

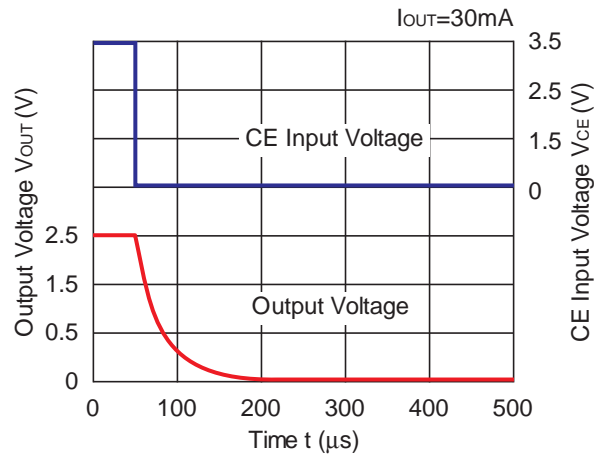

RP102x251x

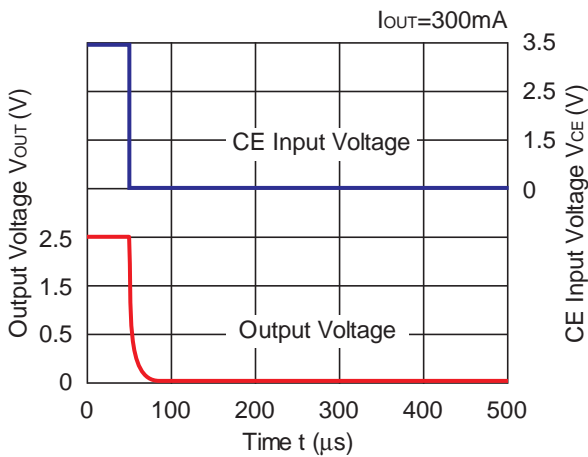

RP102x331x

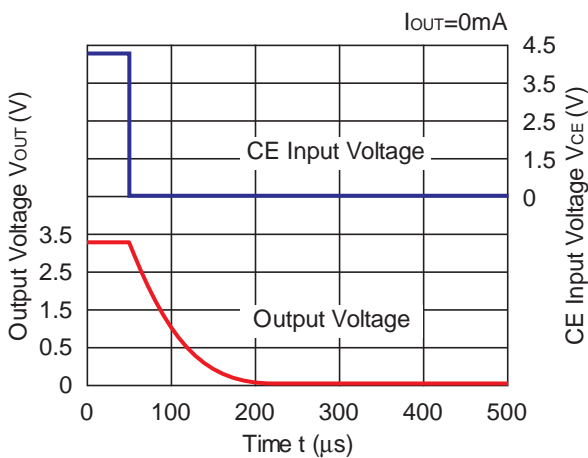

RP102x331x

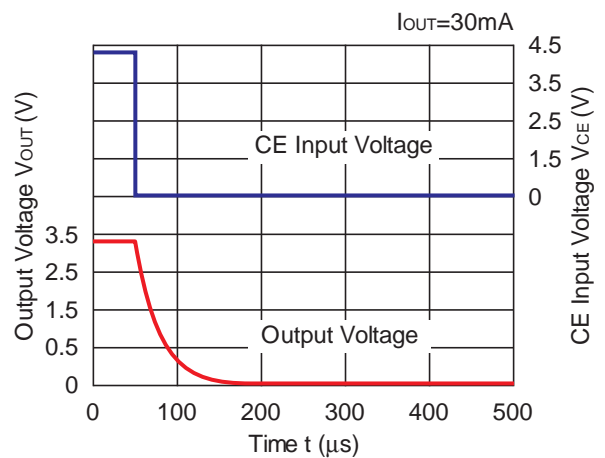

RP102xNO.EA-141-160705

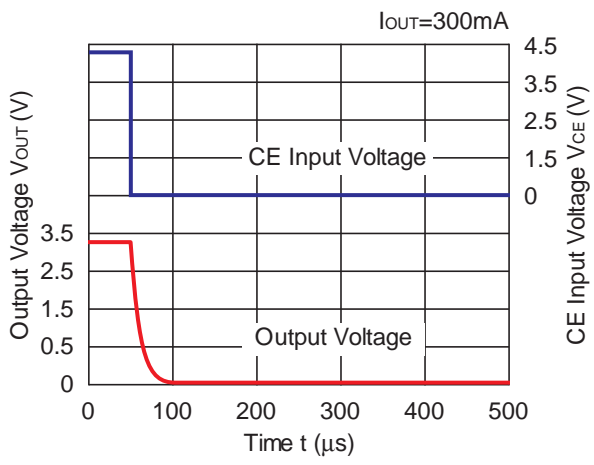
RP102x331x

ESR vs. Output Current

When using these ICs, consider the following points:

The relations between I_{OUT} (Output Current) and ESR of an output capacitor are shown below.

The conditions when the white noise level is under $40\mu V$ (Avg.) are marked as the hatched area in the graph.

Measurement conditions

Frequency Band: 10Hz to 2MHz

Temperature: $-40^{\circ}C$ to $85^{\circ}C$

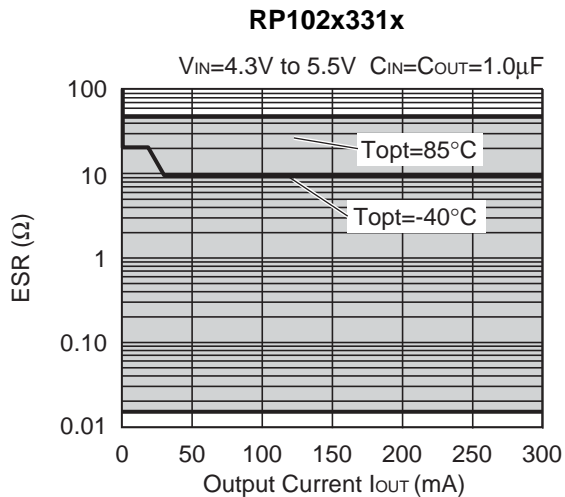
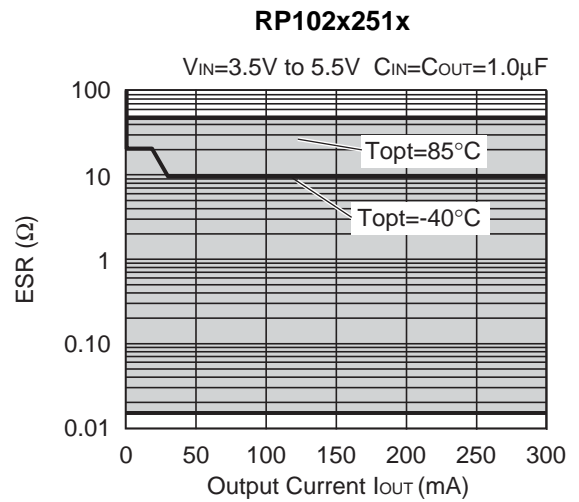
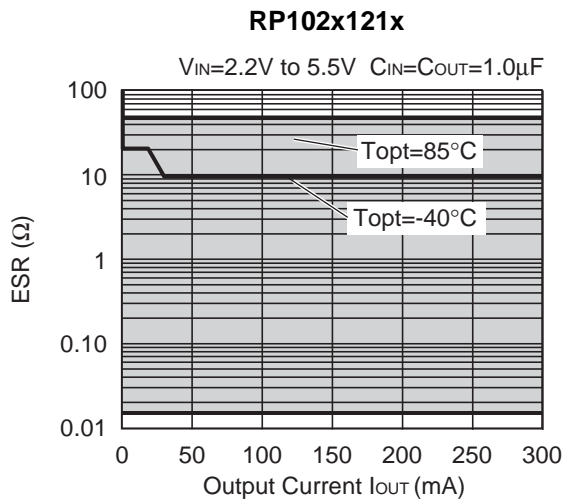

PACKAGE INFORMATION

Power Dissipation (WLCSP-4-P2)

This specification is at mounted on board. Power Dissipation (P_D) depends on conditions of mounting on board. This specification is based on the measurement at the condition below:

Measurement Conditions

	Standard Land Pattern
Environment	Mounting on Board (Wind velocity=0m/s)
Board Material	Glass cloth epoxy plastic (Double-sided)
Board Dimensions	40mm x 40mm x 1.6mm
Copper Ratio	Top side: Approx. 50%, Back side: Approx. 50%
Through-hole	$\phi 0.5\text{mm}$ x 4pcs

Measurement Result

($T_a=25^\circ\text{C}$)

	Standard Land Pattern
Power Dissipation	530mW ($T_{j\text{max}}=125^\circ\text{C}$) 662mW ($T_{j\text{max}}=150^\circ\text{C}$)
Thermal Resistance	$\theta_{ja}=(125-25^\circ\text{C})/0.53\text{W}=189^\circ\text{C/W}$

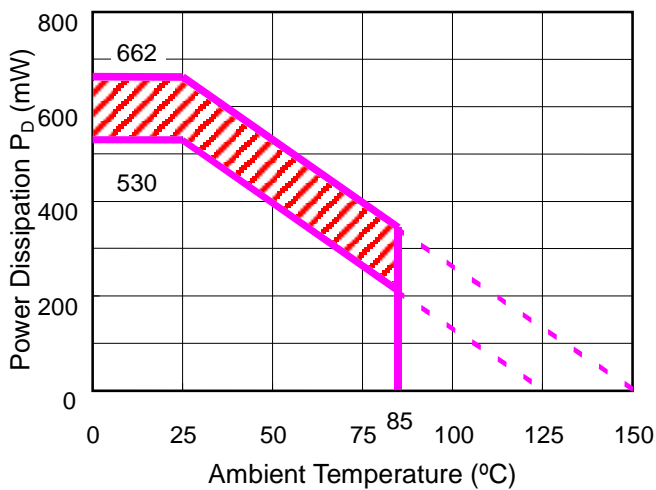

Power Dissipation

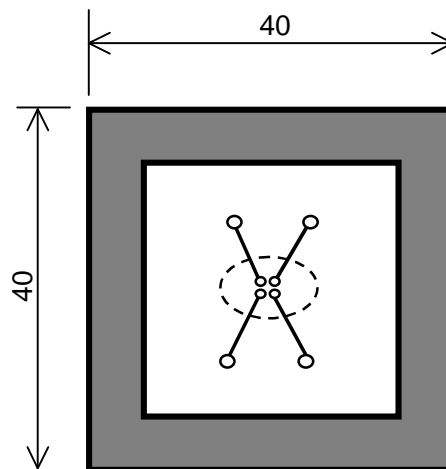

Measurement Board Pattern

IC Mount Area (Unit: mm)

The above graph shows the Power Dissipation of the package based on $T_{j\text{max}}=125^\circ\text{C}$ and $T_{j\text{max}}=150^\circ\text{C}$. Operating the IC in the shaded area in the graph might have an influence on its lifetime. Operating time must be within the time limit described in the table below, in case of operating in the shaded area.

Operating Time	Estimated years (Operating 4 hours/day)
13,000 hours	9years

Package Dimensions (WLCSP-4-P2)

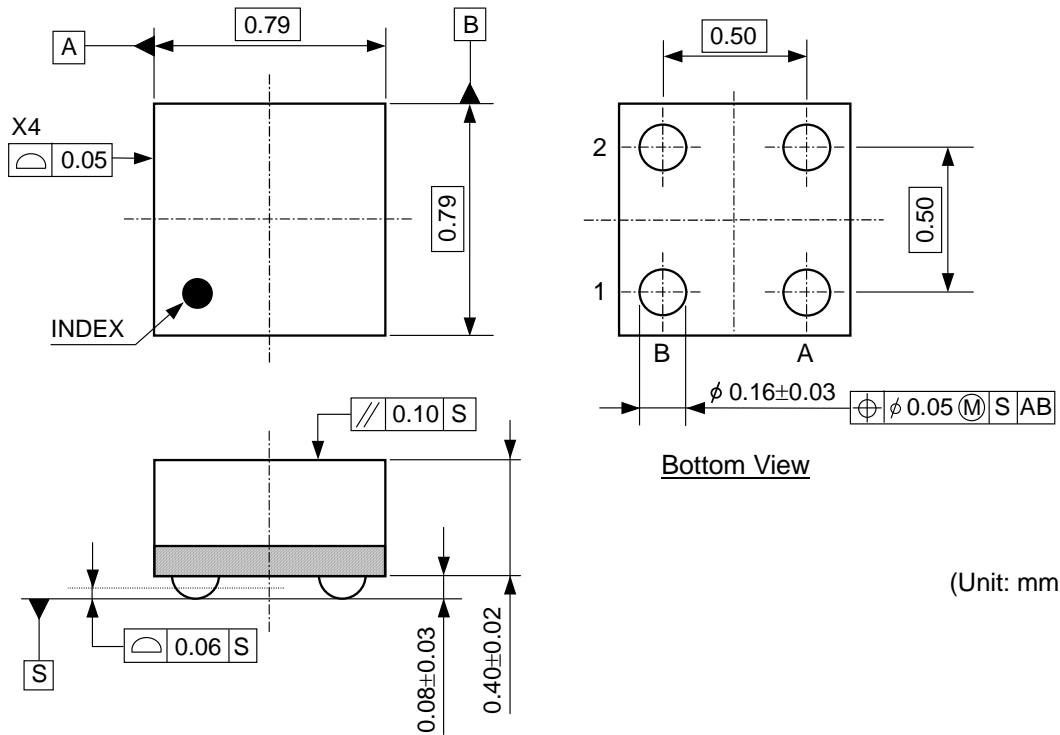

(Unit: mm)

Mark Specifications (WLCSP-4-P2)

①②: Lot Number ... Alphanumeric Serial Number

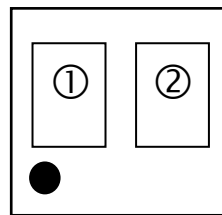

RP102x

NO.EA-141-160705

Power Dissipation (DFN(PL)1820-6)

This specification is at mounted on board. Power Dissipation (P_D) depends on conditions of mounting on board. This specification is based on the measurement at the condition below:

Measurement Conditions

	Standard Land Pattern
Environment	Mounting on Board (Wind velocity=0m/s)
Board Material	Glass cloth epoxy plastic (Double-sided)
Board Dimensions	40mm x 40mm x 1.6mm
Copper Ratio	Top side: Approx. 50%, Back side: Approx. 50%
Through-hole	$\phi 0.54\text{mm} \times 30\text{pcs}$

Measurement Result

($T_a=25^\circ\text{C}$)

	Standard Land Pattern
Power Dissipation	880mW($T_{j\text{max}}=125^\circ\text{C}$) 1100mW($T_{j\text{max}}=150^\circ\text{C}$)
Thermal Resistance	$\theta_{ja}=(125-25^\circ\text{C})/0.88\text{W}=114^\circ\text{C/W}$

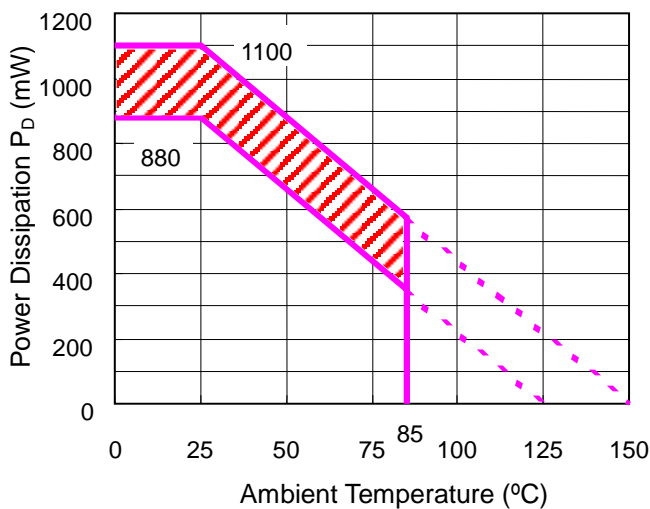

Power Dissipation

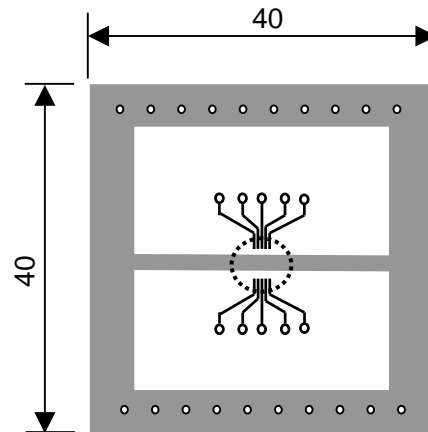

Measurement Board Pattern

○ IC Mount Area (Unit: mm)

The above graph shows the Power Dissipation of the package based on $T_{j\text{max}}=125^\circ\text{C}$ and $T_{j\text{max}}=150^\circ\text{C}$. Operating the IC in the shaded area in the graph might have an influence on its lifetime.

Operating time must be within the time limit described in the table below, in case of operating in the shaded area.

Operating Time	Estimated years (Operating 4 hours/day)
13,000 hours	9years

Package Dimensions (DFN(PL)1820-6)

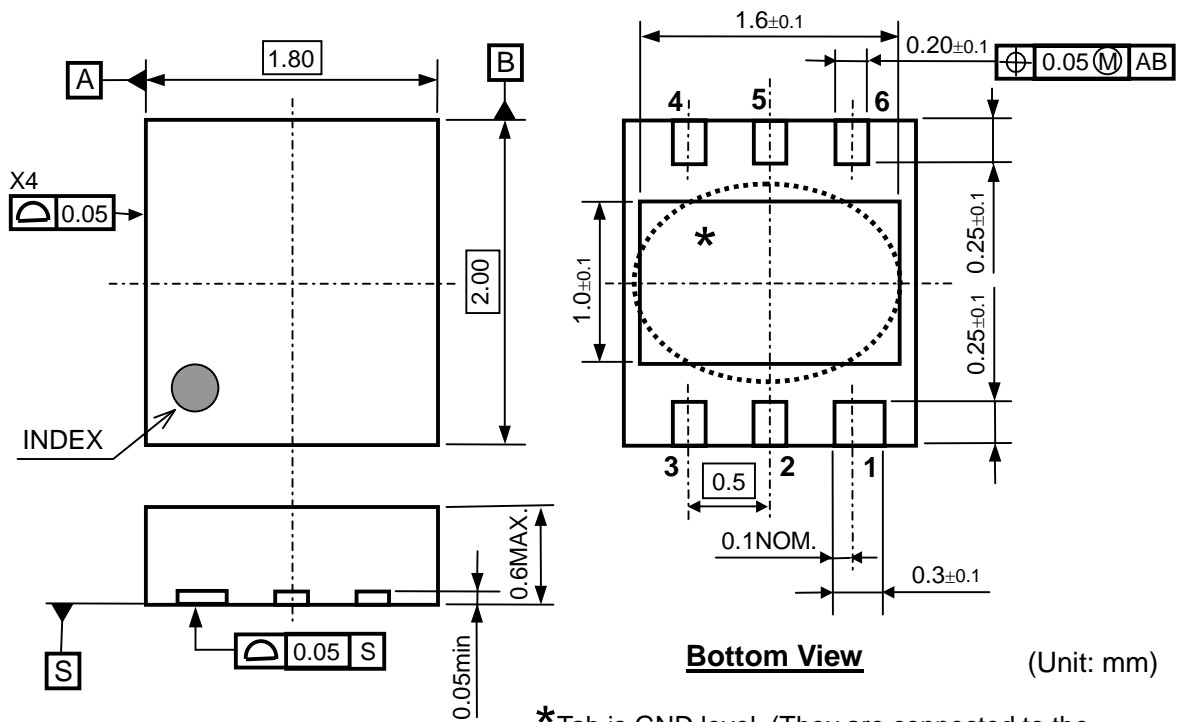

*Tab is GND level. (They are connected to the reverse side of this IC.)
 The tab is better to be connected to the GND, but leaving it open is also acceptable.

Mark Specifications (DFN(PL)1820-6)

- ①②③④: Product Code ... Refer to "RP102K Series Mark Specification Table".
- ⑤⑥: Lot Number ... Alphanumeric Serial Number

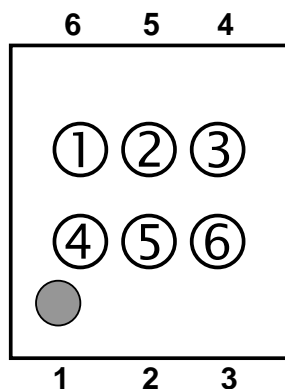

RP102K Series Mark Specification Table

PKG: DFN(PL)1820-6

RP102Kxx1B

Part Number	①②③④	Vset
RP102K121B	AC01	1.2V
RP102K131B	AC02	1.3V
RP102K151B	AC03	1.5V
RP102K181B	AC04	1.8V
RP102K251B	AC05	2.5V
RP102K261B	AC06	2.6V
RP102K281B	AC07	2.8V
RP102K281B5	AC08	2.85V
RP102K291B	AC09	2.9V
RP102K301B	AC10	3.0V
RP102K331B	AC11	3.3V
RP102K181B5	AC12	1.85V
RP102K271B	AC13	2.7V
RP102K121B5	AC14	1.25V
RP102K311B	AC15	3.1V
RP102K171B5	AC16	1.75V
RP102K211B	AC17	2.1V
RP102K141B	AC18	1.4V
RP102K321B	AC19	3.2V
RP102K171B	AC20	1.7V
RP102K201B	AC21	2.0V
RP102K291B5	AC22	2.95V
RP102K321B5	AC23	3.25V
RP102K161B	AC24	1.6V
RP102K191B	AC25	1.9V
RP102K221B	AC26	2.2V
RP102K231B	AC27	2.3V
RP102K241B	AC28	2.4V

RP102Kxx1D

Part Number	①②③④	Vset
RP102K121D	AD01	1.2V
RP102K131D	AD02	1.3V
RP102K151D	AD03	1.5V
RP102K181D	AD04	1.8V
RP102K251D	AD05	2.5V
RP102K261D	AD06	2.6V
RP102K281D	AD07	2.8V
RP102K281D5	AD08	2.85V
RP102K291D	AD09	2.9V
RP102K301D	AD10	3.0V
RP102K331D	AD11	3.3V
RP102K181D5	AD12	1.85V
RP102K271D	AD13	2.7V
RP102K121D5	AD14	1.25V
RP102K311D	AD15	3.1V
RP102K171D5	AD16	1.75V
RP102K211D	AD17	2.1V
RP102K141D	AD18	1.4V
RP102K321D	AD19	3.2V
RP102K171D	AD20	1.7V
RP102K201D	AD21	2.0V
RP102K291D5	AD22	2.95V
RP102K321D5	AD23	3.25V
RP102K161D	AD24	1.6V
RP102K191D	AD25	1.9V
RP102K221D	AD26	2.2V
RP102K231D	AD27	2.3V
RP102K241D	AD28	2.4V

Power Dissipation (SOT-23-5)

This specification is at mounted on board. Power Dissipation (P_D) depends on conditions of mounting on board. This specification is based on the measurement at the condition below:

(Power Dissipation (SOT-23-5) is substitution of SOT-23-6.)

Measurement Conditions

	Standard Test Land Pattern
Environment	Mounting on Board (Wind velocity=0m/s)
Board Material	Glass cloth epoxy plastic (Double sided)
Board Dimensions	40mm * 40mm * 1.6mm
Copper Ratio	Top side: Approx. 50%, Back side: Approx. 50%
Through-holes	ϕ 0.5mm * 44pcs

Measurement Result

($T_a=25^\circ\text{C}$)

	Standard Test Land Pattern	Free Air
Power Dissipation	420mW($T_{jmax}=125^\circ\text{C}$) 525mW($T_{jmax}=150^\circ\text{C}$)	250mW($T_{jmax}=125^\circ\text{C}$)
Thermal Resistance	$\theta_{ja} = (125-25^\circ\text{C})/0.42\text{W} = 263^\circ\text{C/W}$	400 $^\circ\text{C/W}$

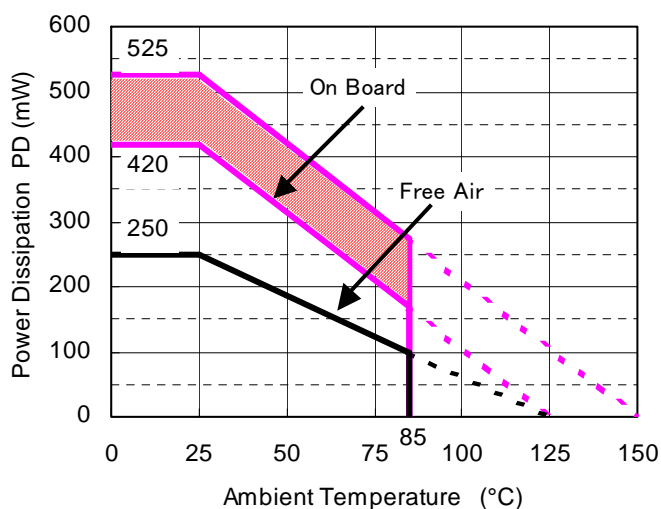

Power Dissipation

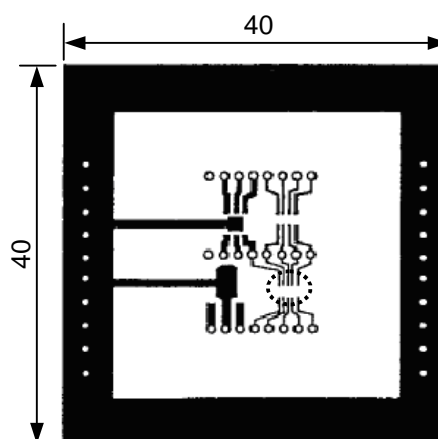

Measurement Board Pattern

○ IC Mount Area (Unit: mm)

The above graph shows the Power Dissipation of the package based on $T_{jmax}=125^\circ\text{C}$ and $T_{jmax}=150^\circ\text{C}$. Operating the IC in the shaded area in the graph might have an influence its lifetime. Operating time must be within the time limit described in the table below, in case of operating in the shaded area.

Operating Time	Estimated years (Operating four hours/day)
2,300 hours	1.5years

RP102x

NO.EA-141-160705

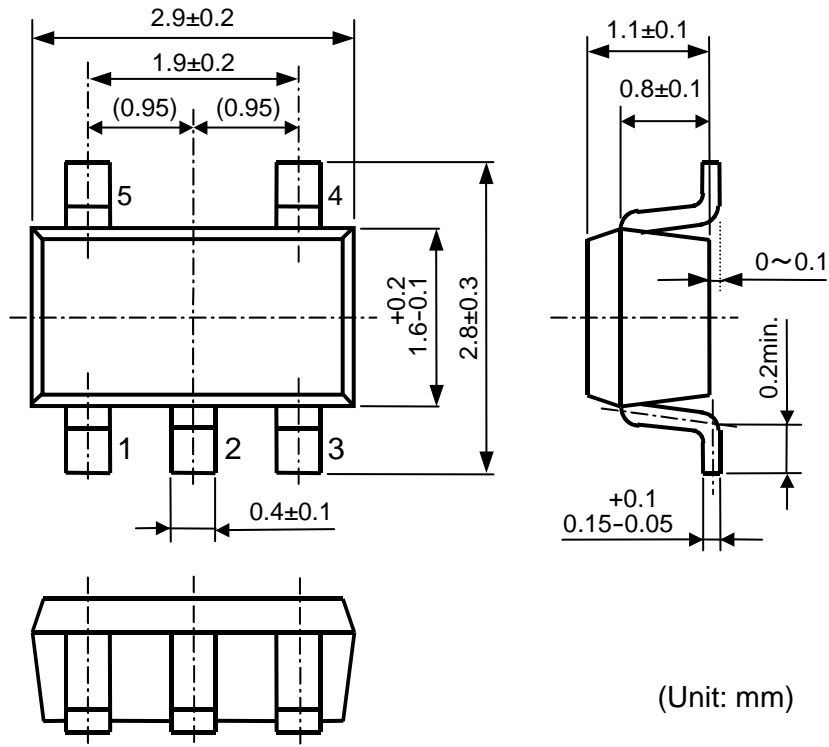
Package Dimensions (SOT-23-5)**Mark Specifications (SOT-23-5)**

- ①②③: Product Code ... Refer to "RP102N Series Mark Specification Table".
④⑤: Lot Number ... Alphanumeric Serial Number

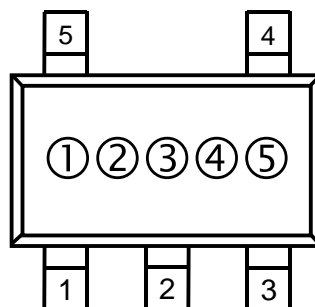

RP102N Series Mark Specification Table

PKG: SOT-23-5

RP102Nxx1B

Part Number	①②③	Vset
RP102N121B	60A	1.2V
RP102N131B	60B	1.3V
RP102N151B	60C	1.5V
RP102N181B	60D	1.8V
RP102N251B	60E	2.5V
RP102N261B	60F	2.6V
RP102N281B	60G	2.8V
RP102N281B5	60H	2.85V
RP102N291B	60J	2.9V
RP102N301B	60K	3.0V
RP102N331B	60L	3.3V
RP102N181B5	60M	1.85V
RP102N271B	60N	2.7V
RP102N121B5	60P	1.25V
RP102N311B	60Q	3.1V
RP102N171B5	60R	1.75V
RP102N211B	60S	2.1V
RP102N141B	60T	1.4V
RP102N321B	60U	3.2V
RP102N171B	60V	1.7V
RP102N201B	60W	2.0V
RP102N291B5	60X	2.95V
RP102N321B5	60Y	3.25V
RP102N161B5	60Z	1.6V
RP102N191B5	62A	1.9V
RP102N221B5	62B	2.2V
RP102N231B5	62C	2.3V
RP102N241B5	62D	2.4V

RP102Nxx1D

Part Number	①②③	Vset
RP102N121D	61A	1.2V
RP102N131D	61B	1.3V
RP102N151D	61C	1.5V
RP102N181D	61D	1.8V
RP102N251D	61E	2.5V
RP102N261D	61F	2.6V
RP102N281D	61G	2.8V
RP102N281D5	61H	2.85V
RP102N291D	61J	2.9V
RP102N301D	61K	3.0V
RP102N331D	61L	3.3V
RP102N181D5	61M	1.85V
RP102N271D	61N	2.7V
RP102N121D5	61P	1.25V
RP102N311D	61Q	3.1V
RP102N171D5	61R	1.75V
RP102N211D	61S	2.1V
RP102N141D	61T	1.4V
RP102N321D	61U	3.2V
RP102N171D	61V	1.7V
RP102N201D	61W	2.0V
RP102N291D5	61X	2.95V
RP102N321D5	61Y	3.25V
RP102N161D	61Z	1.6V
RP102N191D	63A	1.9V
RP102N221D	63B	2.2V
RP102N231D	63C	2.3V
RP102N241D	63D	2.4V



1. The products and the product specifications described in this document are subject to change or discontinuation of production without notice for reasons such as improvement. Therefore, before deciding to use the products, please refer to our sales representatives for the latest information thereon.
2. The materials in this document may not be copied or otherwise reproduced in whole or in part without prior written consent of our company.
3. Please be sure to take any necessary formalities under relevant laws or regulations before exporting or otherwise taking out of your country the products or the technical information described herein.
4. The technical information described in this document shows typical characteristics of and example application circuits for the products. The release of such information is not to be construed as a warranty of or a grant of license under our company's or any third party's intellectual property rights or any other rights.
5. The products listed in this document are intended and designed for use as general electronic components in standard applications (office equipment, telecommunication equipment, measuring instruments, consumer electronic products, amusement equipment etc.). Those customers intending to use a product in an application requiring extreme quality and reliability, for example, in a highly specific application where the failure or misoperation of the product could result in human injury or death (aircraft, spacevehicle, nuclear reactor control system, traffic control system, automotive and transportation equipment, combustion equipment, safety devices, life support system etc.) should first contact us.
6. We are making our continuous effort to improve the quality and reliability of our products, but semiconductor products are likely to fail with certain probability. In order to prevent any injury to persons or damages to property resulting from such failure, customers should be careful enough to incorporate safety measures in their design, such as redundancy feature, fire containment feature and fail-safe feature. We do not assume any liability or responsibility for any loss or damage arising from misuse or inappropriate use of the products.
7. Anti-radiation design is not implemented in the products described in this document.
8. The X-ray exposure can influence functions and characteristics of the products. Confirm the product functions and characteristics in the evaluation stage.
9. WLCSP products should be used in light shielded environments. The light exposure can influence functions and characteristics of the products under operation or storage.
10. There can be variation in the marking when different AOI (Automated Optical Inspection) equipment is used. In the case of recognizing the marking characteristic with AOI, please contact our sales or our distributor before attempting to use AOI.
11. Please contact our sales representatives should you have any questions or comments concerning the products or the technical information.



Nisshinbo Micro Devices Inc.

Official website

<https://www.nisshinbo-microdevices.co.jp/en/>

Purchase information

<https://www.nisshinbo-microdevices.co.jp/en/buy/>

