

400 mA Low Noise and Low Supply Current LDO Regulator

No.EA-403-230821

OVERVIEW

The RP122x is an LDO regulator that provides low output noise, high ripple rejection and fast response characteristics, achieved by low supply current. This device is suitable not only for noise-sensitive applications such as high-performance analog circuits, but also for various applications.

KEY BENEFITS

- Achieves Low Noise, High PSRR and Fast Response.
- Provides Saving Space by Adopting of 4-pin Small Package without Noise Bypass Capacitor.
- Provides Long-Duration of Operation for Battery-powered Equipment by Low Supply Current of 9.5 μ A (Typ.), despite the low-noise LDO.

KEY SPECIFICATIONS

- Input Voltage Range (Max.Rating): 1.9 V to 5.5 V (6.0 V)
- Output Voltage Range: 1.2 V to 4.8 V (0.1 V step)
- Output Voltage Accuracy: $\pm 0.8\%$ ($V_{SET} \geq 1.8$ V, $T_a = 25^\circ\text{C}$)
- Supply Current: Typ. 9.5 μ A
- Output Noise: Typ. 8 μ Vrms ($I_{OUT} = 250$ mA)
- Ripple Rejection: Typ. 90 dB ($f = 1$ kHz)
Typ. 85 dB ($f = 10$ kHz)
Typ. 65 dB ($f = 100$ kHz)
- Dropout Voltage: Typ. 0.145 V ($I_{OUT} = 400$ mA, $V_{SET} = 2.8$ V, RP122Z)
Typ. 0.170 V ($I_{OUT} = 400$ mA, $V_{SET} = 2.8$ V, RP122K/N)
- Protection Features: Thermal Shutdown Protection (Detection Temp. Typ. 165 $^\circ\text{C}$)
Inrush Current Limit at Typ. 250mA for appr. 700 μ s period after startup
- Ceramic Capacitor (C_{IN} , C_{OUT}): 1.0 μ F or more (No Need of Noise Bypass Capacitor)

TYPICAL APPLICATIONS

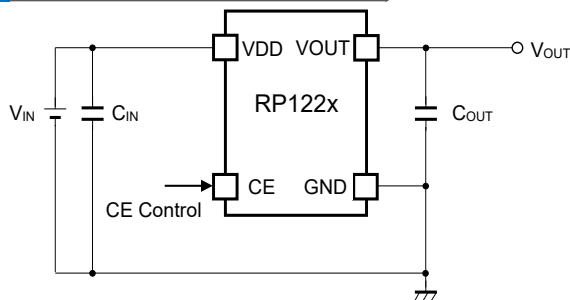

Without a bypass capacitor for noise

APPLICATIONS

- Mobile Phones and Tablets, Digital Cameras, Audio Devices, and Battery-powered Equipment
- RF Modules
- Clock Generator: VCO, PLL, etc.
- Noise-sensitive Devices: ADC, DAC

PACKAGE

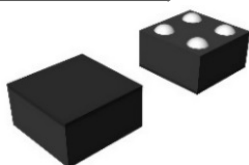

WLCSP-4-P8
0.64 x 0.64 x 0.36 (mm)

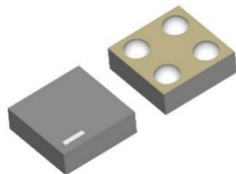

WLCSP-4-P12
0.64 x 0.64 x 0.26 (mm)

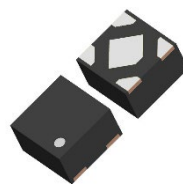

DFN(PL)1010-4B
1.00 x 1.00 x 0.6 (mm)

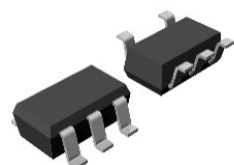

SOT-23-5
2.9 x 2.8 x 1.1 (mm)

SELECTION GUIDE

The set output voltage and the auto-discharge function⁽¹⁾ are user-selectable.

Product Name	Package	Quantity per Reel	Pb Free	Halogen Free
RP122Zxx1*-TR-F	WLCSP-4-P8	5,000 pcs	Yes	Yes
RP122Zxx3*-TR-F	WLCSP-4-P12	10,000 pcs	Yes	Yes
RP122Kxx1*-TR	DFN(PL)1010-4B	10,000 pcs	Yes	Yes
RP122Nxx1*-TR-FE	SOT-23-5	3,000 pcs	Yes	Yes

xx: Specify the set output voltage (V_{SET}) within the range of 1.2 V to 4.8 V in 0.1 V steps.

The voltage in 0.05 V step is shown as follows.

Ex. 1.85 V: RP122x18x*5

* : Specify whether with the auto-discharge or not.

B: without the auto-discharge function

D: with the auto-discharge function

BLOCK DIAGRAMS

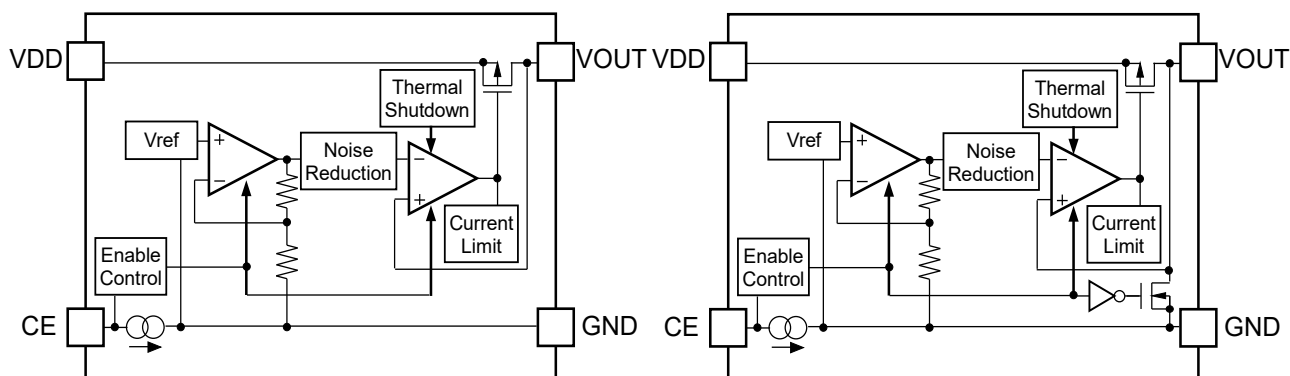

RP122xxxxB Block Diagram

RP122xxxxD Block Diagram

⁽¹⁾ Auto-discharge function quickly lowers the output voltage to 0 V, when the chip enable signal is switched from the active mode to the standby mode, by releasing the electrical charge accumulated in the external capacitor.

PIN DESCRIPTIONS

Top View

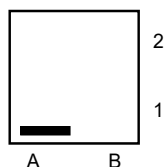

Bottom View

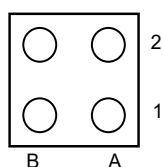

**RP122Z (WLCSP-4-P8 / WLCSP-4-P12)
Pin Configuration**

Top View

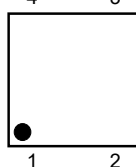

Bottom View

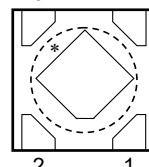

**RP122K (DFN (PL) 1010-4B)
Pin Configuration**

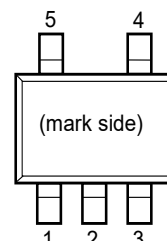

**RP122N (SOT-23-5)
Pin Configuration**

RP122Zxx1x(WLCSP-4-P8), RP122Zxx3x(WLCSP-4-P12) Pin Description

Pin No.	Symbol	Description
A1	VDD	Input Pin
A2	VOUT	Output Pin
B1	CE	Chip Enable Pin, Active-high
B2	GND	Ground Pin

RP122K Pin Description

Pin No.	Symbol	Description
1	VOUT	Output Pin
2	GND	Ground Pin
3	CE	Chip Enable Pin, Active-high
4	VDD	Input Pin

* The tab on the bottom of the package must be electrically connected to GND (substrate level) when mounted on the board.

RP122N Pin Description

Pin No.	Symbol	Description
1	VDD	Input Pin
2	GND	Ground Pin
3	CE	Chip Enable Pin, Active-high
4	NC	No Connection
5	VOUT	Output Pin

ABSOLUTE MAXIMUM RATINGS

Symbol	Item	Rating	Unit
V_{IN}	Input Voltage	-0.3 to 6.0	V
V_{CE}	Input Voltage (CE pin)	-0.3 to 6.0	V
V_{OUT}	Output Voltage	-0.3 to $V_{IN} + 0.3$	V
I_{OUT}	Output Current	600	mA
P_D	Power Dissipation	Refer to Appendix " <i>POWER DISSIPATION</i> "	
T_j	Junction Temperature Range	-40 to 125	°C
T_{stg}	Storage Temperature Range	-55 to 125	°C

ABSOLUTE MAXIMUM RATINGS

Electronic and mechanical stress momentarily exceeded absolute maximum ratings may cause permanent damage and may degrade the life time and safety for both device and system using the device in the field. The functional operation at or over these absolute maximum ratings are not assured.

RECOMMENDED OPERATING CONDITIONS

Symbol	Item	Rating	Unit
V_{IN}	Input Voltage	1.9 to 5.5	V
T_a	Operating Temperature Range	-40 to 85	°C

RECOMMENDED OPERATING CONDITIONS

All of electronic equipment should be designed that the mounted semiconductor devices operate within the recommended operating conditions. The semiconductor devices cannot operate normally over the recommended operating conditions, even if they are used over such ratings by momentary electronic noise or surge. And the semiconductor devices may receive serious damage when they continue to operate over the recommended operating conditions.

ELECTRICAL CHARACTERISTICS

$V_{IN} = V_{SET} + 1\text{ V}$ ($V_{IN} = 5.5\text{ V}$ when $V_{SET} \geq 4.5\text{ V}$), $I_{OUT} = 1\text{ mA}$, $C_{IN} = C_{OUT} = 1\mu\text{F}$, unless otherwise specified.

The specifications surrounded by are guaranteed by design engineering at $-40^{\circ}\text{C} \leq T_a \leq 85^{\circ}\text{C}$.

RP122xxxx Electrical Characteristics

($T_a = 25^{\circ}\text{C}$)

Symbol	Parameter		Conditions	Min.	Typ.	Max.	Unit		
V_{OUT}	Output Voltage		$T_a = 25^{\circ}\text{C}$	$V_{SET} \geq 1.8\text{V}$	x0.992		x1.008	V	
				$V_{SET} < 1.8\text{V}$	-14		+14	mV	
			$-40^{\circ}\text{C} \leq T_a \leq 85^{\circ}\text{C}$	$V_{SET} \geq 1.8\text{V}$	x0.987		x1.012		V
				$V_{SET} < 1.8\text{V}$	Refer to <i>PRODUCT-SPECIFIC ELECTRICAL CHARACTERISTICS</i>				
I_{OUT}	Output Current			400			mA		
$\frac{\Delta V_{OUT}}{\Delta I_{OUT}}$	Load Regulation	RP122Z	$1\text{ mA} \leq I_{OUT} \leq 400\text{ mA}$ $V_{IN} = V_{SET} + 0.5\text{ V}$, $V_{IN} \geq 1.9\text{ V}$		3	25	mV		
		RP122K/N	$1\text{ mA} \leq I_{OUT} \leq 400\text{ mA}$		13	40			
V_{DIF}	Dropout Voltage		$I_{OUT} = 400\text{ mA}$	Refer to <i>PRODUCT-SPECIFIC ELECTRICAL CHARACTERISTICS</i>					
I_{SS}	Supply Current		$I_{OUT} = 0\text{ mA}$		9.5	25	μA		
$I_{STANDBY}$	Standby Current		$V_{CE} = 0\text{ V}$		0.01	0.3	μA		
$\frac{\Delta V_{OUT}}{\Delta V_{IN}}$	Line Regulation		$1.2\text{V} \leq V_{SET} < 1.4\text{V}$	$1.9\text{V} \leq V_{IN} \leq 5.5\text{V}$		0.02	0.10	%V	
			$1.4\text{V} \leq V_{SET} < 4.3\text{V}$	$V_{SET} + 0.5\text{V} \leq V_{IN} \leq 5.5\text{V}$					
			$4.3\text{V} \leq V_{SET} \leq 4.8\text{V}$	$V_{SET} + 0.3\text{V} \leq V_{IN} \leq 5.5\text{V}$					
RR	Ripple Rejection		Ripple 0.2 Vp-p, $I_{OUT} = 20\text{ mA}$	$f = 1\text{ kHz}$		90	dB		
				$f = 10\text{ kHz}$		85			
				$f = 100\text{ kHz}$		65			
I_{SC}	Short Current Limit		$V_{OUT} = 0\text{ V}$		70		mA		
I_{PD}	CE Pull-down Current				0.25	0.50	μA		
V_{CEH}	CE Input Voltage, high			1.0			V		
V_{CEL}	CE Input Voltage, low					0.4	V		
en	Output Noise		BW =10Hz to 100kHz	$I_{OUT} = 1\text{ mA}$		12	μVrms		
				$I_{OUT} = 250\text{ mA}$		8			
T_{TSD}	Thermal Shutdown Temperature, detection		Junction Temperature			165	$^{\circ}\text{C}$		
T_{TSR}	Thermal Shutdown Temperature, released		Junction Temperature			110	$^{\circ}\text{C}$		
R_{LOW}	Auto-discharge NMOS On-resistance (RP122xxxxD only)		$V_{IN} = 5.0\text{ V}$, $CE = 0\text{ V}$,			50	Ω		

All test items listed under Electrical Characteristics are done under the pulse load condition ($T_j \approx T_a = 25^{\circ}\text{C}$) except Ripple Rejection and Output Noise.

The specifications surrounded by are guaranteed by design engineering at $-40^{\circ}\text{C} \leq T_a \leq 85^{\circ}\text{C}$

RP122xxxx Product-specific Electrical Characteristics

Product Name	V _{OUT} [V]						V _{DIF} [V]			
	T _a = 25°C			-40°C ≤ T _a ≤ 85°C			RP122Z		RP122K/N	
	Min.	Typ.	Max.	Min.	Typ.	Max.	Typ.	Max.	Typ.	Max.
RP122x12xx	1.186	1.200	1.214	1.180	1.200	1.218	(1)	(1)	(1)	(1)
RP122x12xx5	1.236	1.250	1.264	1.230	1.250	1.268	(1)	(1)	(1)	(1)
RP122x13xx	1.286	1.300	1.314	1.280	1.300	1.319	(1)	(1)	(1)	(1)
RP122x14xx	1.386	1.400	1.414	1.379	1.400	1.419	(1)	0.450 ⁽²⁾	(1)	0.500 ⁽²⁾
RP122x15xx	1.486	1.500	1.514	1.479	1.500	1.519	(1)	0.430	(1)	0.470
RP122x16xx	1.586	1.600	1.614	1.578	1.600	1.620	0.240 ⁽²⁾	0.385	0.270 ⁽²⁾	0.425
RP122x17xx	1.686	1.700	1.714	1.678	1.700	1.720	0.235	0.350	0.260	0.390
RP122x18xx	1.786	1.800	1.814	1.777	1.800	1.821	0.215	0.325	0.240	0.365
RP122x18xx5	1.836	1.850	1.864	1.826	1.850	1.872	0.215	0.325	0.240	0.365
RP122x19xx	1.885	1.900	1.915	1.876	1.900	1.922	0.200	0.305	0.225	0.345
RP122x20xx	1.984	2.000	2.016	1.974	2.000	2.024	0.190	0.290	0.215	0.330
RP122x21xx	2.084	2.100	2.116	2.073	2.100	2.125	0.180	0.270	0.205	0.310
RP122x22xx	2.183	2.200	2.217	2.172	2.200	2.226	0.170	0.260	0.195	0.300
RP122x23xx	2.282	2.300	2.318	2.271	2.300	2.327	0.170	0.260	0.195	0.300
RP122x24xx	2.381	2.400	2.419	2.369	2.400	2.428	0.170	0.260	0.195	0.300
RP122x25xx	2.480	2.500	2.520	2.468	2.500	2.530	0.155	0.240	0.180	0.280
RP122x26xx	2.580	2.600	2.620	2.567	2.600	2.631	0.155	0.240	0.180	0.280
RP122x27xx	2.679	2.700	2.721	2.665	2.700	2.732	0.155	0.240	0.180	0.280
RP122x28xx	2.778	2.800	2.822	2.764	2.800	2.833	0.145	0.225	0.170	0.265
RP122x28xx5	2.828	2.850	2.872	2.813	2.850	2.884	0.145	0.225	0.170	0.265
RP122x29xx	2.877	2.900	2.923	2.863	2.900	2.934	0.145	0.225	0.170	0.265
RP122x29xx5	2.927	2.950	2.973	2.912	2.950	2.985	0.145	0.225	0.170	0.265
RP122x30xx	2.976	3.000	3.024	2.961	3.000	3.036	0.145	0.225	0.170	0.265
RP122x30xx5	3.026	3.050	3.074	3.011	3.050	3.086	0.145	0.225	0.170	0.265
RP122x31xx	3.076	3.100	3.124	3.060	3.100	3.137	0.145	0.225	0.170	0.265
RP122x31xx5	3.125	3.150	3.175	3.110	3.150	3.187	0.145	0.225	0.170	0.265
RP122x32xx	3.175	3.200	3.225	3.159	3.200	3.238	0.145	0.225	0.170	0.265
RP122x33xx	3.274	3.300	3.326	3.258	3.300	3.339	0.130	0.205	0.155	0.245
RP122x34xx	3.373	3.400	3.427	3.356	3.400	3.440	0.130	0.205	0.155	0.245
RP122x35xx	3.472	3.500	3.528	3.455	3.500	3.542	0.130	0.205	0.155	0.245
RP122x36xx	3.572	3.600	3.628	3.554	3.600	3.643	0.120	0.195	0.145	0.235

⁽¹⁾ Input voltage should be equal or more than the minimum operating voltage of 1.9 V.

⁽²⁾ When "Output voltage + Dropout Voltage" < 1.9 V, input voltage must be equal or more than the minimum operating voltage of 1.9 V.

The specifications surrounded by are guaranteed by design engineering at $-40^{\circ}\text{C} \leq T_a \leq 85^{\circ}\text{C}$

RP122xxxxx Product-specific Electrical Characteristics

Product Name	V_{OUT} [V]						V_{DIF} [V]			
	$T_a = 25^{\circ}\text{C}$			$-40^{\circ}\text{C} \leq T_a \leq 85^{\circ}\text{C}$			RP122Z		RP122K/N	
	Min.	Typ.	Max.	Min.	Typ.	Max.	Typ.	Max.	Typ.	Max.
RP122x37xx	3.671	3.700	3.729	3.652	3.700	3.744	0.120	0.195	0.145	0.235
RP122x38xx	3.770	3.800	3.830	3.751	3.800	3.845	0.120	0.195	0.145	0.235
RP122x39xx	3.869	3.900	3.931	3.850	3.900	3.946	0.120	0.195	0.145	0.235
RP122x40xx	3.968	4.000	4.032	3.948	4.000	4.048	0.115	0.185	0.140	0.225
RP122x41xx	4.068	4.100	4.132	4.047	4.100	4.149	0.115	0.185	0.140	0.225
RP122x42xx	4.167	4.200	4.233	4.146	4.200	4.250	0.115	0.185	0.140	0.225
RP122x42xx5	4.216	4.250	4.284	4.195	4.250	4.301	0.115	0.185	0.140	0.225
RP122x43xx	4.266	4.300	4.334	4.245	4.300	4.351	0.115	0.185	0.140	0.225
RP122x44xx	4.365	4.400	4.435	4.343	4.400	4.452	0.115	0.185	0.140	0.225
RP122x45xx	4.464	4.500	4.536	4.442	4.500	4.554	0.115	0.185	0.140	0.225
RP122x45xx5	4.514	4.550	4.586	4.491	4.550	4.604	0.115	0.185	0.140	0.225
RP122x46xx	4.564	4.600	4.636	4.541	4.600	4.655	0.115	0.185	0.140	0.225
RP122x47xx	4.663	4.700	4.737	4.639	4.700	4.756	0.115	0.185	0.140	0.225
RP122x48xx	4.762	4.800	4.838	4.738	4.800	4.857	0.115	0.185	0.140	0.225

THEORY OF OPERATION

Inrush Current Limit

The inrush current limit value at start-up increases in proportion to the capacitance of C_{OUT} . If not flow the load current (I_{LOAD}) except the charge current to C_{OUT} , the inrush current reaches 250mA when the effective capacitance of C_{OUT} becomes appr.6.0 μ F or more, and the inrush current limit protection runs. During appr.700 μ s after the CE pin becomes "H", the inrush current, which occurs at charging the capacitor of C_{OUT} , is limited at appr.250 mA. The power-on time (t_{ON}) can be calculated from the following equation. If the capacitance value of C_{OUT} is too much, the time-out occurs and the inrush current increases.

$$t_{ON} = t_D + C_{OUT} \cdot V_{SET} / I_{LIM_START}$$

t_D : Delay Time at Start-up Typ.50 μ s

V_{SET} : Set Output Voltage

I_{LIM_START} : Limit Current at Start-up Typ.250 mA

If flow the load current (I_{LOAD}) except the charge current to C_{OUT} during start-up, the start-up time becomes longer. The load current over I_{LIM_START} cannot be applied.

Minimum Operating Voltage

The RP122x does not include an UVLO circuit. To make the internal circuit operate normally and to ensure good output regulation, V_{IN} has to be: $V_{IN} \geq V_{SET} + V_{DIF}$ (Min.1.9 V). To bring out the best characteristics of the output noise voltage, the ripple rejection and the load transient response, V_{IN} has to be $V_{IN} = V_{SET} + 1.0$ V.

Thermal Shutdown Protection

Thermal shutdown deactivates the circuit when the junction temperature exceeds the thermal shutdown threshold (T_{TSD}) of Typ. 165 $^{\circ}$ C, and reactivates it when the junction temperature falls below the thermal shutdown release threshold (T_{TSR}) of Typ. 110 $^{\circ}$ C. During the reactivation, the inrush current limit is in operation. Note that deactivation and activation cycle can be repeated due to load, heat dissipation and ambient temperature conditions. Thermal shutdown cannot be used for the purpose of heat sink, so the repetitive cycles of deactivation and activation may affect the reliability of the device.

APPLICATION INFORMATION

Typical Application Circuit

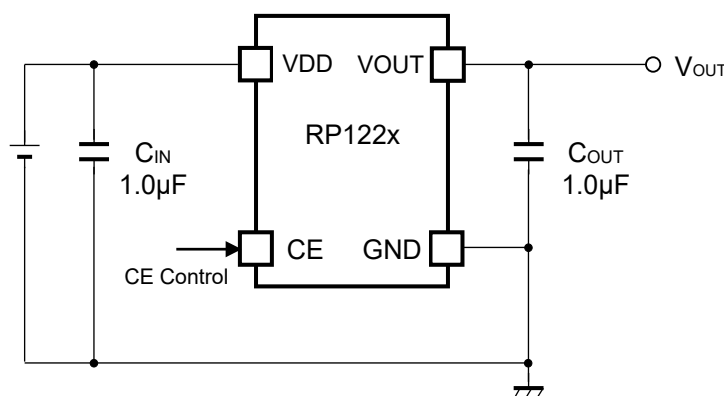

RP122x Typical Application Circuit

Technical Notes Related to External Components

- Ensure the VDD and GND lines are sufficiently robust. If their impedances are too high, noise pickup or unstable operation may result. Connect a 1.0 μF or more input capacitor (C_{IN}) between the VDD and GND pins with shortest-distance wiring. It is recommended to use a ceramic capacitor of 6.3 V and more such as the X7R and the X5R having small temperature dependence to ESR, ESL, and capacitance.
- Phase compensation is provided to secure stable operation even when the load current is varied. For this purpose, use a ceramic capacitor of 1.0 μF or more with ESR (Equivalent Series Resistance) of up to 300 m Ω to connect the output capacitor (C_{OUT}) between the VOUT and GND pins with shortest-distance wiring. Besides, set for the output capacitor to ensure the following effective capacitance in consideration of the dependence of temperature, DC bias, and package size.

Set Output Voltage (V_{SET})	Effective Capacitance
$1.2 \text{ V} \leq V_{\text{SET}} < 2.0 \text{ V}$	0.75 μF and more
$2.0 \text{ V} \leq V_{\text{SET}} < 3.4 \text{ V}$	0.70 μF and more
$3.4 \text{ V} \leq V_{\text{SET}} \leq 4.8 \text{ V}$	0.60 μF and more

In case of using a tantalum type capacitor with a large ESR, the output might become unstable. Evaluate your circuit including consideration of frequency characteristics with a parallel connection the above ceramic and the tantalum type capacitors.

TYPICAL CHARACTERISTICS

Typical Characteristics are intended to be used as reference data, they are not guaranteed.

1) Output Voltage vs. Temperature ($C_{IN} = \text{Ceramic } 1.0 \mu\text{F}$, $C_{OUT} = \text{Ceramic } 1.0 \mu\text{F}$)

RP122x12xx, $V_{IN} = 2.2 \text{ V}$, $I_{OUT} = 1 \text{ mA}$

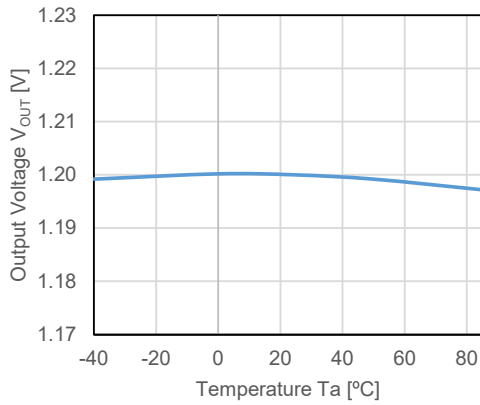

RP122x28xx, $V_{IN} = 3.8 \text{ V}$, $I_{OUT} = 1 \text{ mA}$

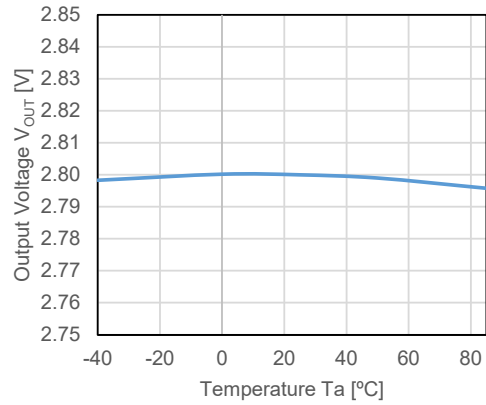

RP122x48xx, $V_{IN} = 5.5 \text{ V}$, $I_{OUT} = 1 \text{ mA}$

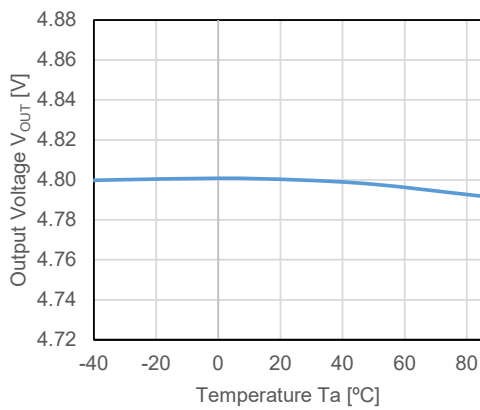

2) Supply Current vs. Temperature ($C_{IN} = \text{Ceramic } 1.0 \mu\text{F}$, $C_{OUT} = \text{Ceramic } 1.0 \mu\text{F}$)

RP122x12xx, $V_{IN} = 2.2 \text{ V}$

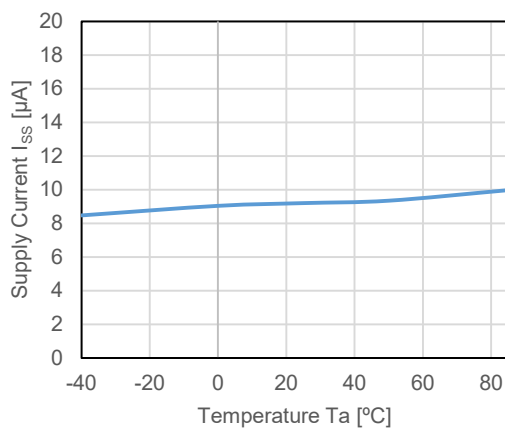

RP122x28xx, $V_{IN} = 3.8 \text{ V}$

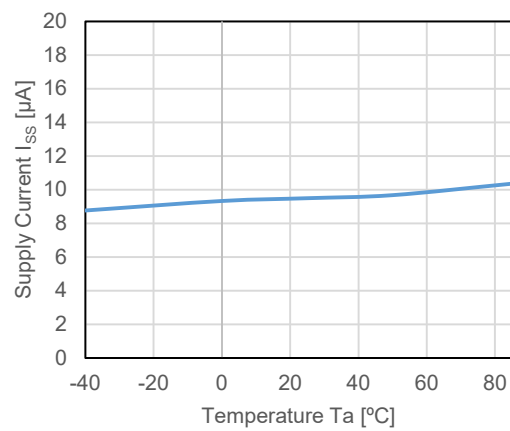

RP122x48xx, $V_{IN} = 5.5\text{ V}$

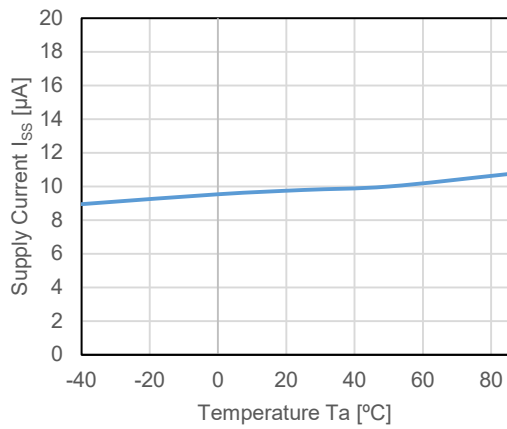

3) Dropout Voltage vs. Output Current ($C_{IN} = \text{Ceramic } 1.0\ \mu\text{F}$, $C_{OUT} = \text{Ceramic } 1.0\ \mu\text{F}$)

RP122Z18xx

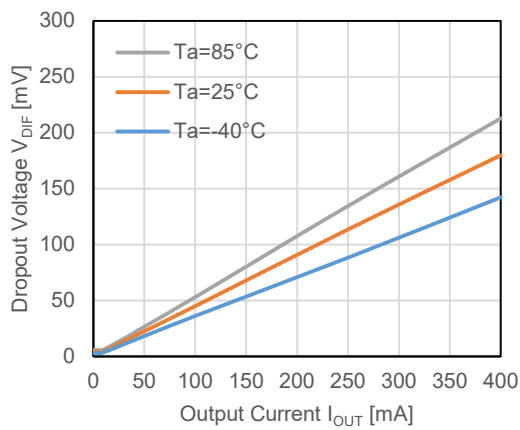

RP122K/N181x

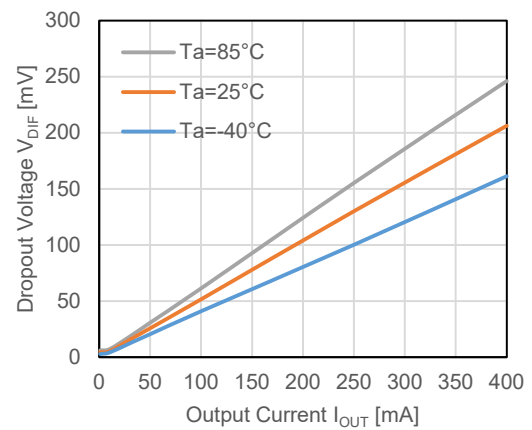

RP122Z28xx

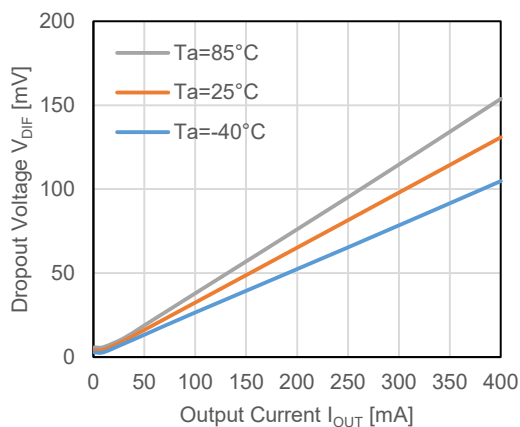

RP122K/N281x

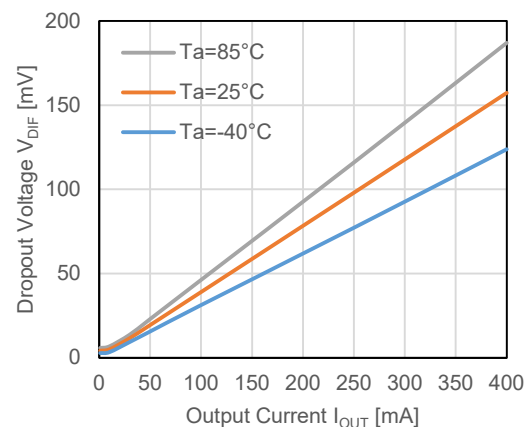

RP122Z48xx

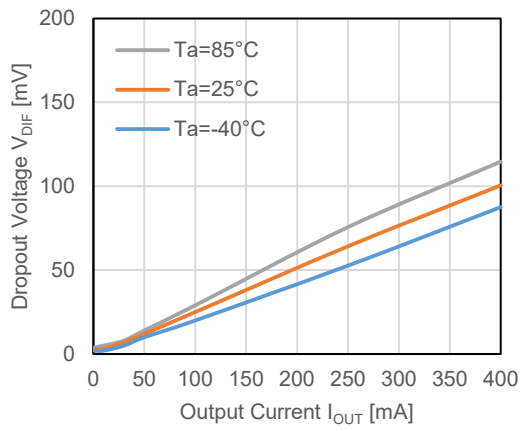

RP122K/N481x

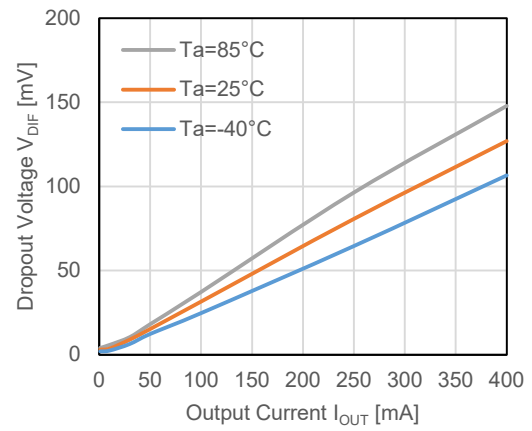

4) Dropout Voltage vs. Temperature ($C_{IN} = \text{Ceramic } 1.0 \mu\text{F}$, $C_{OUT} = \text{Ceramic } 1.0 \mu\text{F}$)

RP122Z18xx

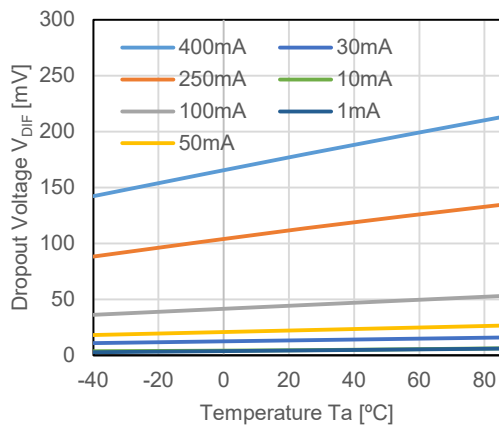

RP122K/N181x

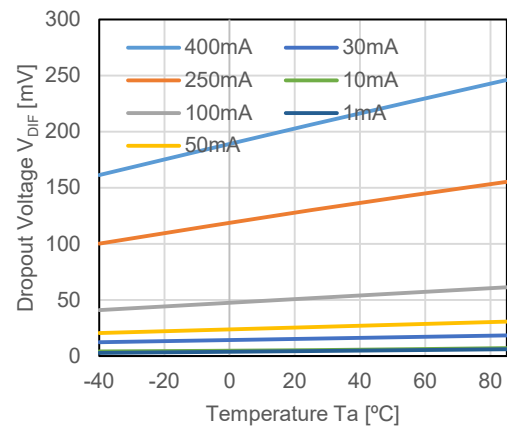

RP122Z28xx

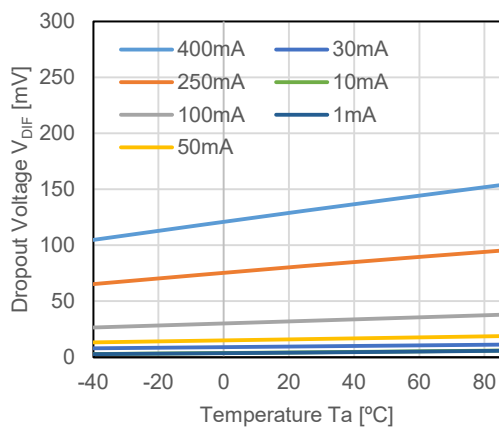

RP122K/N281x

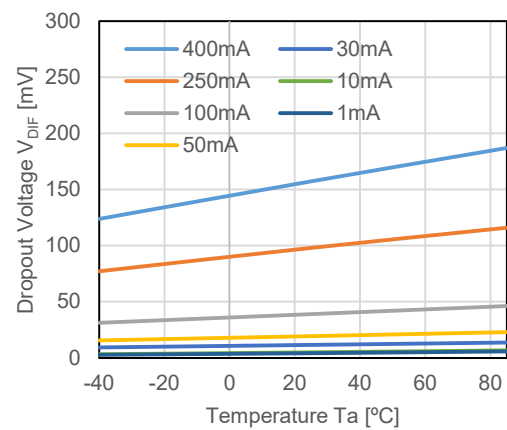

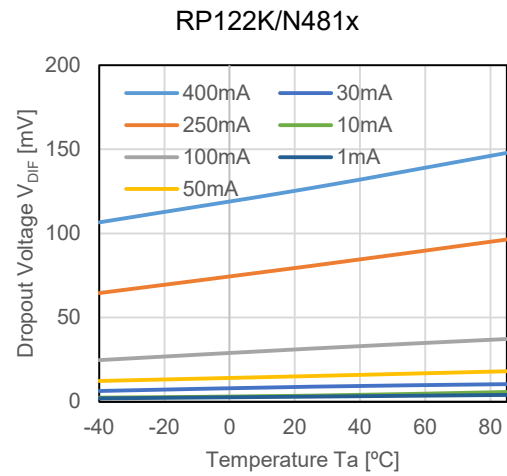
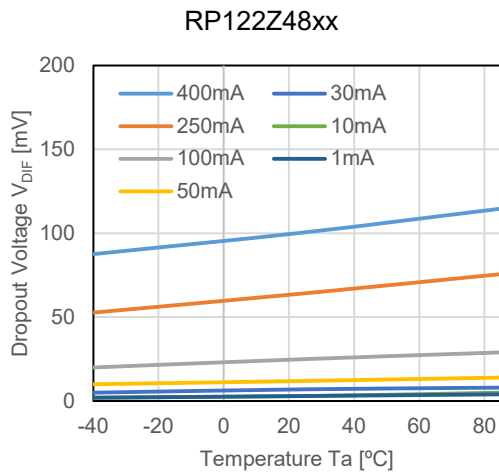

5) Dropout Voltage vs. Set Output Voltage ($C_{IN} = \text{Ceramic } 1.0 \mu\text{F}$, $C_{OUT} = \text{Ceramic } 1.0 \mu\text{F}$, $T_a = 25^\circ\text{C}$)

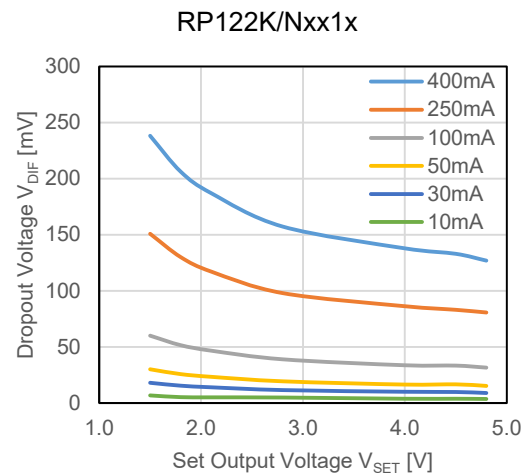
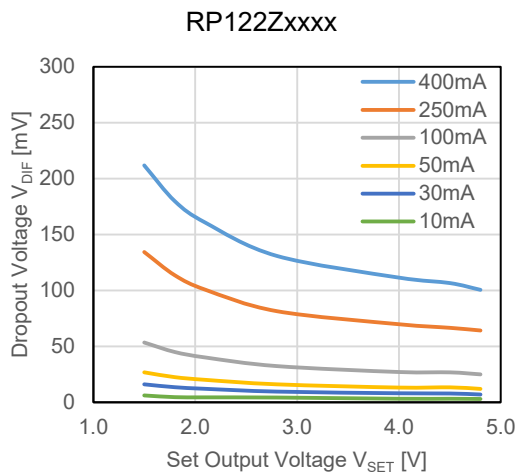

6) Output Voltage vs. Output Current ($C_{IN} = \text{Ceramic } 1.0 \mu\text{F}$, $C_{OUT} = \text{Ceramic } 1.0 \mu\text{F}$, $T_a = 25^\circ\text{C}$)

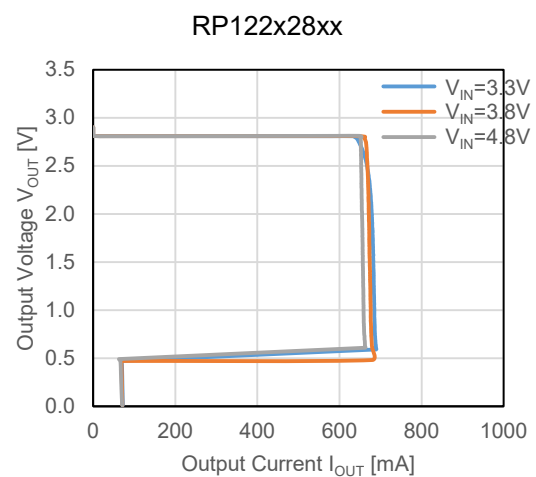
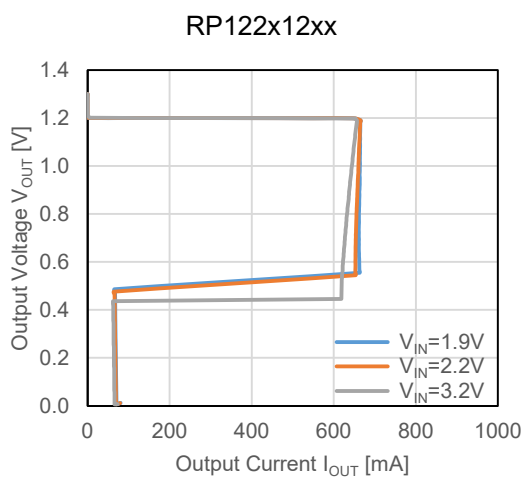

RP122x48xx

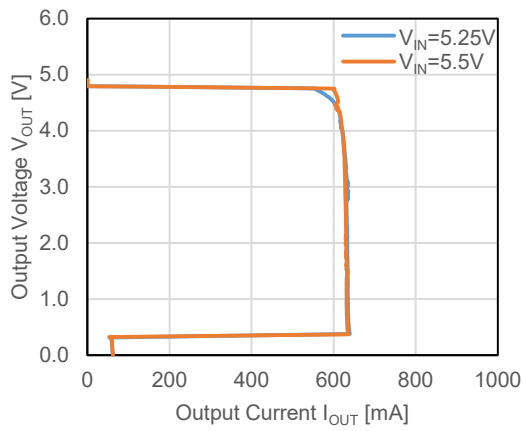

7) Output Voltage vs. Input Voltage (C_{IN} = Ceramic 1.0 μ F, C_{OUT} = Ceramic 1.0 μ F, T_a = 25°C)

RP122x12xx

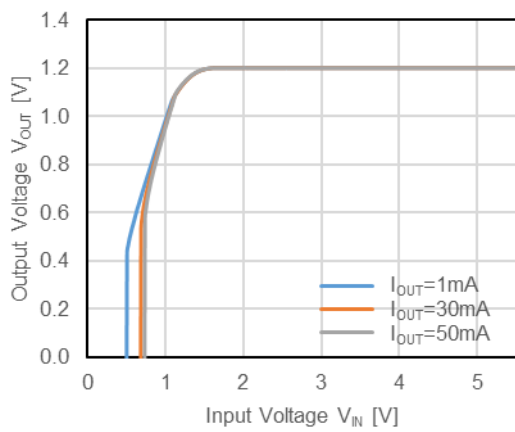

RP122x28xx

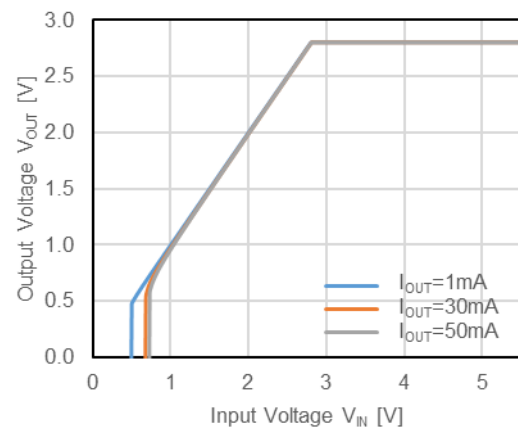

RP122x48xx

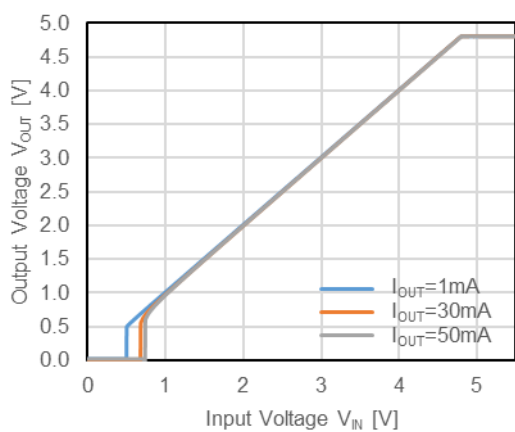

8) Supply Current vs. Input Voltage (C_{IN} = Ceramic 1.0 μ F, C_{OUT} = Ceramic 1.0 μ F, T_a = 25°C)

RP122x12xx

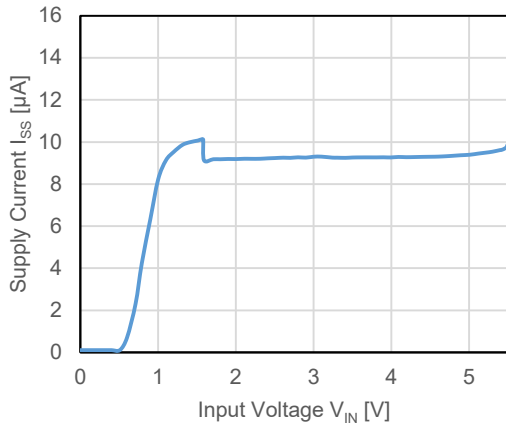

RP122x28xx

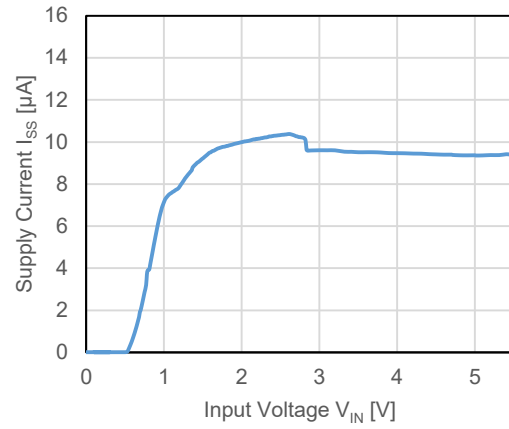

RP122x48xx

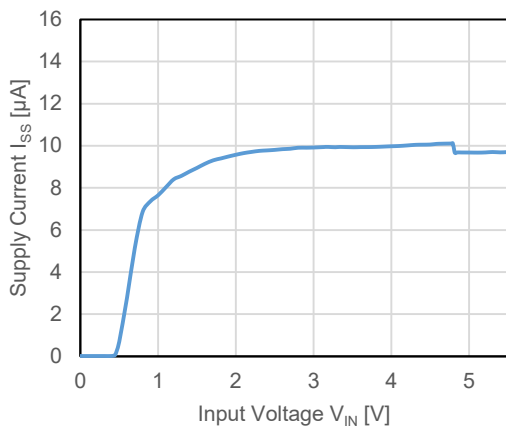

9) Supply Current vs. Output Current (C_{IN} = Ceramic 1.0 μ F, C_{OUT} = Ceramic 1.0 μ F, T_a = 25°C)

RP122x12xx, V_{IN} = 2.2 V

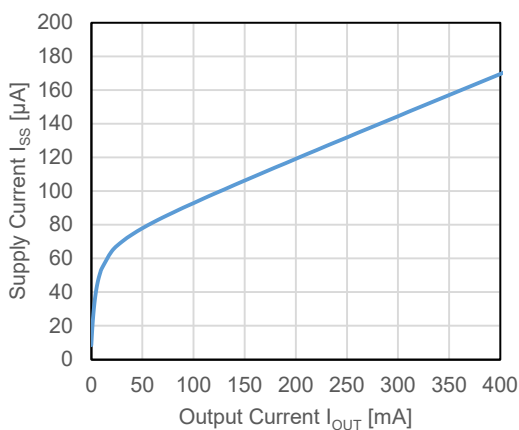

RP122x28xx, V_{IN} = 3.8 V

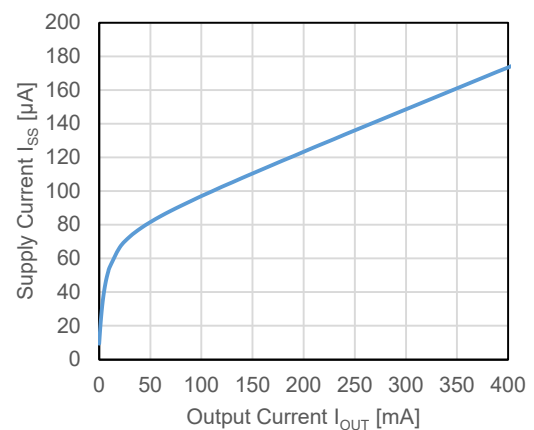

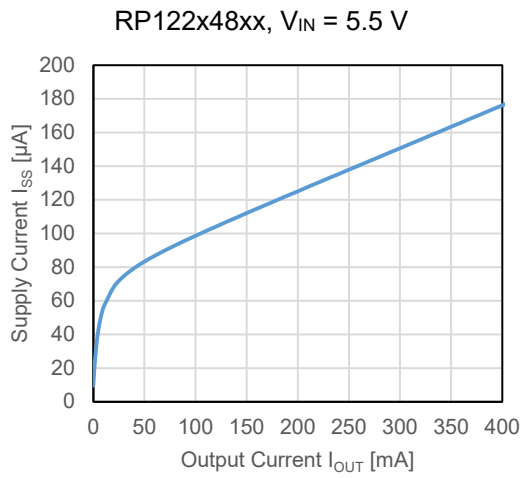

10) Ripple Rejection vs. Frequency ($C_{OUT} = \text{Ceramic } 1.0\ \mu\text{F}$, Ripple = 0.2 Vp-p, $T_a = 25^\circ\text{C}$)

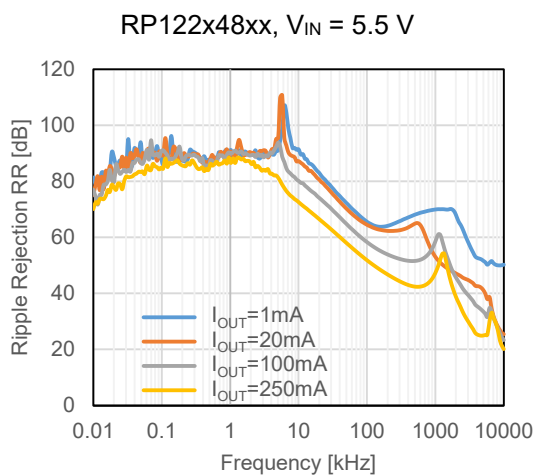
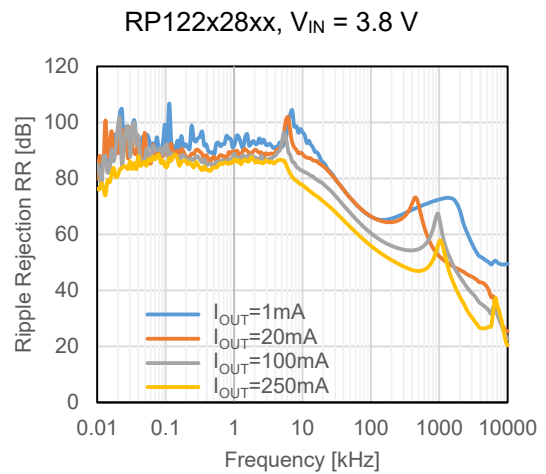
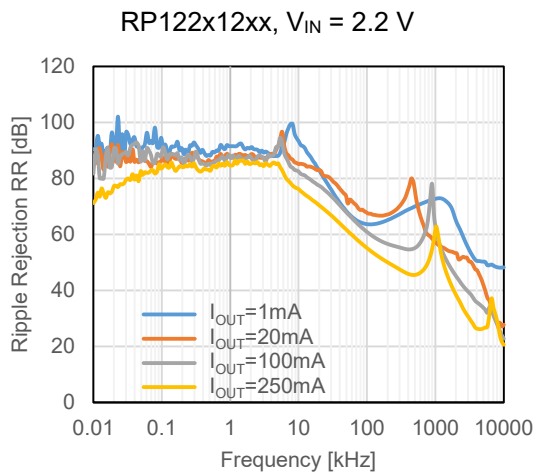

11) Ripple Rejection vs. Input Voltage ($C_{OUT} = \text{Ceramic } 1.0 \mu\text{F}$, Ripple = 0.2 Vp-p, $T_a = 25^\circ\text{C}$)

RP122x12xx, $I_{OUT} = 1 \text{ mA}$

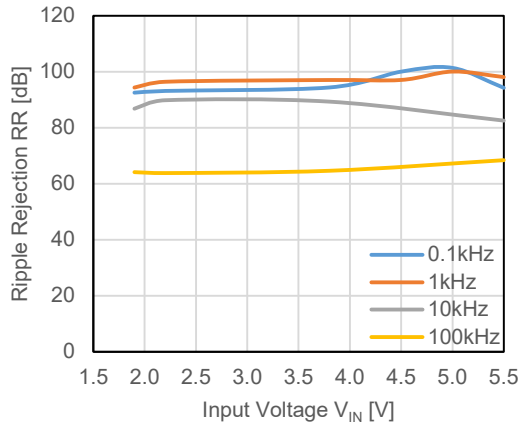

RP122x12xx, $I_{OUT} = 20 \text{ mA}$

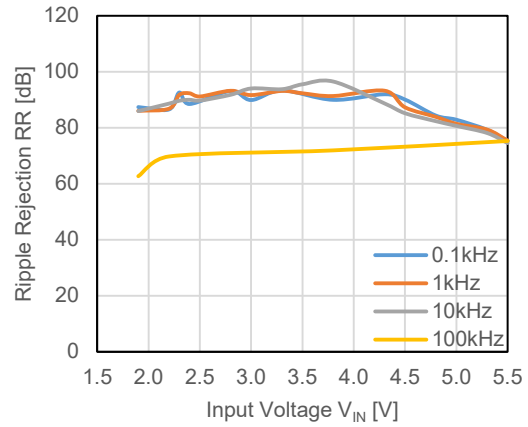

RP122x28xx, $I_{OUT} = 1 \text{ mA}$

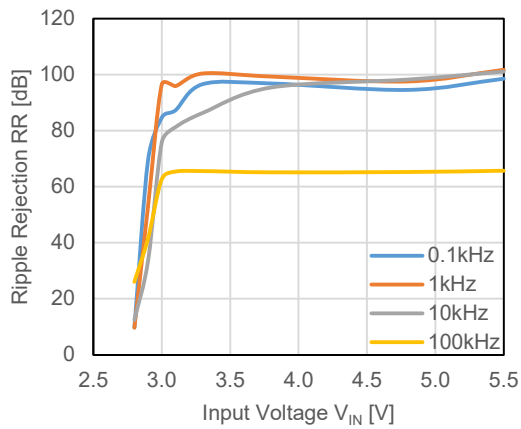

RP122x28xx, $I_{OUT} = 20 \text{ mA}$

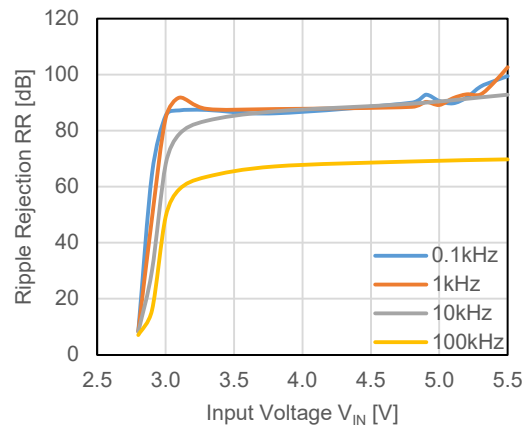

RP122x48xx, $I_{OUT} = 1 \text{ mA}$

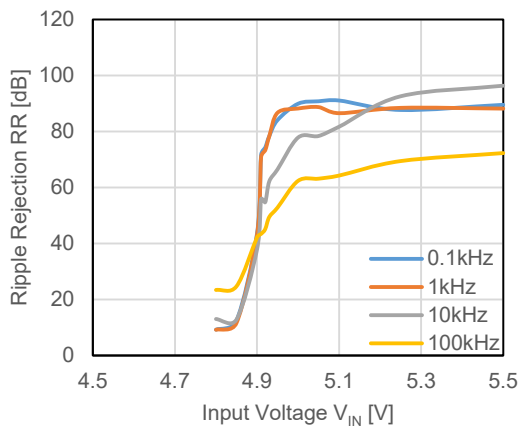

RP122x48xx, $I_{OUT} = 20 \text{ mA}$

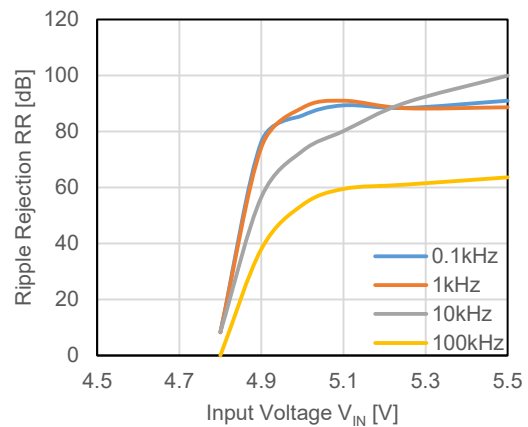

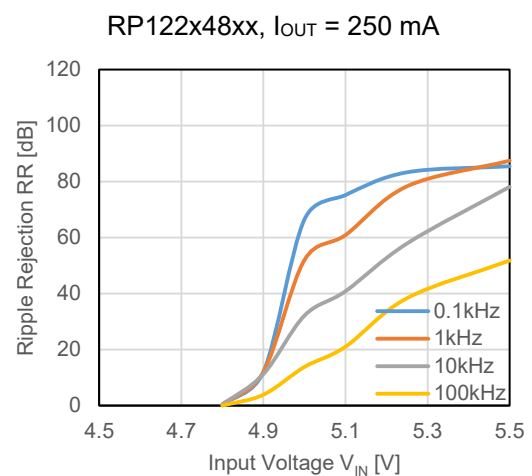
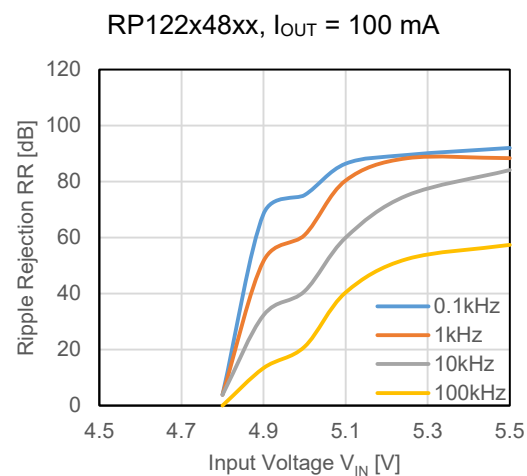
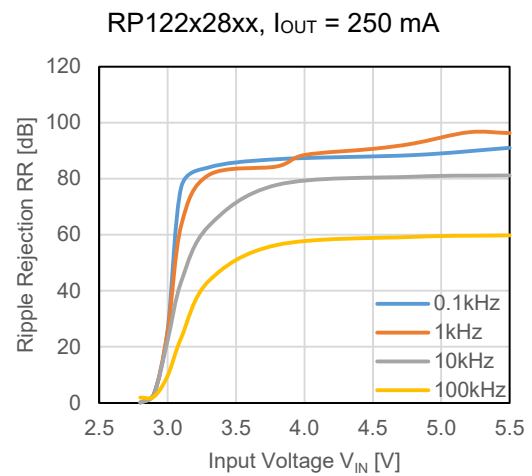
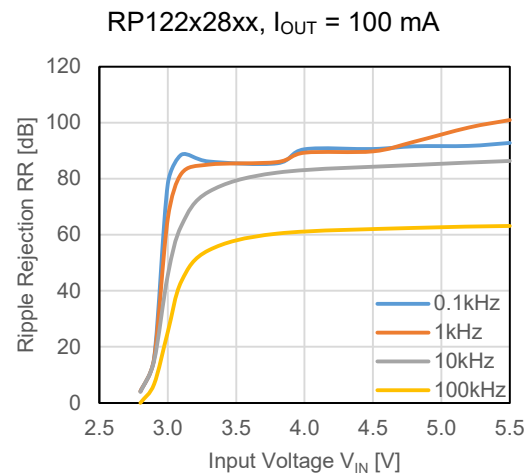
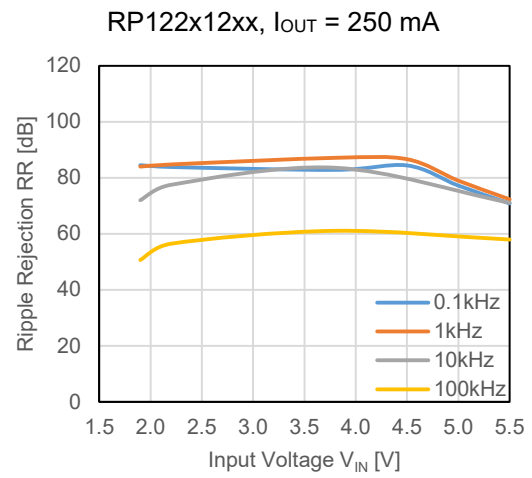
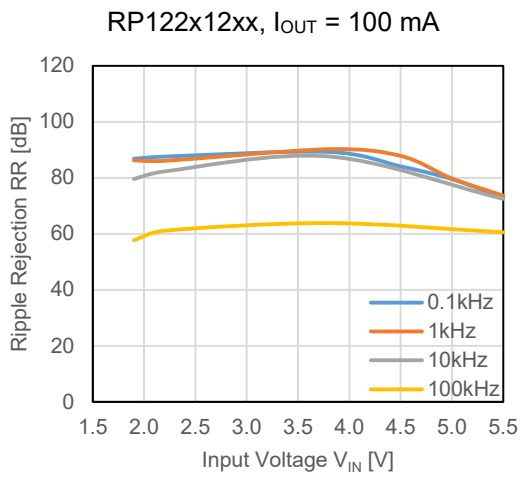

12) Output Noise Spectral Density vs. Frequency (C_{IN} =Ceramic 1.0 μ F, C_{OUT} =Ceramic 1.0 μ F, T_a =25°C)

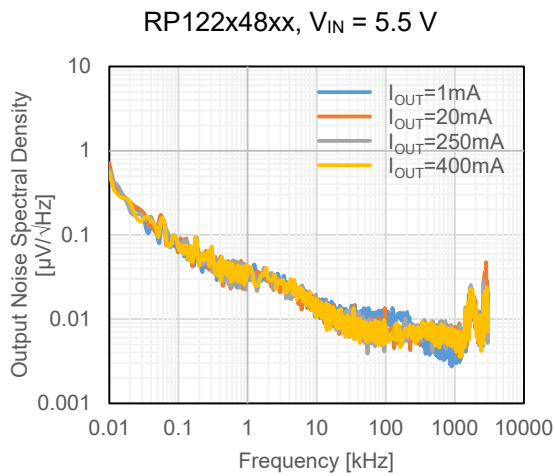
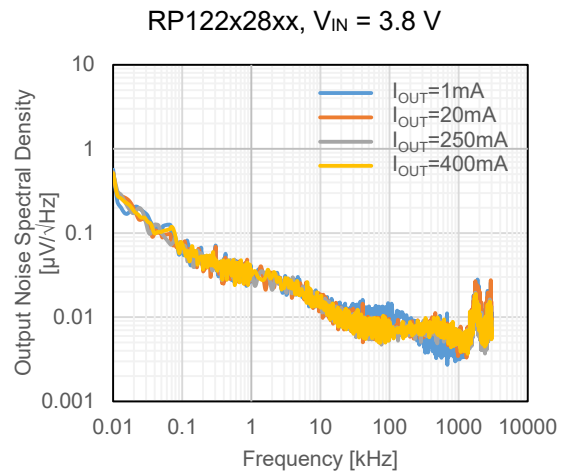
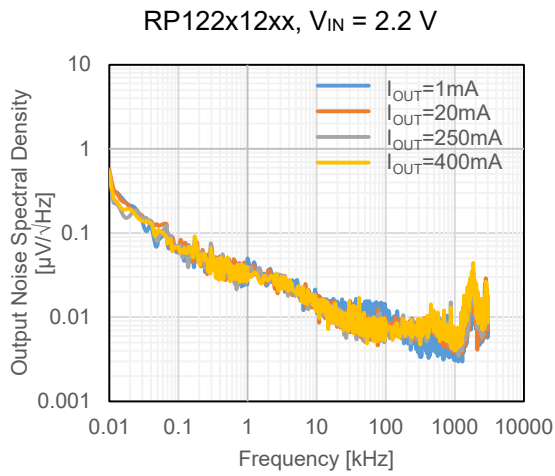

13) Input Transient Response ($C_{IN} =$ Ceramic 1.0 μ F, $C_{OUT} =$ Ceramic 1.0 μ F, $t_R = t_F = 5$ μ s, $T_a = 25^\circ$ C)

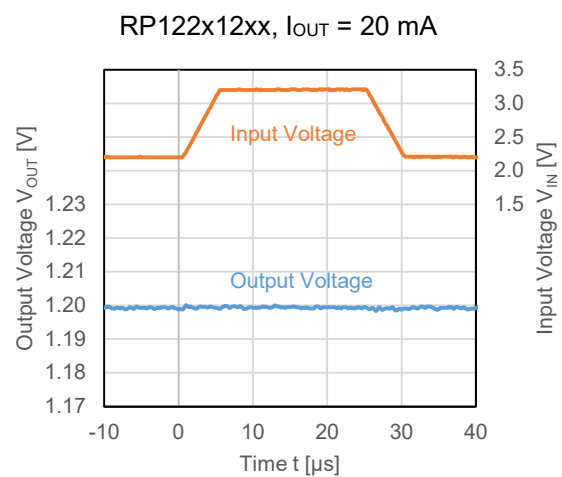
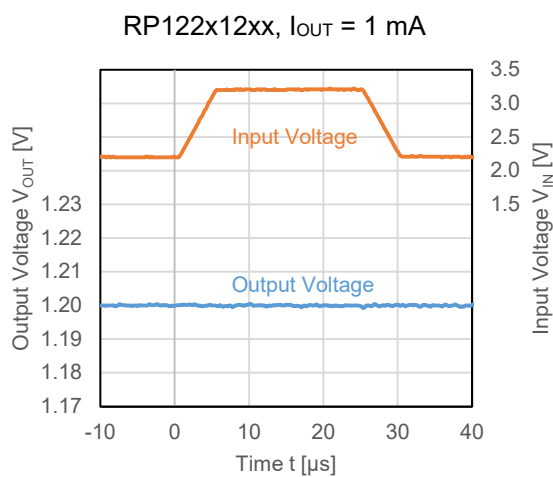

RP122x28xx, $I_{OUT} = 1 \text{ mA}$

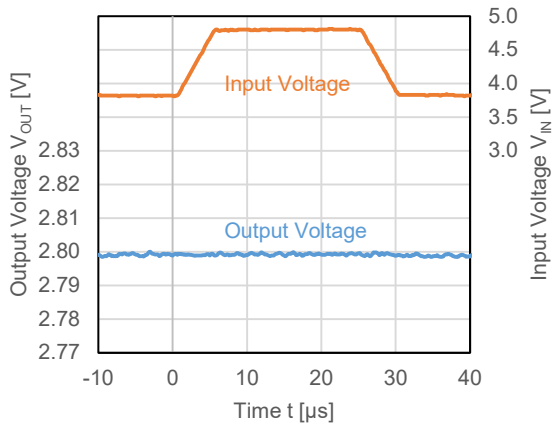

RP122x28xx, $I_{OUT} = 20 \text{ mA}$

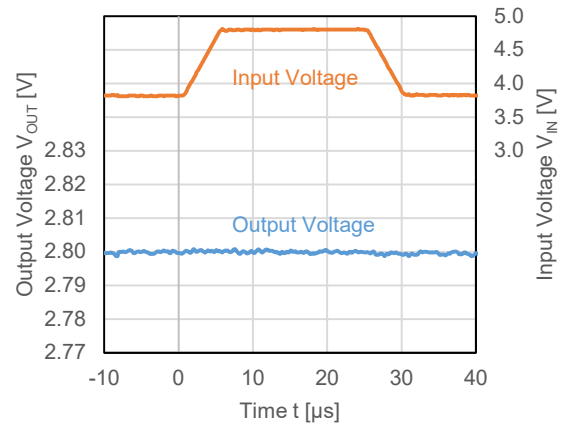

RP122x48xx, $I_{OUT} = 1 \text{ mA}$

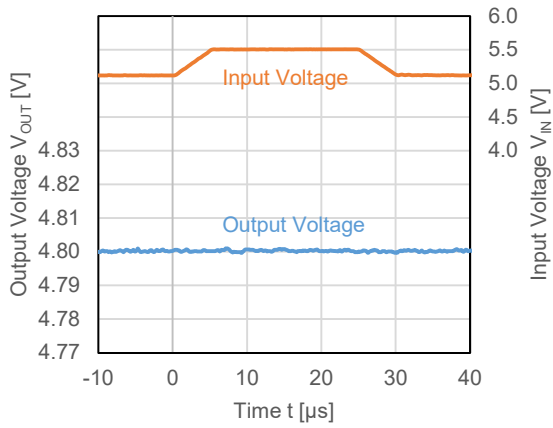

RP122x48xx, $I_{OUT} = 20 \text{ mA}$

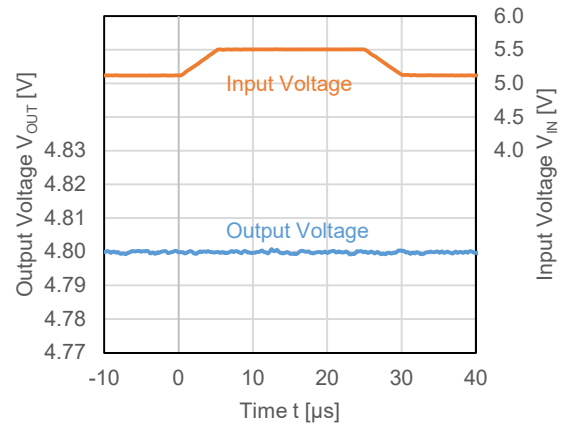

14) Load transient Response ($C_{IN} = \text{Ceramic } 1.0 \mu\text{F}$, $C_{OUT} = \text{Ceramic } 1.0 \mu\text{F}$, $T_a = 25^\circ\text{C}$)

RP122x12xx, $V_{IN} = 2.2 \text{ V}$,
 $I_{OUT} = 1 \text{ mA} \Leftrightarrow 250 \text{ mA}$, $t_R = t_F = 10 \mu\text{s}$

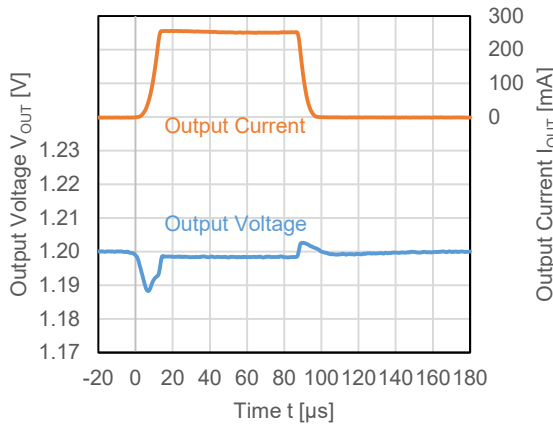

RP122x12xx, $V_{IN} = 2.2 \text{ V}$,
 $I_{OUT} = 0 \Rightarrow 400 \text{ mA}$, $t_R = 0.5 \mu\text{s}$

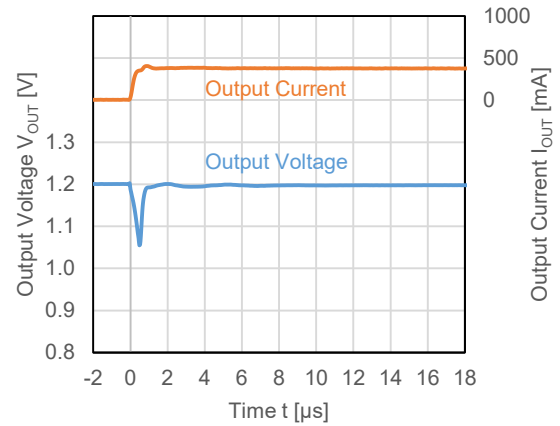

RP122x28xx, $V_{IN} = 3.8\text{ V}$,
 $I_{OUT} = 1\text{ mA} \Leftrightarrow 250\text{ mA}$, $t_R = t_F = 10\ \mu\text{s}$

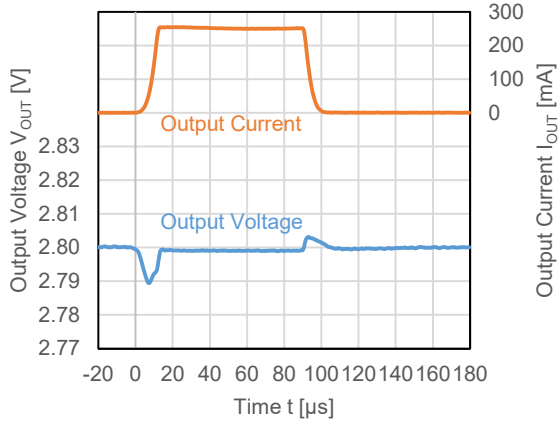

RP122x28xx, $V_{IN} = 3.8\text{ V}$,
 $I_{OUT} = 0 \Rightarrow 400\text{ mA}$, $t_R = 0.5\ \mu\text{s}$

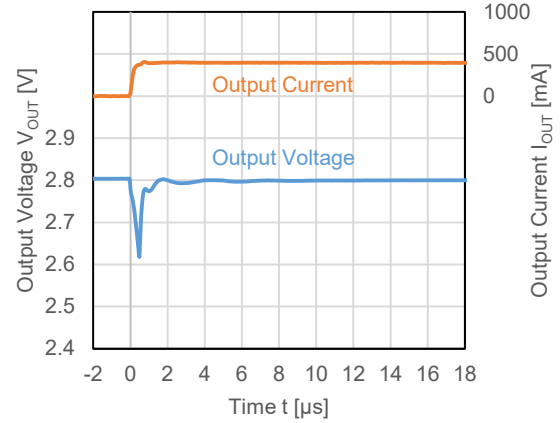

RP122x48xx, $V_{IN} = 5.5\text{ V}$,
 $I_{OUT} = 1\text{ mA} \Leftrightarrow 250\text{ mA}$, $t_R = t_F = 10\ \mu\text{s}$

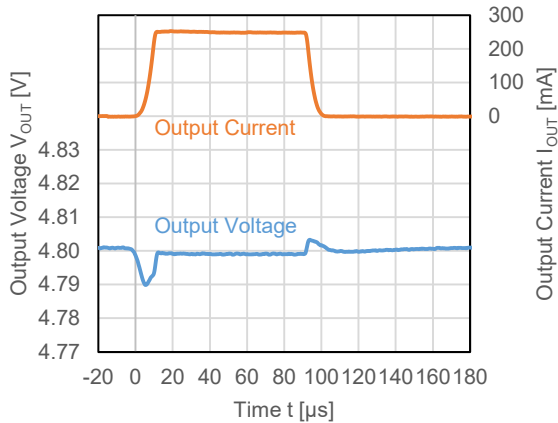

RP122x48xx, $V_{IN} = 5.5\text{ V}$,
 $I_{OUT} = 0 \Rightarrow 400\text{ mA}$, $t_R = 0.5\ \mu\text{s}$

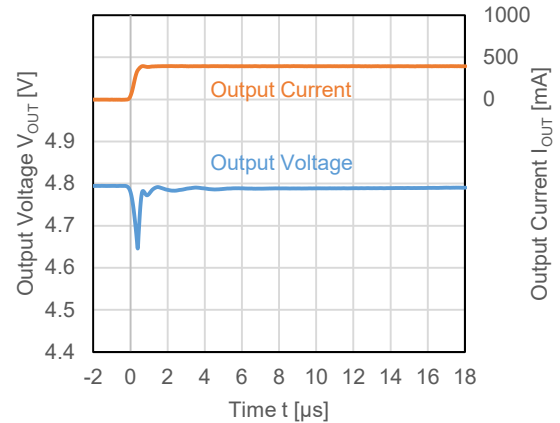

15) Turn On Speed with CE Pin ($C_{IN} = \text{Ceramic } 1.0\ \mu\text{F}$, $C_{OUT} = \text{Ceramic } 1.0\ \mu\text{F}$, $T_a = 25^\circ\text{C}$)

RP122x12xx, $V_{IN} = 2.2\text{ V}$

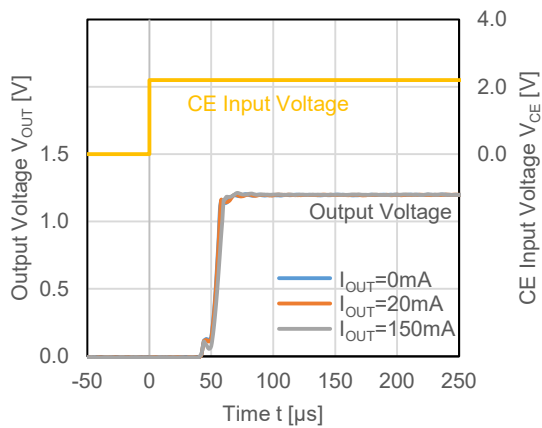

RP122x28xx, $V_{IN} = 3.8\text{ V}$

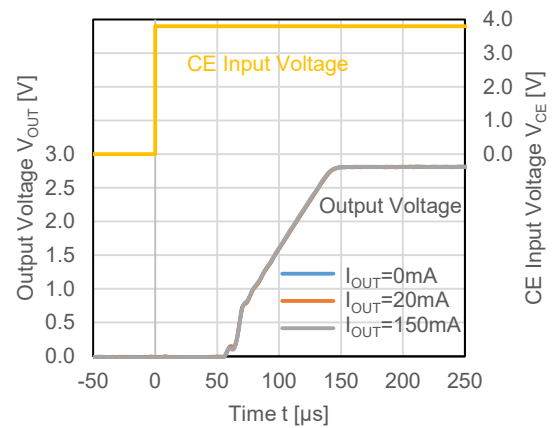

RP122x48xx, $V_{IN} = 5.5V$

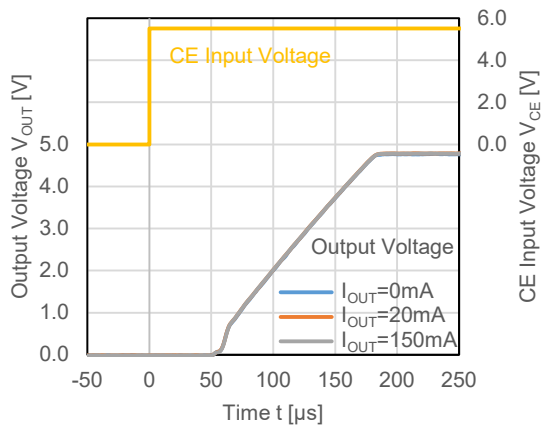

16) Turn Off Speed with CE Pin ($C_{IN} = \text{Ceramic } 1.0 \mu F$, $C_{OUT} = \text{Ceramic } 1.0 \mu F$, $T_a = 25^\circ C$)

RP122x12xD, $V_{IN} = 2.2V$

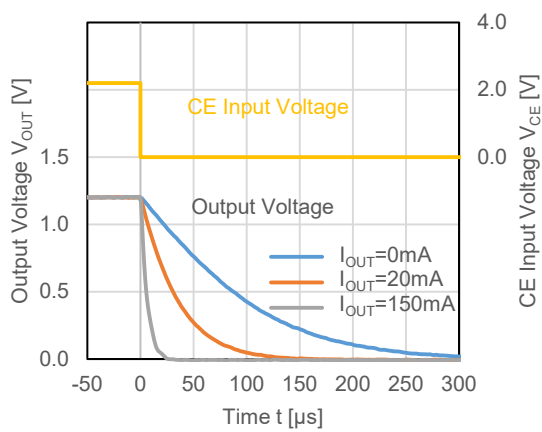

RP122x28xD, $V_{IN} = 3.8V$

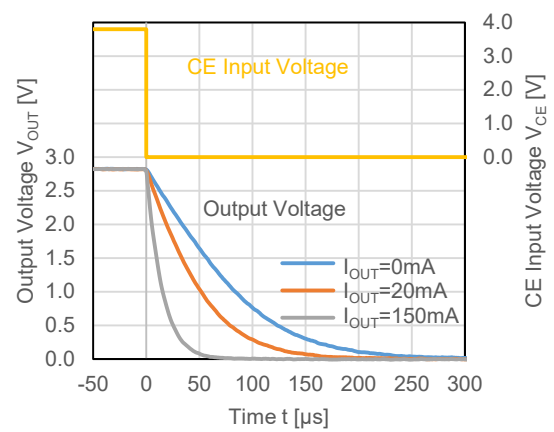

RP122x48xD, $V_{IN} = 5.5V$

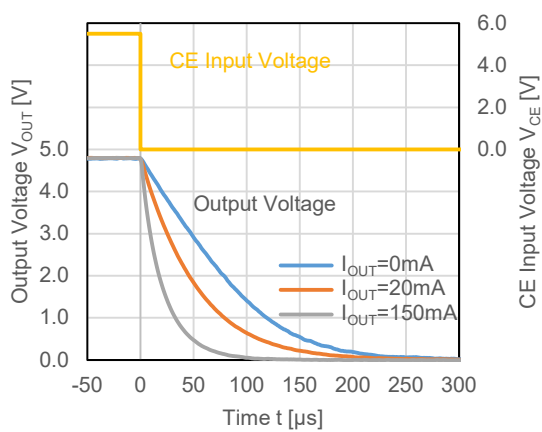

17) Inrush Current (C_{IN} = Ceramic 1.0 μF , $I_{OUT} = 0$ mA, $T_a = 25^\circ\text{C}$)

RP122x12xx, $V_{IN} = 2.2$ V

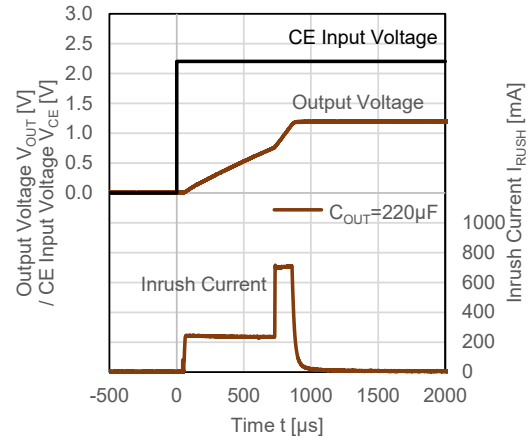
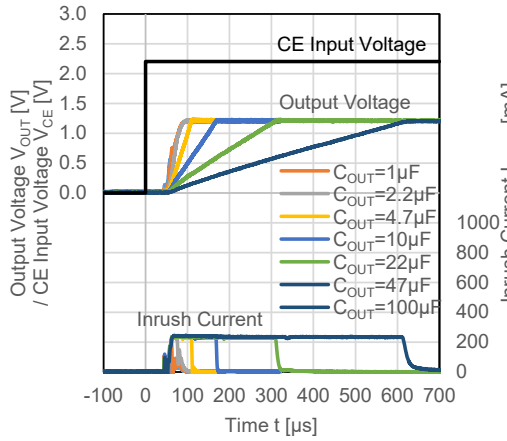

RP122x28xx, $V_{IN} = 3.8$ V

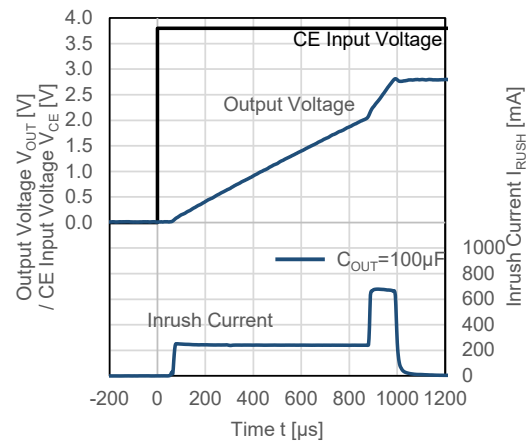
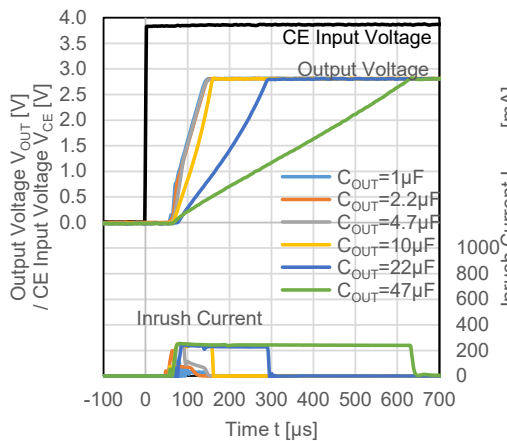

RP122x48xx, $V_{IN} = 5.5$ V

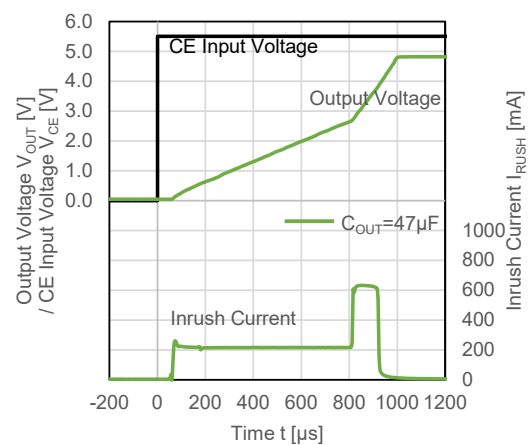
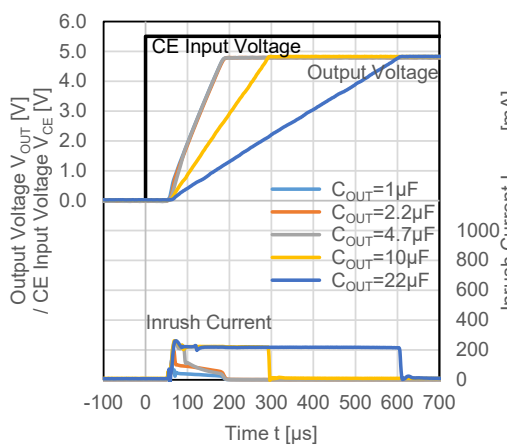

The power dissipation of the package is dependent on PCB material, layout, and environmental conditions. The following measurement conditions are based on JEDEC STD. 51-9.

Measurement Conditions

Item	Measurement Conditions
Environment	Mounting on Board (Wind Velocity = 0 m/s)
Board Material	Glass Cloth Epoxy Plastic (Four-Layer Board)
Board Dimensions	101.5 mm x 114.5 mm x 1.6 mm
Copper Ratio	Outer Layer (First Layer): 60% Inner Layers (Second and Third Layers): 100% Outer Layer (Fourth Layer): 60%

Measurement Result

(Ta = 25°C, Tjmax = 125°C)

Item	Measurement Result
Power Dissipation	520 mW
Thermal Resistance (θ_{ja})	$\theta_{ja} = 192^\circ\text{C/W}$

θ_{ja} : Junction-to-Ambient Thermal Resistance

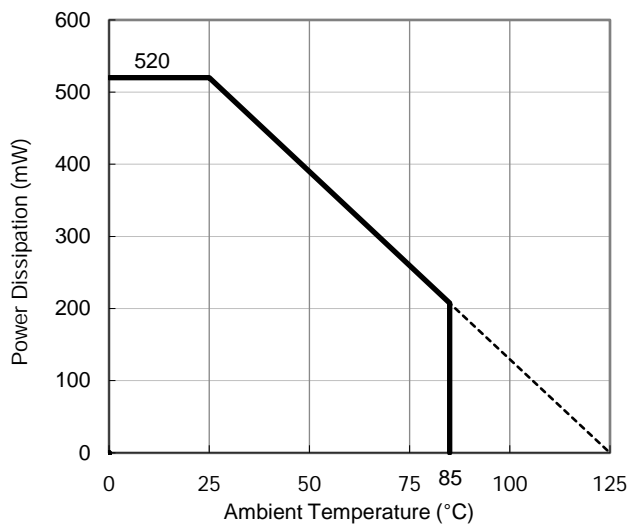

Power Dissipation vs. Ambient Temperature

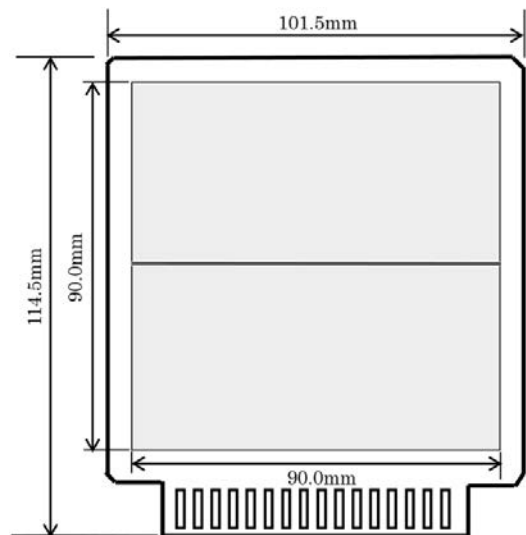

Measurement Board Pattern

The power dissipation of the package is dependent on PCB material, layout, and environmental conditions. The following measurement conditions are based on JEDEC STD. 51.

Measurement Conditions

Item	Measurement Conditions
Environment	Mounting on Board (Wind Velocity = 0 m/s)
Board Material	Glass Cloth Epoxy Plastic (Four-Layer Board)
Board Dimensions	101.5 mm x 114.5 mm x 1.6 mm
Copper Ratio	Outer Layer (First Layer): 60% Inner Layers (Second and Third Layers): 100% Outer Layer (Fourth Layer): 60%

Measurement Result

(Ta = 25°C, Tjmax = 125°C)

Item	Measurement Result
Power Dissipation	520 mW
Thermal Resistance (θ_{ja})	$\theta_{ja} = 192^\circ\text{C/W}$

θ_{ja} : Junction-to-Ambient Thermal Resistance

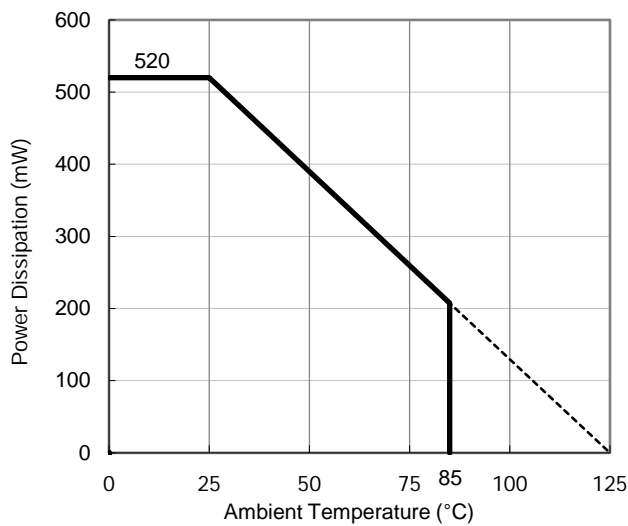

Power Dissipation vs. Ambient Temperature

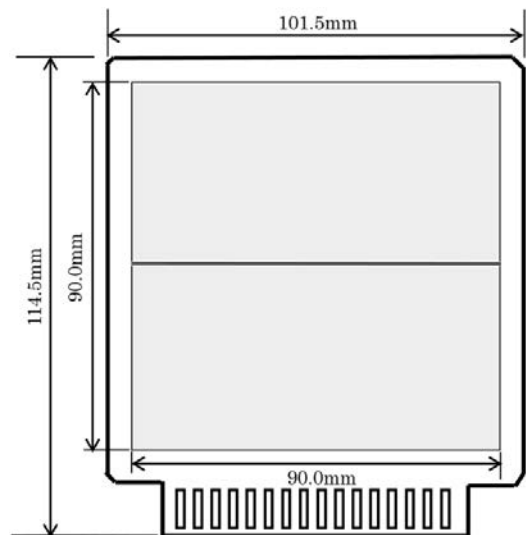

Measurement Board Pattern

PACKAGE DIMENSIONS

WLCSP-4-P12

DM-WLCSP-4-P12-JE-A

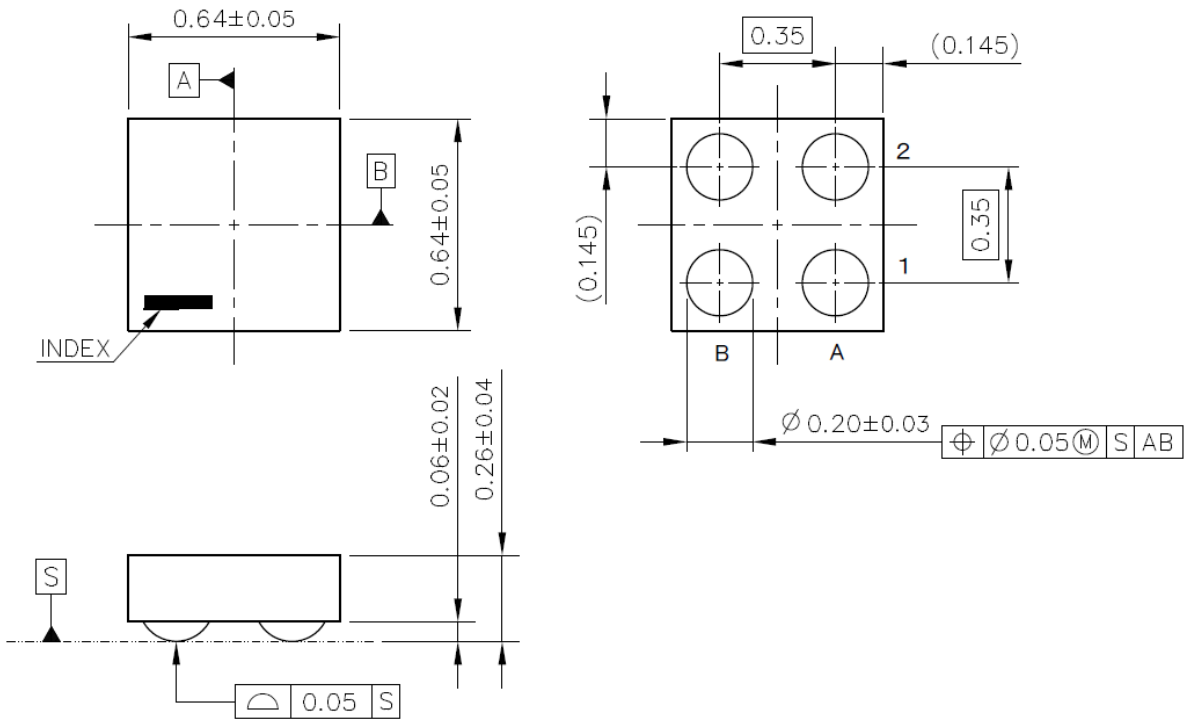

UNIT: mm

WLCSP-4-P12 Package Dimensions

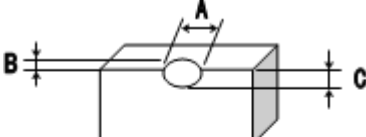
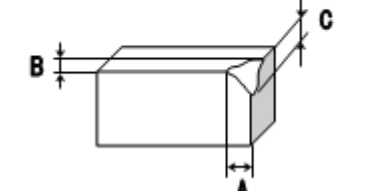
No.	Inspection Items	Inspection Criteria	Figure
1	Package chipping	<p>$A \geq 0.2\text{mm}$ is rejected $B \geq 0.2\text{mm}$ is rejected $C \geq 0.2\text{mm}$ is rejected And, Package chipping to Si surface and to bump is rejected.</p>	
2	Si surface chipping	<p>$A \geq 0.2\text{mm}$ is rejected $B \geq 0.2\text{mm}$ is rejected $C \geq 0.2\text{mm}$ is rejected But, even if $A \geq 0.2\text{mm}$, $B \leq 0.1\text{mm}$ is acceptable.</p>	
3	No bump	No bump is rejected.	
4	Marking miss	To reject incorrect marking, such as another product name marking or another lot No. marking.	
5	No marking	To reject no marking on the package.	
6	Reverse direction of marking	To reject reverse direction of marking character.	
7	Defective marking	To reject unreadable marking. (Microscope: X15/ White LED/ Viewed from vertical direction)	
8	Scratch	To reject unreadable marking character by scratch. (Microscope: X15/ White LED/ Viewed from vertical direction)	
9	Stain and Foreign material	To reject unreadable marking character by stain and foreign material. (Microscope: X15/ White LED/ Viewed from vertical direction)	

①②: Lot Number ... Alphanumeric Serial Number

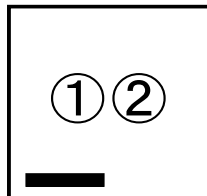

RP122Z (WLCSP-4-P8 / WLCSP-4-P12) Part Markings

NOTICE

There can be variation in the marking when different AOI (Automated Optical Inspection) equipment is used. In the case of recognizing the marking characteristic with AOI, please contact our sales or our distributor before attempting to use AOI.

PART MARKINGS

RP122Z

MK-RP122Z-JAEA-E

RP122Z Part Marking List: RP122Zxx1x, RP122Zxx3x

Product Name	① ②	Product Name	① ②	Set Voltage
RP122Z12xB	Lot No.	RP122Z12xD	Lot No.	1.20 V
RP122Z13xB	Lot No.	RP122Z13xD	Lot No.	1.30 V
RP122Z14xB	Lot No.	RP122Z14xD	Lot No.	1.40 V
RP122Z15xB	Lot No.	RP122Z15xD	Lot No.	1.50 V
RP122Z16xB	Lot No.	RP122Z16xD	Lot No.	1.60 V
RP122Z17xB	Lot No.	RP122Z17xD	Lot No.	1.70 V
RP122Z18xB	Lot No.	RP122Z18xD	Lot No.	1.80 V
RP122Z19xB	Lot No.	RP122Z19xD	Lot No.	1.90 V
RP122Z20xB	Lot No.	RP122Z20xD	Lot No.	2.00 V
RP122Z21xB	Lot No.	RP122Z21xD	Lot No.	2.10 V
RP122Z22xB	Lot No.	RP122Z22xD	Lot No.	2.20 V
RP122Z23xB	Lot No.	RP122Z23xD	Lot No.	2.30 V
RP122Z24xB	Lot No.	RP122Z24xD	Lot No.	2.40 V
RP122Z25xB	Lot No.	RP122Z25xD	Lot No.	2.50 V
RP122Z26xB	Lot No.	RP122Z26xD	Lot No.	2.60 V
RP122Z27xB	Lot No.	RP122Z27xD	Lot No.	2.70 V
RP122Z28xB	Lot No.	RP122Z28xD	Lot No.	2.80 V
RP122Z29xB	Lot No.	RP122Z29xD	Lot No.	2.90 V
RP122Z30xB	Lot No.	RP122Z30xD	Lot No.	3.00 V
RP122Z31xB	Lot No.	RP122Z31xD	Lot No.	3.10 V
RP122Z32xB	Lot No.	RP122Z32xD	Lot No.	3.20 V
RP122Z33xB	Lot No.	RP122Z33xD	Lot No.	3.30 V
RP122Z34xB	Lot No.	RP122Z34xD	Lot No.	3.40 V
RP122Z35xB	Lot No.	RP122Z35xD	Lot No.	3.50 V
RP122Z36xB	Lot No.	RP122Z36xD	Lot No.	3.60 V
RP122Z37xB	Lot No.	RP122Z37xD	Lot No.	3.70 V
RP122Z38xB	Lot No.	RP122Z38xD	Lot No.	3.80 V
RP122Z39xB	Lot No.	RP122Z39xD	Lot No.	3.90 V
RP122Z40xB	Lot No.	RP122Z40xD	Lot No.	4.00 V
RP122Z41xB	Lot No.	RP122Z41xD	Lot No.	4.10 V
RP122Z42xB	Lot No.	RP122Z42xD	Lot No.	4.20 V
RP122Z43xB	Lot No.	RP122Z43xD	Lot No.	4.30 V
RP122Z44xB	Lot No.	RP122Z44xD	Lot No.	4.40 V
RP122Z45xB	Lot No.	RP122Z45xD	Lot No.	4.50 V
RP122Z46xB	Lot No.	RP122Z46xD	Lot No.	4.60 V
RP122Z47xB	Lot No.	RP122Z47xD	Lot No.	4.70 V
RP122Z48xB	Lot No.	RP122Z48xD	Lot No.	4.80 V
RP122Z12xB5	Lot No.	RP122Z12xD5	Lot No.	1.25 V
RP122Z18xB5	Lot No.	RP122Z18xD5	Lot No.	1.85 V
RP122Z28xB5	Lot No.	RP122Z28xD5	Lot No.	2.85 V
RP122Z45xB5	Lot No.	RP122Z45xD5	Lot No.	4.55 V
RP122Z29xB5	Lot No.	RP122Z29xD5	Lot No.	2.95 V
RP122Z31xB5	Lot No.	RP122Z31xD5	Lot No.	3.15 V
RP122Z42xB5	Lot No.	RP122Z42xD5	Lot No.	4.25 V
RP122Z30xB5	Lot No.	RP122Z30xD5	Lot No.	3.05 V

The power dissipation of the package is dependent on PCB material, layout, and environmental conditions. The following measurement conditions are based on JEDEC STD. 51-7.

Measurement Conditions

Item	Measurement Conditions
Environment	Mounting on Board (Wind Velocity = 0 m/s)
Board Material	Glass Cloth Epoxy Plastic (Four-Layer Board)
Board Dimensions	76.2 mm × 114.3 mm × 0.8 mm
Copper Ratio	Outer Layer (First Layer): Less than 95% of 50 mm Square Inner Layers (Second and Third Layers): Approx. 100% of 50 mm Square Outer Layer (Fourth Layer): Approx. 100% of 50 mm Square
Through-holes	φ 0.2 mm × 21 pcs

Measurement Result

(Ta = 25°C, Tjmax = 125°C)

Item	Measurement Result
Power Dissipation	550 mW
Thermal Resistance (θja)	θja = 180°C/W
Thermal Characterization Parameter (ψjt)	ψjt = 105°C/W

θja: Junction-to-Ambient Thermal Resistance

ψjt: Junction-to-Top Thermal Characterization Parameter

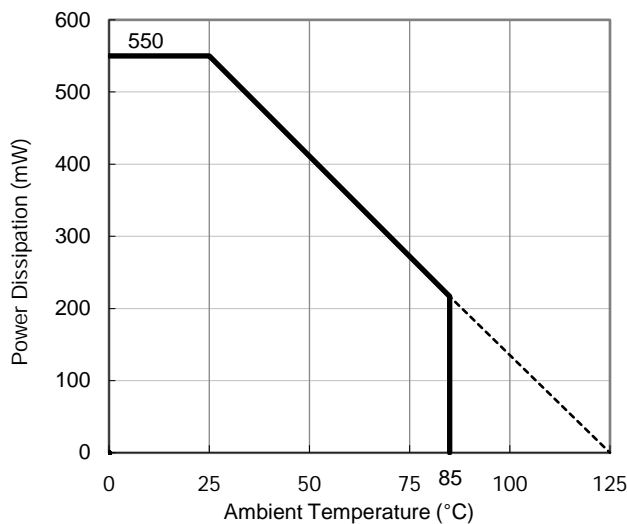

Power Dissipation vs. Ambient Temperature

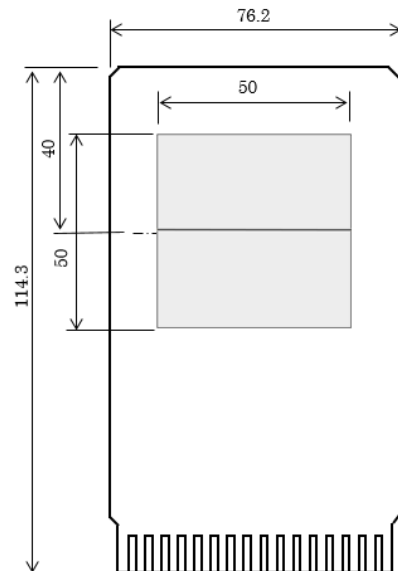

Measurement Board Pattern

①②: Product Code ... Refer to *Part Marking List*

③④: Lot Number ... Alphanumeric Serial Number

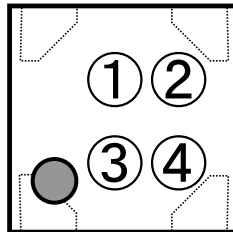

RP122K (DFN(PL)1010-4B) Part Markings

NOTICE

There can be variation in the marking when different AOI (Automated Optical Inspection) equipment is used. In the case of recognizing the marking characteristic with AOI, please contact our sales or distributor before attempting to use AOI.

PART MARKINGS

RP122K

MK-RP122K-JAEA-G

RP122Kxx1x Part Marking List

Product Name	①	②	Product Name	①	②	V _{SET}
RP122K121B	L	0	RP122K121D	R	0	1.20 V
RP122K131B	L	1	RP122K131D	R	1	1.30 V
RP122K141B	L	2	RP122K141D	R	2	1.40 V
RP122K151B	L	3	RP122K151D	R	3	1.50 V
RP122K161B	L	4	RP122K161D	R	4	1.60 V
RP122K171B	L	5	RP122K171D	R	5	1.70 V
RP122K181B	L	6	RP122K181D	R	6	1.80 V
RP122K191B	L	7	RP122K191D	R	7	1.90 V
RP122K201B	L	8	RP122K201D	R	8	2.00 V
RP122K211B	L	9	RP122K211D	R	9	2.10 V
RP122K221B	M	0	RP122K221D	S	0	2.20 V
RP122K231B	M	1	RP122K231D	S	1	2.30 V
RP122K241B	M	2	RP122K241D	S	2	2.40 V
RP122K251B	M	3	RP122K251D	S	3	2.50 V
RP122K261B	M	4	RP122K261D	S	4	2.60 V
RP122K271B	M	5	RP122K271D	S	5	2.70 V
RP122K281B	M	6	RP122K281D	S	6	2.80 V
RP122K291B	M	7	RP122K291D	S	7	2.90 V
RP122K301B	M	8	RP122K301D	S	8	3.00 V
RP122K311B	M	9	RP122K311D	S	9	3.10 V
RP122K321B	N	0	RP122K321D	T	0	3.20 V
RP122K331B	N	1	RP122K331D	T	1	3.30 V
RP122K341B	N	2	RP122K341D	T	2	3.40 V
RP122K351B	N	3	RP122K351D	T	3	3.50 V
RP122K361B	N	4	RP122K361D	T	4	3.60 V
RP122K371B	N	5	RP122K371D	T	5	3.70 V
RP122K381B	N	6	RP122K381D	T	6	3.80 V
RP122K391B	N	7	RP122K391D	T	7	3.90 V
RP122K401B	N	8	RP122K401D	T	8	4.00 V
RP122K411B	N	9	RP122K411D	T	9	4.10 V
RP122K421B	P	0	RP122K421D	U	0	4.20 V
RP122K431B	P	1	RP122K431D	U	1	4.30 V
RP122K441B	P	2	RP122K441D	U	2	4.40 V
RP122K451B	P	3	RP122K451D	U	3	4.50 V
RP122K461B	P	4	RP122K461D	U	4	4.60 V
RP122K471B	P	5	RP122K471D	U	5	4.70 V
RP122K481B	P	6	RP122K481D	U	6	4.80 V
RP122K121B5	P	7	RP122K121D5	U	7	1.25 V
RP122K181B5	P	8	RP122K181D5	U	8	1.85 V
RP122K281B5	P	9	RP122K281D5	U	9	2.85 V
RP122K451B5	W	0	RP122K451D5	V	0	4.55 V
RP122K291B5	W	1	RP122K291D5	V	1	2.95 V
RP122K311B5	W	2	RP122K311D5	V	2	3.15 V
RP122K421B5	W	3	RP122K421D5	V	3	4.25 V
RP122K301B5	W	4	RP122K301D5	V	4	3.05 V

The power dissipation of the package is dependent on PCB material, layout, and environmental conditions. The following measurement conditions are based on JEDEC STD. 51-7.

Measurement Conditions

Item	Measurement Conditions
Environment	Mounting on Board (Wind Velocity = 0 m/s)
Board Material	Glass Cloth Epoxy Plastic (Four-Layer Board)
Board Dimensions	76.2 mm × 114.3 mm × 0.8 mm
Copper Ratio	Outer Layer (First Layer): Less than 95% of 50 mm Square Inner Layers (Second and Third Layers): Approx. 100% of 50 mm Square Outer Layer (Fourth Layer): Approx. 100% of 50 mm Square
Through-holes	φ 0.3 mm × 7 pcs

Measurement Result

(Ta = 25°C, Tjmax = 125°C)

Item	Measurement Result
Power Dissipation	660 mW
Thermal Resistance (θja)	θja = 150°C/W
Thermal Characterization Parameter (ψjt)	ψjt = 51°C/W

θja: Junction-to-Ambient Thermal Resistance

ψjt: Junction-to-Top Thermal Characterization Parameter

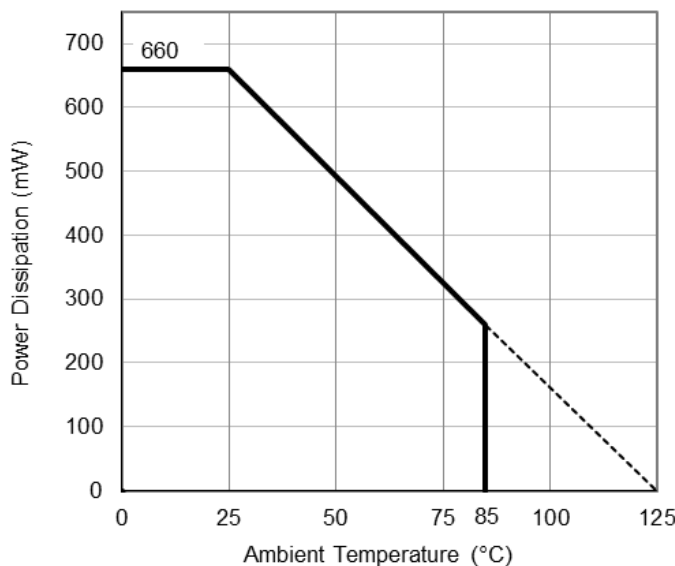

Power Dissipation vs. Ambient Temperature

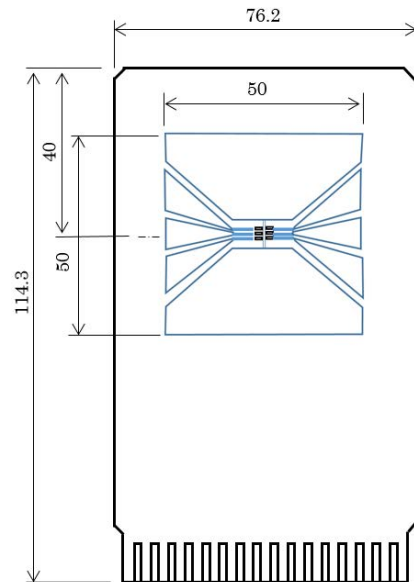

Measurement Board Pattern

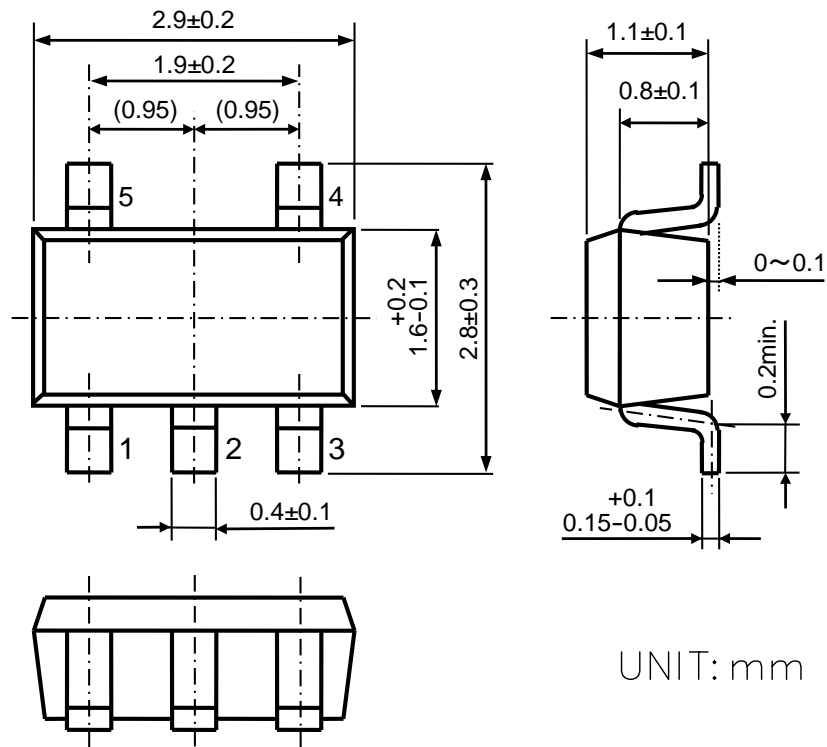

UNIT: mm

SOT-23-5 Package Dimensions

①②③: Product Code ... Refer to *Part Marking List*

④⑤: Lot Number ... Alphanumeric Serial Number

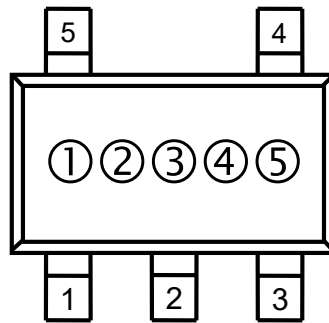

RP122N (SOT-23-5) Part Markings

NOTICE

There can be variation in the marking when different AOI (Automated Optical Inspection) equipment is used. In the case of recognizing the marking characteristic with AOI, please contact our sales or our distributor before attempting to use AOI.

PART MARKINGS

RP122N

MK-RP122N-JAEA-A

RP122Nxx1x Part Marking List

Product Name	①	②	③	Product Name	①	②	③	V _{SET}
RP122N121B	1	A	0	RP122N121D	3	A	0	1.20 V
RP122N131B	1	A	1	RP122N131D	3	A	1	1.30 V
RP122N141B	1	A	2	RP122N141D	3	A	2	1.40 V
RP122N151B	1	A	3	RP122N151D	3	A	3	1.50 V
RP122N161B	1	A	4	RP122N161D	3	A	4	1.60 V
RP122N171B	1	A	5	RP122N171D	3	A	5	1.70 V
RP122N181B	1	A	6	RP122N181D	3	A	6	1.80 V
RP122N191B	1	A	7	RP122N191D	3	A	7	1.90 V
RP122N201B	1	A	8	RP122N201D	3	A	8	2.00 V
RP122N211B	1	A	9	RP122N211D	3	A	9	2.10 V
RP122N221B	1	B	0	RP122N221D	3	B	0	2.20 V
RP122N231B	1	B	1	RP122N231D	3	B	1	2.30 V
RP122N241B	1	B	2	RP122N241D	3	B	2	2.40 V
RP122N251B	1	B	3	RP122N251D	3	B	3	2.50 V
RP122N261B	1	B	4	RP122N261D	3	B	4	2.60 V
RP122N271B	1	B	5	RP122N271D	3	B	5	2.70 V
RP122N281B	1	B	6	RP122N281D	3	B	6	2.80 V
RP122N291B	1	B	7	RP122N291D	3	B	7	2.90 V
RP122N301B	1	B	8	RP122N301D	3	B	8	3.00 V
RP122N311B	1	B	9	RP122N311D	3	B	9	3.10 V
RP122N321B	1	C	0	RP122N321D	3	C	0	3.20 V
RP122N331B	1	C	1	RP122N331D	3	C	1	3.30 V
RP122N341B	1	C	2	RP122N341D	3	C	2	3.40 V
RP122N351B	1	C	3	RP122N351D	3	C	3	3.50 V
RP122N361B	1	C	4	RP122N361D	3	C	4	3.60 V
RP122N371B	1	C	5	RP122N371D	3	C	5	3.70 V
RP122N381B	1	C	6	RP122N381D	3	C	6	3.80 V
RP122N391B	1	C	7	RP122N391D	3	C	7	3.90 V
RP122N401B	1	C	8	RP122N401D	3	C	8	4.00 V
RP122N411B	1	C	9	RP122N411D	3	C	9	4.10 V
RP122N421B	1	D	0	RP122N421D	3	D	0	4.20 V
RP122N431B	1	D	1	RP122N431D	3	D	1	4.30 V
RP122N441B	1	D	2	RP122N441D	3	D	2	4.40 V
RP122N451B	1	D	3	RP122N451D	3	D	3	4.50 V
RP122N461B	1	D	4	RP122N461D	3	D	4	4.60 V
RP122N471B	1	D	5	RP122N471D	3	D	5	4.70 V
RP122N481B	1	D	6	RP122N481D	3	D	6	4.80 V
RP122N121B5	2	A	0	RP122N121D5	4	A	0	1.25 V
RP122N181B5	2	A	1	RP122N181D5	4	A	1	1.85 V
RP122N281B5	2	A	2	RP122N281D5	4	A	2	2.85 V
RP122N451B5	2	A	3	RP122N451D5	4	A	3	4.55 V
RP122N291B5	2	A	4	RP122N291D5	4	A	4	2.95 V
RP122N311B5	2	A	5	RP122N311D5	4	A	5	3.15 V
RP122N421B5	2	A	6	RP122N421D5	4	A	6	4.25 V
RP122N301B5	2	A	7	RP122N301D5	4	A	7	3.05 V

1. The products and the product specifications described in this document are subject to change or discontinuation of production without notice for reasons such as improvement. Therefore, before deciding to use the products, please refer to our sales representatives for the latest information thereon.
2. The materials in this document may not be copied or otherwise reproduced in whole or in part without the prior written consent of us.
3. This product and any technical information relating thereto are subject to complementary export controls (so-called KNOW controls) under the Foreign Exchange and Foreign Trade Law, and related politics ministerial ordinance of the law. (Note that the complementary export controls are inapplicable to any application-specific products, except rockets and pilotless aircraft, that are insusceptible to design or program changes.) Accordingly, when exporting or carrying abroad this product, follow the Foreign Exchange and Foreign Trade Control Law and its related regulations with respect to the complementary export controls.
4. The technical information described in this document shows typical characteristics and example application circuits for the products. The release of such information is not to be construed as a warranty of or a grant of license under our or any third party's intellectual property rights or any other rights.
5. The products listed in this document are intended and designed for use as general electronic components in standard applications (office equipment, telecommunication equipment, measuring instruments, consumer electronic products, amusement equipment etc.). Those customers intending to use a product in an application requiring extreme quality and reliability, for example, in a highly specific application where the failure or misoperation of the product could result in human injury or death should first contact us.
 - Aerospace Equipment
 - Equipment Used in the Deep Sea
 - Power Generator Control Equipment (nuclear, steam, hydraulic, etc.)
 - Life Maintenance Medical Equipment
 - Fire Alarms / Intruder Detectors
 - Vehicle Control Equipment (automotive, airplane, railroad, ship, etc.)
 - Various Safety Devices
 - Traffic control system
 - Combustion equipment

In case your company desires to use this product for any applications other than general electronic equipment mentioned above, make sure to contact our company in advance. Note that the important requirements mentioned in this section are not applicable to cases where operation requirements such as application conditions are confirmed by our company in writing after consultation with your company.

6. We are making our continuous effort to improve the quality and reliability of our products, but semiconductor products are likely to fail with certain probability. In order to prevent any injury to persons or damages to property resulting from such failure, customers should be careful enough to incorporate safety measures in their design, such as redundancy feature, fire containment feature and fail-safe feature. We do not assume any liability or responsibility for any loss or damage arising from misuse or inappropriate use of the products.
7. The products have been designed and tested to function within controlled environmental conditions. Do not use products under conditions that deviate from methods or applications specified in this datasheet. Failure to employ the products in the proper applications can lead to deterioration, destruction or failure of the products. We shall not be responsible for any bodily injury, fires or accident, property damage or any consequential damages resulting from misuse or misapplication of the products.
8. **Quality Warranty**
 - 8-1. **Quality Warranty Period**

In the case of a product purchased through an authorized distributor or directly from us, the warranty period for this product shall be one (1) year after delivery to your company. For defective products that occurred during this period, we will take the quality warranty measures described in section 8-2. However, if there is an agreement on the warranty period in the basic transaction agreement, quality assurance agreement, delivery specifications, etc., it shall be followed.
 - 8-2. **Quality Warranty Remedies**

When it has been proved defective due to manufacturing factors as a result of defect analysis by us, we will either deliver a substitute for the defective product or refund the purchase price of the defective product.

Note that such delivery or refund is sole and exclusive remedies to your company for the defective product.
 - 8-3. **Remedies after Quality Warranty Period**

With respect to any defect of this product found after the quality warranty period, the defect will be analyzed by us. On the basis of the defect analysis results, the scope and amounts of damage shall be determined by mutual agreement of both parties. Then we will deal with upper limit in Section 8-2. This provision is not intended to limit any legal rights of your company.
9. Anti-radiation design is not implemented in the products described in this document.
10. The X-ray exposure can influence functions and characteristics of the products. Confirm the product functions and characteristics in the evaluation stage.
11. WLCSP products should be used in light shielded environments. The light exposure can influence functions and characteristics of the products under operation or storage.
12. Warning for handling Gallium and Arsenic (GaAs) products (Applying to GaAs MMIC, Photo Reflector). These products use Gallium (Ga) and Arsenic (As) which are specified as poisonous chemicals by law. For the prevention of a hazard, do not burn, destroy, or process chemically to make them as gas or power. When the product is disposed of, please follow the related regulation and do not mix this with general industrial waste or household waste.
13. Please contact our sales representatives should you have any questions or comments concerning the products or the technical information.



Nisshinbo Micro Devices Inc.

Official website

<https://www.nisshinbo-microdevices.co.jp/en/>

Purchase information

<https://www.nisshinbo-microdevices.co.jp/en/buy/>