

To our customers,

---

## Old Company Name in Catalogs and Other Documents

---

On April 1<sup>st</sup>, 2010, NEC Electronics Corporation merged with Renesas Technology Corporation, and Renesas Electronics Corporation took over all the business of both companies. Therefore, although the old company name remains in this document, it is a valid Renesas Electronics document. We appreciate your understanding.

Renesas Electronics website: <http://www.renesas.com>

April 1<sup>st</sup>, 2010  
Renesas Electronics Corporation

Issued by: Renesas Electronics Corporation (<http://www.renesas.com>)

Send any inquiries to <http://www.renesas.com/inquiry>.

## Notice

1. All information included in this document is current as of the date this document is issued. Such information, however, is subject to change without any prior notice. Before purchasing or using any Renesas Electronics products listed herein, please confirm the latest product information with a Renesas Electronics sales office. Also, please pay regular and careful attention to additional and different information to be disclosed by Renesas Electronics such as that disclosed through our website.
2. Renesas Electronics does not assume any liability for infringement of patents, copyrights, or other intellectual property rights of third parties by or arising from the use of Renesas Electronics products or technical information described in this document. No license, express, implied or otherwise, is granted hereby under any patents, copyrights or other intellectual property rights of Renesas Electronics or others.
3. You should not alter, modify, copy, or otherwise misappropriate any Renesas Electronics product, whether in whole or in part.
4. Descriptions of circuits, software and other related information in this document are provided only to illustrate the operation of semiconductor products and application examples. You are fully responsible for the incorporation of these circuits, software, and information in the design of your equipment. Renesas Electronics assumes no responsibility for any losses incurred by you or third parties arising from the use of these circuits, software, or information.
5. When exporting the products or technology described in this document, you should comply with the applicable export control laws and regulations and follow the procedures required by such laws and regulations. You should not use Renesas Electronics products or the technology described in this document for any purpose relating to military applications or use by the military, including but not limited to the development of weapons of mass destruction. Renesas Electronics products and technology may not be used for or incorporated into any products or systems whose manufacture, use, or sale is prohibited under any applicable domestic or foreign laws or regulations.
6. Renesas Electronics has used reasonable care in preparing the information included in this document, but Renesas Electronics does not warrant that such information is error free. Renesas Electronics assumes no liability whatsoever for any damages incurred by you resulting from errors in or omissions from the information included herein.
7. Renesas Electronics products are classified according to the following three quality grades: “Standard”, “High Quality”, and “Specific”. The recommended applications for each Renesas Electronics product depends on the product’s quality grade, as indicated below. You must check the quality grade of each Renesas Electronics product before using it in a particular application. You may not use any Renesas Electronics product for any application categorized as “Specific” without the prior written consent of Renesas Electronics. Further, you may not use any Renesas Electronics product for any application for which it is not intended without the prior written consent of Renesas Electronics. Renesas Electronics shall not be in any way liable for any damages or losses incurred by you or third parties arising from the use of any Renesas Electronics product for an application categorized as “Specific” or for which the product is not intended where you have failed to obtain the prior written consent of Renesas Electronics. The quality grade of each Renesas Electronics product is “Standard” unless otherwise expressly specified in a Renesas Electronics data sheets or data books, etc.
  - “Standard”: Computers; office equipment; communications equipment; test and measurement equipment; audio and visual equipment; home electronic appliances; machine tools; personal electronic equipment; and industrial robots.
  - “High Quality”: Transportation equipment (automobiles, trains, ships, etc.); traffic control systems; anti-disaster systems; anti-crime systems; safety equipment; and medical equipment not specifically designed for life support.
  - “Specific”: Aircraft; aerospace equipment; submersible repeaters; nuclear reactor control systems; medical equipment or systems for life support (e.g. artificial life support devices or systems), surgical implantations, or healthcare intervention (e.g. excision, etc.), and any other applications or purposes that pose a direct threat to human life.
8. You should use the Renesas Electronics products described in this document within the range specified by Renesas Electronics, especially with respect to the maximum rating, operating supply voltage range, movement power voltage range, heat radiation characteristics, installation and other product characteristics. Renesas Electronics shall have no liability for malfunctions or damages arising out of the use of Renesas Electronics products beyond such specified ranges.
9. Although Renesas Electronics endeavors to improve the quality and reliability of its products, semiconductor products have specific characteristics such as the occurrence of failure at a certain rate and malfunctions under certain use conditions. Further, Renesas Electronics products are not subject to radiation resistance design. Please be sure to implement safety measures to guard them against the possibility of physical injury, and injury or damage caused by fire in the event of the failure of a Renesas Electronics product, such as safety design for hardware and software including but not limited to redundancy, fire control and malfunction prevention, appropriate treatment for aging degradation or any other appropriate measures. Because the evaluation of microcomputer software alone is very difficult, please evaluate the safety of the final products or system manufactured by you.
10. Please contact a Renesas Electronics sales office for details as to environmental matters such as the environmental compatibility of each Renesas Electronics product. Please use Renesas Electronics products in compliance with all applicable laws and regulations that regulate the inclusion or use of controlled substances, including without limitation, the EU RoHS Directive. Renesas Electronics assumes no liability for damages or losses occurring as a result of your noncompliance with applicable laws and regulations.
11. This document may not be reproduced or duplicated, in any form, in whole or in part, without prior written consent of Renesas Electronics.
12. Please contact a Renesas Electronics sales office if you have any questions regarding the information contained in this document or Renesas Electronics products, or if you have any other inquiries.

(Note 1) “Renesas Electronics” as used in this document means Renesas Electronics Corporation and also includes its majority-owned subsidiaries.

(Note 2) “Renesas Electronics product(s)” means any product developed or manufactured by or for Renesas Electronics.

# BIPOLAR ANALOG INTEGRATED CIRCUIT

## $\mu$ PC24M00A Series

### THREE TERMINAL LOW DROPOUT VOLTAGE REGULATOR

#### DESCRIPTION

$\mu$ PC24M00A Series are low dropout regulators which have 500 mA capable for output current. These ICs are built-in the saturation protection circuit of the output transistor.

#### FEATURES

- Built-in the saturaiton protection circuit of the output transistor.
- The capability of output current is 500 mA.
- High accuracy of output voltage.
  - $|\Delta V_o| \leq \pm 2\%$  ( $T_J = 25\text{ }^\circ\text{C}$ )
  - $|\Delta V_o| \leq \pm 3\%$  ( $0\text{ }^\circ\text{C} \leq T_J \leq 125\text{ }^\circ\text{C}$ )
- Low dropout voltage.
  - $V_{DIF} \leq 1\text{ V}$  ( $I_o \leq 500\text{ mA}$ ,  $T_J \leq 125\text{ }^\circ\text{C}$ )
- Built-in overcurrent protection circuit, thermal shut-down circuit.
- Built-in Safe Operating Area protection circuit.
- Compatible for  $\mu$ PC24M00 Series.

#### CONNECTION DIAGRAM (TOP VIEW)

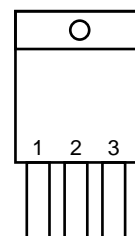

1 : INPUT  
2 : GND  
3 : OUTPUT

#### ORDERING INFORMATION

Output Voltage	Type Number	Package
5 V	$\mu$ PC24M05AHF	MP-45G (Isolated TO-220)
6 V	$\mu$ PC24M06AHF	
7 V	$\mu$ PC24M07AHF	
8 V	$\mu$ PC24M08AHF	
9 V	$\mu$ PC24M09AHF	
10 V	$\mu$ PC24M10AHF	
12 V	$\mu$ PC24M12AHF	
15 V	$\mu$ PC24M15AHF	
18 V	$\mu$ PC24M18AHF	

BLOCK DIAGRAM

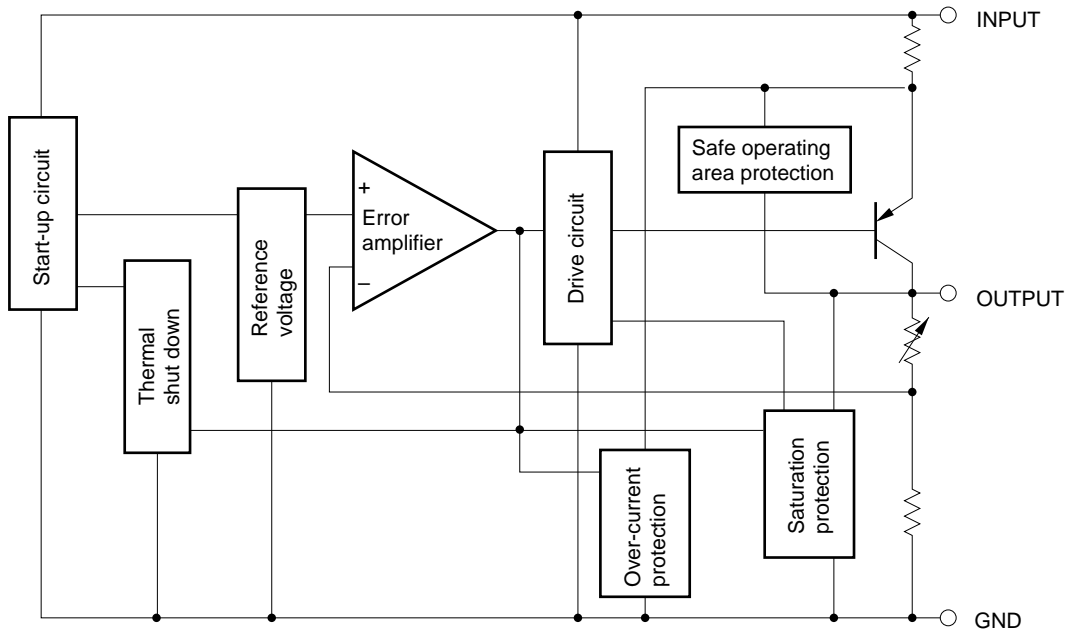

**ABSOLUTE MAXIMUM RATINGS (T<sub>A</sub> = 25 °C, Unless otherwise specified.)**

PARAMETER	SYMBOL	RATING	UNIT
Input Voltage	V <sub>IN</sub>	36	V
Internal Power Dissipation	P <sub>T</sub>	15 <b>Note</b>	W
Operating Ambient Temperature Range	T <sub>A</sub>	-20 to +85	°C
Operating Junction Temperature Range	T <sub>J</sub>	-20 to +150	°C
Storage Temperature Range	T <sub>stg</sub>	-55 to +150	°C
Thermal Resistance (Junction to Case)	R <sub>th(J - C)</sub>	7.0	°C/W
Thermal Resistance (Junction to Ambient)	R <sub>th(J - A)</sub>	65	°C/W

**Note** Internally limited.

**TYPICAL CONNECTION**

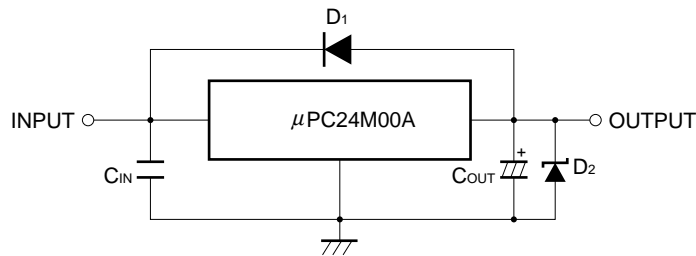

- C<sub>IN</sub> : 0.1 to 0.47 μF.
- C<sub>OUT</sub> : More than 47 μF.
- D<sub>1</sub> : Need for V<sub>O</sub> > V<sub>IN</sub>.
- D<sub>2</sub> : Need for V<sub>O</sub> < GND.

**RECOMMENDED OPERATING CONDITIONS**

PARAMETER	SYMBOL	TYPE NUMBER	MIN.	TYP.	MAX.	UNIT
Input Voltage	V <sub>IN</sub>	μPC24M05AHF	6	9	20	V
		μPC24M06AHF	7	10	21	
		μPC24M07AHF	8	11	22	
		μPC24M08AHF	9	13	23	
		μPC24M09AHF	10	14	24	
		μPC24M10AHF	11	15	25	
		μPC24M12AHF	13	18	27	
		μPC24M15AHF	16	22	27	
μPC24M18AHF	19	25	28			
Output Current	I <sub>O</sub>	All	0		500	mA
Operating Ambient Temperature Range	T <sub>A</sub>	All	-20		+85	°C
Operating Junction Temperature Range	T <sub>J</sub>	All	-20		+125	°C

**ELECTRICAL CHARACTERISTICS**

**μPC24M05A (V<sub>IN</sub> = 9 V, I<sub>o</sub> = 350 mA, T<sub>J</sub> = 25 °C, Unless otherwise specified)**

PARAMETER	SYMBOL	MIN.	TYP.	MAX.	UNIT	TEST CONDITIONS
Output Voltage	V <sub>o</sub>	4.9	5.0	5.1	V	
		4.85		5.15		6 V ≤ V <sub>IN</sub> ≤ 20 V, 5 mA ≤ I <sub>o</sub> ≤ 350 mA, 0 °C ≤ T <sub>J</sub> ≤ 125 °C
		4.85		5.15		5 mA ≤ I <sub>o</sub> ≤ 500 mA, 0 °C ≤ T <sub>J</sub> ≤ 125 °C
Line Regulation	REG <sub>IN</sub>		5	50	mV	6.5 V ≤ V <sub>IN</sub> ≤ 20 V
Load Regulation	REG <sub>L</sub>		3	25	mV	5 mA ≤ I <sub>o</sub> ≤ 500 mA
Quiescent Current	I <sub>BIAS</sub>		2.3	3.2	mA	I <sub>o</sub> = 0
			7	30		I <sub>o</sub> = 500 mA
Start-up Current	I <sub>BIAS(S)</sub>			15	mA	V <sub>IN</sub> = 4.5 V, I <sub>o</sub> = 0 mA
				45		V <sub>IN</sub> = 4.5 V, I <sub>o</sub> = 500 mA
Quiescent Current Change	ΔI <sub>BIAS</sub>			10	mA	6.5 V ≤ V <sub>IN</sub> ≤ 20 V, I <sub>o</sub> = 500 mA
Output Noise Voltage	V <sub>n</sub>		90		μV <sub>rms</sub>	10 Hz ≤ f ≤ 100 kHz
Ripple Rejection	R·R	55	60		dB	f = 120 Hz, 6.5 V ≤ V <sub>IN</sub> ≤ 16.5 V
Dropout Voltage	V <sub>DIF</sub>		0.5	1.0	V	I <sub>o</sub> = 500 mA, 0 °C ≤ T <sub>J</sub> ≤ 125 °C
Short Circuit Current	I <sub>short</sub>		0.6		A	V <sub>IN</sub> = 20 V
Peak Output Current	I <sub>opeak</sub>	0.75	1.0	1.63	A	V <sub>IN</sub> = 9 V
Temperature Coefficient of Output Voltage	ΔV <sub>o</sub> /ΔT		0.2		mV/°C	I <sub>o</sub> = 5 mA, 0 °C ≤ T <sub>J</sub> ≤ 125 °C

**μPC24M06A (V<sub>IN</sub> = 10 V, I<sub>o</sub> = 350 mA, T<sub>J</sub> = 25 °C, Unless otherwise specified)**

PARAMETER	SYMBOL	MIN.	TYP.	MAX.	UNIT	TEST CONDITIONS
Output Voltage	V <sub>o</sub>	5.88	6.0	6.12	V	
		5.82		6.18		7 V ≤ V <sub>IN</sub> ≤ 21 V, 5 mA ≤ I <sub>o</sub> ≤ 350 mA, 0 °C ≤ T <sub>J</sub> ≤ 125 °C
		5.82		6.18		5 mA ≤ I <sub>o</sub> ≤ 500 mA, 0 °C ≤ T <sub>J</sub> ≤ 125 °C
Line Regulation	REG <sub>IN</sub>		6	60	mV	7.5 V ≤ V <sub>IN</sub> ≤ 21 V
Load Regulation	REG <sub>L</sub>		4	30	mV	5 mA ≤ I <sub>o</sub> ≤ 500 mA
Quiescent Current	I <sub>BIAS</sub>		2.3	3.2	mA	I <sub>o</sub> = 0
			7	30		I <sub>o</sub> = 500 mA
Start-up Current	I <sub>BIAS(S)</sub>			15	mA	V <sub>IN</sub> = 5.5 V, I <sub>o</sub> = 0 mA
				45		V <sub>IN</sub> = 5.5 V, I <sub>o</sub> = 500 mA
Quiescent Current Change	ΔI <sub>BIAS</sub>			10	mA	7.5 V ≤ V <sub>IN</sub> ≤ 21 V, I <sub>o</sub> = 500 mA
Output Noise Voltage	V <sub>n</sub>		110		μV <sub>rms</sub>	10 Hz ≤ f ≤ 100 kHz
Ripple Rejection	R·R	53	58		dB	f = 120 Hz, 7.5 V ≤ V <sub>IN</sub> ≤ 17.5 V
Dropout Voltage	V <sub>DIF</sub>		0.5	1.0	V	I <sub>o</sub> = 500 mA, 0 °C ≤ T <sub>J</sub> ≤ 125 °C
Short Circuit Current	I <sub>short</sub>		0.6		A	V <sub>IN</sub> = 21 V
Peak Output Current	I <sub>opeak</sub>	0.75	1.0	1.63	A	V <sub>IN</sub> = 10 V
Temperature Coefficient of Output Voltage	ΔV <sub>o</sub> /ΔT		-0.4		mV/°C	I <sub>o</sub> = 5 mA, 0 °C ≤ T <sub>J</sub> ≤ 125 °C

μPC24M07A (V<sub>IN</sub> = 11 V, I<sub>o</sub> = 350 mA, T<sub>J</sub> = 25 °C, Unless otherwise specified)

PARAMETER	SYMBOL	MIN.	TYP.	MAX.	UNIT	TEST CONDITIONS
Output Voltage	V <sub>O</sub>	6.86	7.0	7.14	V	
		6.79		7.21		8 V ≤ V <sub>IN</sub> ≤ 22 V, 5 mA ≤ I <sub>o</sub> ≤ 350 mA, 0 °C ≤ T <sub>J</sub> ≤ 125 °C
		6.79		7.21		5 mA ≤ I <sub>o</sub> ≤ 500 mA, 0 °C ≤ T <sub>J</sub> ≤ 125 °C
Line Regulation	REG <sub>IN</sub>		7	70	mV	8.5 V ≤ V <sub>IN</sub> ≤ 22 V
Load Regulation	REG <sub>L</sub>		4	35	mV	5 mA ≤ I <sub>o</sub> ≤ 500 mA
Quiescent Current	I <sub>BIAS</sub>		2.3	3.2	mA	I <sub>o</sub> = 0
			7	30		I <sub>o</sub> = 500 mA
Start-up Current	I <sub>BIAS(S)</sub>			15	mA	V <sub>IN</sub> = 6.5 V, I <sub>o</sub> = 0 mA
				45		V <sub>IN</sub> = 6.5 V, I <sub>o</sub> = 500 mA
Quiescent Current Change	ΔI <sub>BIAS</sub>			10	mA	8.5 V ≤ V <sub>IN</sub> ≤ 22 V, I <sub>o</sub> = 500 mA
Output Noise Voltage	V <sub>n</sub>		130		μV <sub>rms</sub>	10 Hz ≤ f ≤ 100 kHz
Ripple Rejection	R·R	52	57		dB	f = 120 Hz, 8.5 V ≤ V <sub>IN</sub> ≤ 18.5 V
Dropout Voltage	V <sub>DIF</sub>		0.5	1.0	V	I <sub>o</sub> = 500 mA, 0 °C ≤ T <sub>J</sub> ≤ 125 °C
Short Circuit Current	I <sub>short</sub>		0.6		A	V <sub>IN</sub> = 22 V
Peak Output Current	I <sub>opeak</sub>	0.75	1.0	1.63	A	V <sub>IN</sub> = 11 V
Temperature Coefficient of Output Voltage	ΔV <sub>O</sub> /ΔT		0.4		mV/°C	I <sub>o</sub> = 5 mA, 0 °C ≤ T <sub>J</sub> ≤ 125 °C

μPC24M08A (V<sub>IN</sub> = 13 V, I<sub>o</sub> = 350 mA, T<sub>J</sub> = 25 °C, Unless otherwise specified)

PARAMETER	SYMBOL	MIN.	TYP.	MAX.	UNIT	TEST CONDITIONS
Output Voltage	V <sub>O</sub>	7.85	8.0	8.15	V	
		7.75		8.25		9 V ≤ V <sub>IN</sub> ≤ 23 V, 5 mA ≤ I <sub>o</sub> ≤ 350 mA, 0 °C ≤ T <sub>J</sub> ≤ 125 °C
		7.75		8.25		5 mA ≤ I <sub>o</sub> ≤ 500 mA, 0 °C ≤ T <sub>J</sub> ≤ 125 °C
Line Regulation	REG <sub>IN</sub>		8	80	mV	9.5 V ≤ V <sub>IN</sub> ≤ 23 V
Load Regulation	REG <sub>L</sub>		5	40	mV	5 mA ≤ I <sub>o</sub> ≤ 500 mA
Quiescent Current	I <sub>BIAS</sub>		2.3	3.2	mA	I <sub>o</sub> = 0
			7	30		I <sub>o</sub> = 500 mA
Start-up Current	I <sub>BIAS(S)</sub>			15	mA	V <sub>IN</sub> = 7.5 V, I <sub>o</sub> = 0 mA
				45		V <sub>IN</sub> = 7.5 V, I <sub>o</sub> = 500 mA
Quiescent Current Change	ΔI <sub>BIAS</sub>			10	mA	9.5 V ≤ V <sub>IN</sub> ≤ 23 V, I <sub>o</sub> = 500 mA
Output Noise Voltage	V <sub>n</sub>		150		μV <sub>rms</sub>	10 Hz ≤ f ≤ 100 kHz
Ripple Rejection	R·R	51	56		dB	f = 120 Hz, 9.5 V ≤ V <sub>IN</sub> ≤ 19.5 V
Dropout Voltage	V <sub>DIF</sub>		0.5	1.0	V	I <sub>o</sub> = 500 mA, 0 °C ≤ T <sub>J</sub> ≤ 125 °C
Short Circuit Current	I <sub>short</sub>		0.5		A	V <sub>IN</sub> = 23 V
Peak Output Current	I <sub>opeak</sub>	0.74	1.0	1.62	A	V <sub>IN</sub> = 13 V
Temperature Coefficient of Output Voltage	ΔV <sub>O</sub> /ΔT		0.8		mV/°C	I <sub>o</sub> = 5 mA, 0 °C ≤ T <sub>J</sub> ≤ 125 °C

μPC24M09A (V<sub>IN</sub> = 14 V, I<sub>o</sub> = 350 mA, T<sub>J</sub> = 25 °C, Unless otherwise specified)

PARAMETER	SYMBOL	MIN.	TYP.	MAX.	UNIT	TEST CONDITIONS
Output Voltage	V <sub>O</sub>	8.82	9.0	9.18	V	
		8.73		9.27		10 V ≤ V <sub>IN</sub> ≤ 24 V, 5 mA ≤ I <sub>o</sub> ≤ 350 mA, 0 °C ≤ T <sub>J</sub> ≤ 125 °C
		8.73		9.27		5 mA ≤ I <sub>o</sub> ≤ 500 mA, 0 °C ≤ T <sub>J</sub> ≤ 125 °C
Line Regulation	REG <sub>IN</sub>		9	90	mV	10.5 V ≤ V <sub>IN</sub> ≤ 24 V
Load Regulation	REG <sub>L</sub>		5	45	mV	5 mA ≤ I <sub>o</sub> ≤ 500 mA
Quiescent Current	I <sub>BIAS</sub>		2.4	3.2	mA	I <sub>o</sub> = 0
			7	30		I <sub>o</sub> = 500 mA
Start-up Current	I <sub>BIAS(S)</sub>			15	mA	V <sub>IN</sub> = 8.5 V, I <sub>o</sub> = 0 mA
				45		V <sub>IN</sub> = 8.5 V, I <sub>o</sub> = 500 mA
Quiescent Current Change	ΔI <sub>BIAS</sub>			10	mA	10.5 V ≤ V <sub>IN</sub> ≤ 24 V, I <sub>o</sub> = 500 mA
Output Noise Voltage	V <sub>n</sub>		170		μV <sub>rms</sub>	10 Hz ≤ f ≤ 100 kHz
Ripple Rejection	R·R	50	55		dB	f = 120 Hz, 10.5 V ≤ V <sub>IN</sub> ≤ 20.5 V
Dropout Voltage	V <sub>DIF</sub>		0.5	1.0	V	I <sub>o</sub> = 500 mA, 0 °C ≤ T <sub>J</sub> ≤ 125 °C
Short Circuit Current	I <sub>Oshort</sub>		0.5		A	V <sub>IN</sub> = 24 V
Peak Output Current	I <sub>Opeak</sub>	0.74	1.0	1.62	A	V <sub>IN</sub> = 14 V
Temperature Coefficient of Output Voltage	ΔV <sub>O</sub> /ΔT		1.0		mV/°C	I <sub>o</sub> = 5 mA, 0 °C ≤ T <sub>J</sub> ≤ 125 °C

μPC24M10A (V<sub>IN</sub> = 15 V, I<sub>o</sub> = 350 mA, T<sub>J</sub> = 25 °C, Unless otherwise specified)

PARAMETER	SYMBOL	MIN.	TYP.	MAX.	UNIT	TEST CONDITIONS
Output Voltage	V <sub>O</sub>	9.8	10	10.2	V	
		9.7		10.3		11 V ≤ V <sub>IN</sub> ≤ 25 V, 5 mA ≤ I <sub>o</sub> ≤ 350 mA, 0 °C ≤ T <sub>J</sub> ≤ 125 °C
		9.7		10.3		5 mA ≤ I <sub>o</sub> ≤ 500 mA, 0 °C ≤ T <sub>J</sub> ≤ 125 °C
Line Regulation	REG <sub>IN</sub>		10	100	mV	11.5 V ≤ V <sub>IN</sub> ≤ 25 V
Load Regulation	REG <sub>L</sub>		6	50	mV	5 mA ≤ I <sub>o</sub> ≤ 500 mA
Quiescent Current	I <sub>BIAS</sub>		2.4	3.2	mA	I <sub>o</sub> = 0
			7	30		I <sub>o</sub> = 500 mA
Start-up Current	I <sub>BIAS(S)</sub>			15	mA	V <sub>IN</sub> = 9.5 V, I <sub>o</sub> = 0 mA
				45		V <sub>IN</sub> = 9.5 V, I <sub>o</sub> = 500 mA
Quiescent Current Change	ΔI <sub>BIAS</sub>			10	mA	11.5 V ≤ V <sub>IN</sub> ≤ 25 V, I <sub>o</sub> = 500 mA
Output Noise Voltage	V <sub>n</sub>		190		μV <sub>rms</sub>	10 Hz ≤ f ≤ 100 kHz
Ripple Rejection	R·R	49	54		dB	f = 120 Hz, 11.5 V ≤ V <sub>IN</sub> ≤ 21.5 V
Dropout Voltage	V <sub>DIF</sub>		0.5	1.0	V	I <sub>o</sub> = 500 mA, 0 °C ≤ T <sub>J</sub> ≤ 125 °C
Short Circuit Current	I <sub>Oshort</sub>		0.4		A	V <sub>IN</sub> = 25 V
Peak Output Current	I <sub>Opeak</sub>	0.74	1.0	1.62	A	V <sub>IN</sub> = 15 V
Temperature Coefficient of Output Voltage	ΔV <sub>O</sub> /ΔT		1.6		mV/°C	I <sub>o</sub> = 5 mA, 0 °C ≤ T <sub>J</sub> ≤ 125 °C



$\mu$ PC24M12A ( $V_{IN} = 18\text{ V}$ ,  $I_o = 350\text{ mA}$ ,  $T_J = 25\text{ }^\circ\text{C}$ , Unless otherwise specified)

PARAMETER	SYMBOL	MIN.	TYP.	MAX.	UNIT	TEST CONDITIONS
Output Voltage	$V_o$	11.75	12	12.25	V	
		11.65		12.35		$13\text{ V} \leq V_{IN} \leq 27\text{ V}$ , $5\text{ mA} \leq I_o \leq 350\text{ mA}$ , $0\text{ }^\circ\text{C} \leq T_J \leq 125\text{ }^\circ\text{C}$
		11.65		12.35		$5\text{ mA} \leq I_o \leq 500\text{ mA}$ , $0\text{ }^\circ\text{C} \leq T_J \leq 125\text{ }^\circ\text{C}$
Line Regulation	$REG_{IN}$		12	120	mV	$14\text{ V} \leq V_{IN} \leq 27\text{ V}$
Load Regulation	$REG_L$		7	60	mV	$5\text{ mA} \leq I_o \leq 500\text{ mA}$
Quiescent Current	$I_{BIAS}$		2.4	3.2	mA	$I_o = 0$
			8	30		$I_o = 500\text{ mA}$
Start-up Current	$I_{BIAS(S)}$			15	mA	$V_{IN} = 11.5\text{ V}$ , $I_o = 0\text{ mA}$
				45		$V_{IN} = 11.5\text{ V}$ , $I_o = 500\text{ mA}$
Quiescent Current Change	$\Delta I_{BIAS}$			10	mA	$14\text{ V} \leq V_{IN} \leq 27\text{ V}$ , $I_o = 500\text{ mA}$
Output Noise Voltage	$V_n$		230		$\mu\text{V}_{rms}$	$10\text{ Hz} \leq f \leq 100\text{ kHz}$
Ripple Rejection	R·R	47	52		dB	$f = 120\text{ Hz}$ , $14\text{ V} \leq V_{IN} \leq 24\text{ V}$
Dropout Voltage	$V_{DIF}$		0.5	1.0	V	$I_o = 500\text{ mA}$ , $0\text{ }^\circ\text{C} \leq T_J \leq 125\text{ }^\circ\text{C}$
Short Circuit Current	$I_{short}$		0.4		A	$V_{IN} = 27\text{ V}$
Peak Output Current	$I_{peak}$	0.73	1.0	1.61	A	$V_{IN} = 18\text{ V}$
Temperature Coefficient of Output Voltage	$\Delta V_o/\Delta T$		0.7		$\text{mV}/^\circ\text{C}$	$I_o = 5\text{ mA}$ , $0\text{ }^\circ\text{C} \leq T_J \leq 125\text{ }^\circ\text{C}$

$\mu$ PC24M15A ( $V_{IN} = 22\text{ V}$ ,  $I_o = 350\text{ mA}$ ,  $T_J = 25\text{ }^\circ\text{C}$ , Unless otherwise specified)

PARAMETER	SYMBOL	MIN.	TYP.	MAX.	UNIT	TEST CONDITIONS
Output Voltage	$V_o$	14.7	15	15.3	V	
		14.55		15.45		$16\text{ V} \leq V_{IN} \leq 27\text{ V}$ , $5\text{ mA} \leq I_o \leq 350\text{ mA}$ , $0\text{ }^\circ\text{C} \leq T_J \leq 125\text{ }^\circ\text{C}$
		14.55		15.45		$5\text{ mA} \leq I_o \leq 500\text{ mA}$ , $0\text{ }^\circ\text{C} \leq T_J \leq 125\text{ }^\circ\text{C}$
Line Regulation	$REG_{IN}$		15	150	mV	$17\text{ V} \leq V_{IN} \leq 27\text{ V}$
Load Regulation	$REG_L$		9	75	mV	$5\text{ mA} \leq I_o \leq 500\text{ mA}$
Quiescent Current	$I_{BIAS}$		2.5	3.2	mA	$I_o = 0$
			8	30		$I_o = 500\text{ mA}$
Start-up Current	$I_{BIAS(S)}$			15	mA	$V_{IN} = 14.5\text{ V}$ , $I_o = 0\text{ mA}$
				45		$V_{IN} = 14.5\text{ V}$ , $I_o = 500\text{ mA}$
Quiescent Current Change	$\Delta I_{BIAS}$			10	mA	$17\text{ V} \leq V_{IN} \leq 27\text{ V}$ , $I_o = 500\text{ mA}$
Output Noise Voltage	$V_n$		290		$\mu\text{V}_{rms}$	$10\text{ Hz} \leq f \leq 100\text{ kHz}$
Ripple Rejection	R·R	46	51		dB	$f = 120\text{ Hz}$ , $17\text{ V} \leq V_{IN} \leq 27\text{ V}$
Dropout Voltage	$V_{DIF}$		0.5	1.0	V	$I_o = 500\text{ mA}$ , $0\text{ }^\circ\text{C} \leq T_J \leq 125\text{ }^\circ\text{C}$
Short Circuit Current	$I_{short}$		0.4		A	$V_{IN} = 27\text{ V}$
Peak Output Current	$I_{peak}$	0.72	1.0	1.6	A	$V_{IN} = 22\text{ V}$
Temperature Coefficient of Output Voltage	$\Delta V_o/\Delta T$		1.6		$\text{mV}/^\circ\text{C}$	$I_o = 5\text{ mA}$ , $0\text{ }^\circ\text{C} \leq T_J \leq 125\text{ }^\circ\text{C}$

μPC24M18A ( $V_{IN} = 25\text{ V}$ ,  $I_o = 350\text{ mA}$ ,  $T_J = 25\text{ °C}$ , Unless otherwise specified)

PARAMETER	SYMBOL	MIN.	TYP.	MAX.	UNIT	TEST CONDITIONS
Output Voltage	$V_o$	17.64	18	18.36	V	
		17.46		18.54		$19\text{ V} \leq V_{IN} \leq 28\text{ V}$ , $5\text{ mA} \leq I_o \leq 350\text{ mA}$ , $0\text{ °C} \leq T_J \leq 125\text{ °C}$
		17.46		18.54		$5\text{ mA} \leq I_o \leq 500\text{ mA}$ , $0\text{ °C} \leq T_J \leq 125\text{ °C}$
Line Regulation	$REG_{IN}$		18	180	mV	$20\text{ V} \leq V_{IN} \leq 28\text{ V}$
Load Regulation	$REG_L$		11	90	mV	$5\text{ mA} \leq I_o \leq 500\text{ mA}$
Quiescent Current	$I_{BIAS}$		2.5	3.2	mA	$I_o = 0$
			8	30		$I_o = 500\text{ mA}$
Start-up Current	$I_{BIAS(S)}$			15	mA	$V_{IN} = 17.5\text{ V}$ , $I_o = 0\text{ mA}$
				45		$V_{IN} = 17.5\text{ V}$ , $I_o = 500\text{ mA}$
Quiescent Current Change	$\Delta I_{BIAS}$			10	mA	$20\text{ V} \leq V_{IN} \leq 28\text{ V}$ , $I_o = 500\text{ mA}$
Output Noise Voltage	$V_n$		350		$\mu V_{rms}$	$10\text{ Hz} \leq f \leq 100\text{ kHz}$
Ripple Rejection	R·R	44	49		dB	$f = 120\text{ Hz}$ , $20\text{ V} \leq V_{IN} \leq 28\text{ V}$
Dropout Voltage	$V_{DIF}$		0.5	1.0	V	$I_o = 500\text{ mA}$ , $0\text{ °C} \leq T_J \leq 125\text{ °C}$
Short Circuit Current	$I_{Oshort}$		0.4		A	$V_{IN} = 28\text{ V}$
Peak Output Current	$I_{Opeak}$	0.72	1.0	1.6	A	$V_{IN} = 25\text{ V}$
Temperature Coefficient of Output Voltage	$\Delta V_o/\Delta T$		2.2		mV/°C	$I_o = 5\text{ mA}$ , $0\text{ °C} \leq T_J \leq 125\text{ °C}$

TYPICAL CHARACTERISTICS

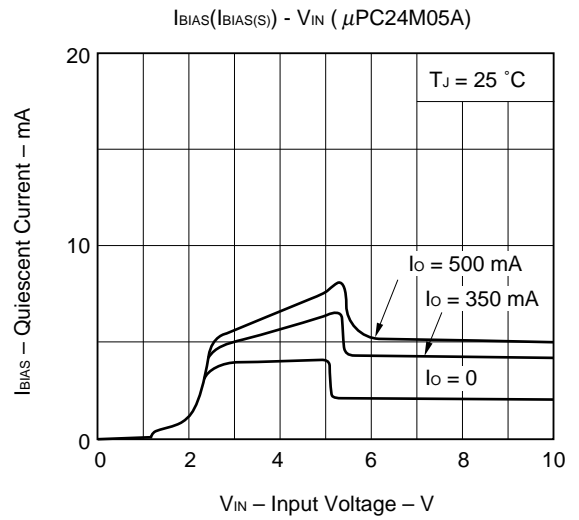
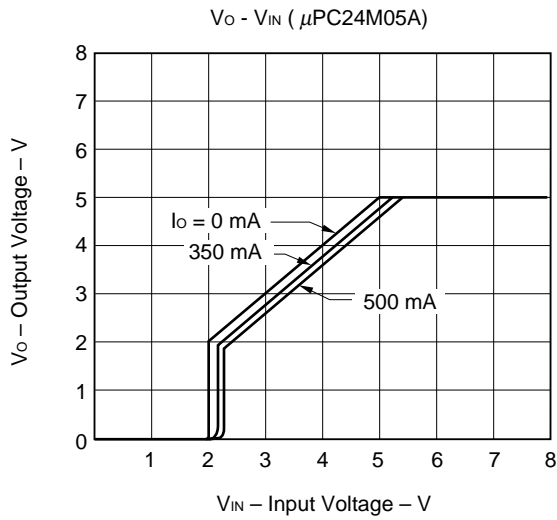
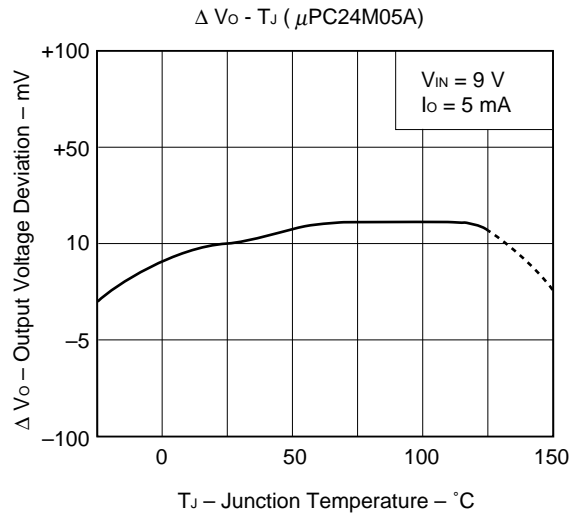
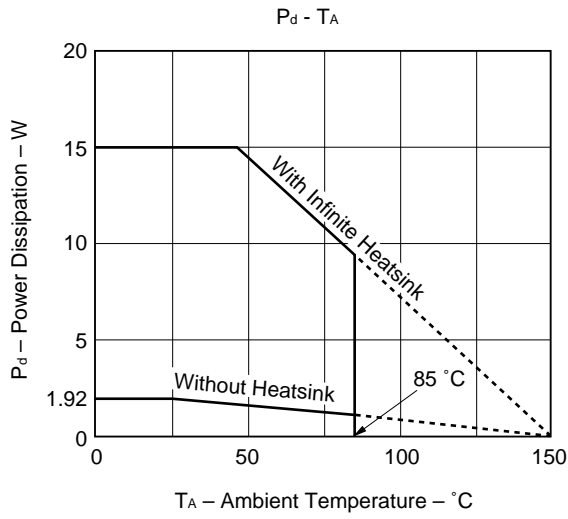

TYPICAL CHARACTERISTICS

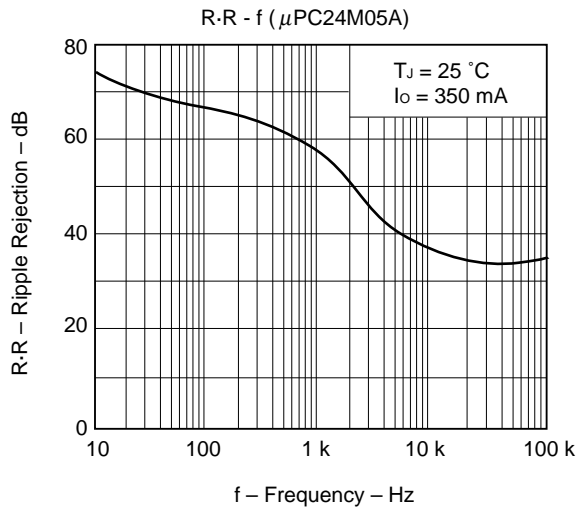
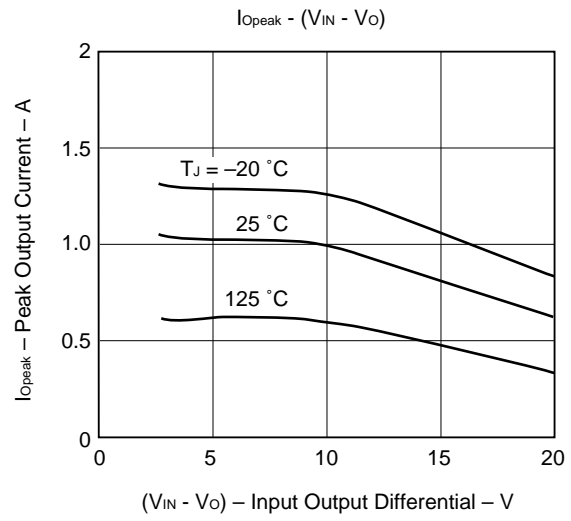
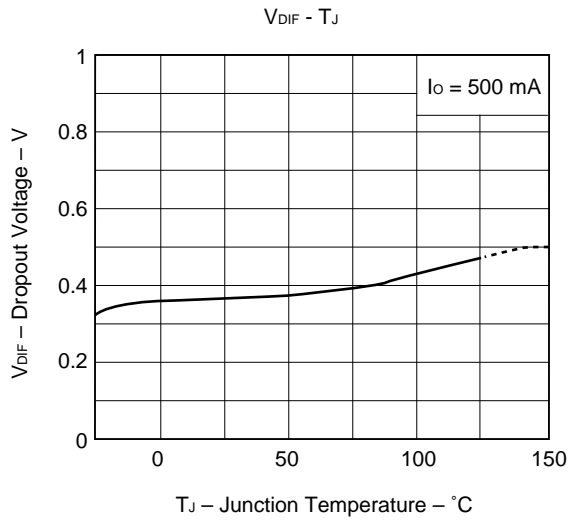

PACKAGE DIMENSIONS (Unit: mm)

μPC24M00AHF Series

3PIN PLASTIC SIP (MP-45G)

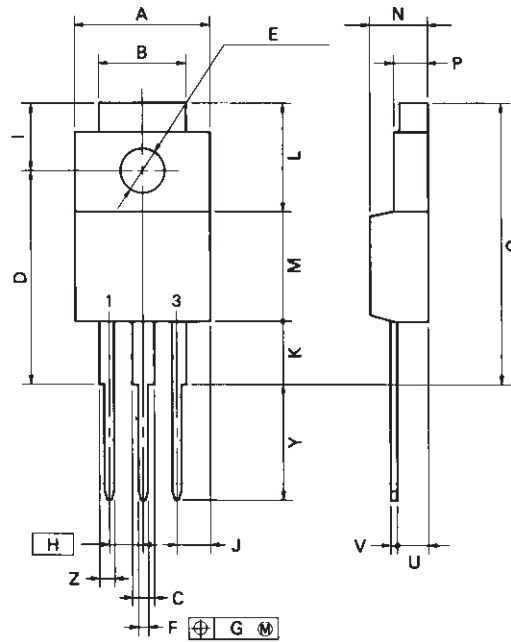

P3HF-254B-1

**NOTE**

Each lead centerline is located within 0.25 mm (0.01 inch) of its true position (T.P.) at maximum material condition.

ITEM	MILLIMETERS	INCHES
A	10.4 MAX.	0.410 MAX.
B	7.0	0.276
C	1.2 MIN.	0.047 MIN.
D	17.0 <sup>±0.3</sup>	0.669 <sup>+0.013</sup> <sub>-0.012</sub>
E	φ3.3 <sup>±0.2</sup>	φ0.130 <sup>+0.008</sup>
F	0.75 <sup>±0.10</sup>	0.030 <sup>+0.004</sup> <sub>-0.006</sub>
G	0.25	0.010
H	2.54 (T.P.)	0.100 (T.P.)
I	5.0 <sup>±0.3</sup>	0.197 <sup>±0.012</sup>
J	2.66 MAX.	0.105 MAX.
K	4.8 MIN.	0.188 MIN.
L	8.5	0.335
M	8.5	0.335
N	4.5 <sup>±0.2</sup>	0.177 <sup>±0.008</sup>
P	2.8 <sup>±0.2</sup>	0.110 <sup>+0.003</sup> <sub>-0.006</sub>
Q	22.4 MAX.	0.882 MAX.
U	2.4 <sup>±0.5</sup>	0.094 <sup>+0.021</sup> <sub>-0.020</sub>
V	0.65 <sup>±0.10</sup>	0.026 <sup>+0.004</sup> <sub>-0.006</sub>
Y	8.9 <sup>±0.7</sup>	0.350 <sup>±0.028</sup>
Z	1.0 MIN.	0.039 MIN.

**RECOMMENDED SOLDERING CONDITIONS**

The following conditions (see table below) must be met when soldering this product.

Please consult with our sales offices in case other soldering process is used, or in case soldering is done under different conditions.

**TYPES OF THROUGH HOLE MOUNT DEVICE**

**μPC24M00AHF Series**

Soldering Process	Soldering Conditions	Symbol
Wave soldering	Solder temperature: 260 °C or below. Flow Time: 10 seconds or below.	

**REFERENCE**

Document Name	Document No.
NEC semiconductor device reliability/quality control system	IEI-1212
Quality grade on NEC semiconductor devices	IEI-1209
Semiconductor device mounting technology manual	IEI-1207
Semiconductor device package manual	IEI-1213
Guide to quality assurance for semiconductor devices	MEI-1202
Semiconductor selection guide	MF-1134

[MEMO]

No part of this document may be copied or reproduced in any form or by any means without the prior written consent of NEC Corporation. NEC Corporation assumes no responsibility for any errors which may appear in this document.

NEC Corporation does not assume any liability for infringement of patents, copyrights or other intellectual property rights of third parties by or arising from use of a device described herein or any other liability arising from use of such device. No license, either express, implied or otherwise, is granted under any patents, copyrights or other intellectual property rights of NEC Corporation or others.

While NEC Corporation has been making continuous effort to enhance the reliability of its semiconductor devices, the possibility of defects cannot be eliminated entirely. To minimize risks of damage or injury to persons or property arising from a defect in an NEC semiconductor device, customer must incorporate sufficient safety measures in its design, such as redundancy, fire-containment, and anti-failure features.

NEC devices are classified into the following three quality grades:

“Standard”, “Special”, and “Specific”. The Specific quality grade applies only to devices developed based on a customer designated “quality assurance program” for a specific application. The recommended applications of a device depend on its quality grade, as indicated below. Customers must check the quality grade of each device before using it in a particular application.

Standard: Computers, office equipment, communications equipment, test and measurement equipment, audio and visual equipment, home electronic appliances, machine tools, personal electronic equipment and industrial robots

Special: Transportation equipment (automobiles, trains, ships, etc.), traffic control systems, anti-disaster systems, anti-crime systems, safety equipment and medical equipment (not specifically designed for life support)

Specific: Aircrafts, aerospace equipment, submersible repeaters, nuclear reactor control systems, life support systems or medical equipment for life support, etc.

The quality grade of NEC devices in “Standard” unless otherwise specified in NEC's Data Sheets or Data Books. If customers intend to use NEC devices for applications other than those specified for Standard quality grade, they should contact NEC Sales Representative in advance.

Anti-radioactive design is not implemented in this product.