

LOW DROPOUT VOLTAGE REGULATOR

■ GENERAL DESCRIPTION

The NJM2819A is a low dropout voltage regulator with ON/OFF control.

Advanced Bipolar technology achieves low noise, high ripple rejection and low quiescent current.

It delivers up to 7V/2A output power with the maximum input voltage of 10V.

The NJM2819A is suitable for audio/video and digital applications.

■ PACKAGE OUTLINE

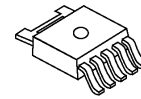

NJM2819ADL3

■ FEATURES

- High Ripple Rejection 65dB typ. (f=1kHz,3V Version)
- Output Noise Voltage $V_{no}=42\mu V_{rms}$ typ. ($V_o=3V$ Version)
- Output capacitor with 4.7 μF ceramic capacitor ($V_o\geq 2.1V$)
- Output Current $I_o(max.)=2.0A$
- High Precision Output $V_o \pm 1.0\%$
- Low Dropout Voltage 0.1V typ. ($I_o=1.0A$, 3.0V Version)
- ON/OFF Control
- Internal Short Circuit Current Limit
- Internal Thermal Overload Protection
- Package Outline TO-252-5

■ PIN CONFIGURATION

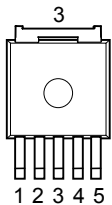

1. V_{IN}
2. CONTROL
3. V_o
4. N.C.
5. GND

NJM2819ADL3

■ EQUIVALENT CIRCUIT

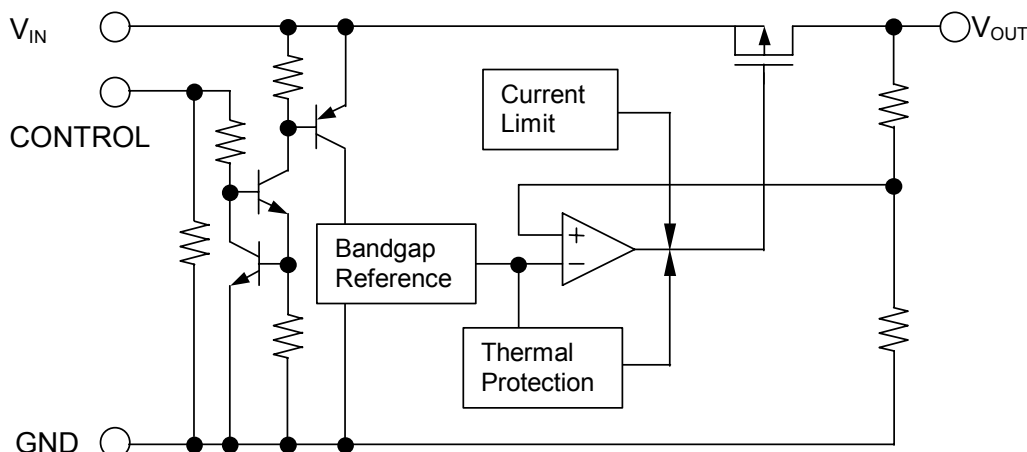

NJM2819A

■ OUTPUT VOLTAGE RANK LIST

Device Name	V _{OUT}
NJM2819ADL3-18	1.8V
NJM2819ADL3-21	2.1V
NJM2819ADL3-03	3.0V
NJM2819ADL3-33	3.3V
NJM2819ADL3-05	5.0V
NJM2819ADL3-52	5.2V
NJM2819ADL3-07	7.0V

Output voltage options available : 1.8 ~ 7.0V

■ ABSOLUTE MAXIMUM RATINGS

(Ta=25°C)

PARAMETER	SYMBOL	RATINGS	UNIT
Input Voltage	V _{IN}	V _O > 6.0V: +10 5.0V < V _O ≤ 6.0V: +9V V _O ≤ 5.0V: +8	V
Control Voltage	V _{CONT}	V _O > 6.0V: +10 5.0V < V _O ≤ 6.0V: +9V V _O ≤ 5.0V: +8	V
Power Dissipation	P _D	1190(*1) 3125(*2)	mW
Operating Temperature	Topr	-40 ~ +85	°C
Storage Temperature	Tstg	-40 ~ +150	°C

(*1) : Mounted on glass epoxy board. (76.2×114.3×1.6mm:EIA/JDEC standard size, 2Layers, copper area 100mm²)

(*2) : Mounted on glass epoxy board. (76.2×114.3×1.6mm:EIA/JDEC standard size, 4Layers, copper area 100mm²)
(4Layers inner foil : 74.2 x 74.2mm Applying a thermal beer hall to a board based on JEDEC standard JESD51-5)

■ OPERATING VOLTAGE

V_{IN}=V_O + ΔV_{I-O} ~ 9V (In case of V_O > 6.0V version)

V_{IN}=V_O + ΔV_{I-O} ~ 8V (In case of 5.0V < V_O ≤ 6.0V version)

V_{IN}=V_O + ΔV_{I-O} ~ 7V (In case of 2.1V ≤ V_O ≤ 5.0V version)

V_{IN}=2.3V ~ 7V (In case of V_O < 2.1V version)

■ ELECTRICAL CHARACTERISTICS ($V_{IN}=V_O+1V$, $C_{IN}=4.7\mu F$, $C_O=4.7\mu F$ ($C_O=10\mu F$: $1.8V \leq V_O < 2.1V$), $T_a=25^\circ C$)

PARAMETER	SYMBOL	TEST CONDITION	MIN.	TYP.	MAX.	UNIT	
Output Voltage	V_O	$I_O=100mA$	-1.0%	-	+1.0%	V	
Quiescent Current	I_Q	$I_O=0mA$, exclude I_{CONT}	-	500	800	μA	
Quiescent Current at Control OFF	$I_{Q(OFF)}$	$V_{CONT}=0V$	-	-	1	μA	
Output Current	I_O	$V_O - 0.3V$	2	3	-	A	
Line Regulation	$\Delta V_O / \Delta V_{IN}$	$V_O > 5.0V$: $V_{IN}=V_O+1V \sim 9V$, $5.0V < V_O \leq 6.0V$: $V_{IN}=V_O+1V \sim 8V$, $V_O \leq 5.0V$: $V_{IN}=V_O+1V \sim 7V$, $I_O=100mA$	-	-	0.1	%/V	
Load Regulation	$\Delta V_O / \Delta I_O$	$I_O=0 \sim 2.0A$	-	0.05	0.4	%/A	
Dropout Voltage(*2)	ΔV_{I-O}	$I_O=1.0A$	$2.1V \leq V_O < 2.5V$	-	0.14	0.25	V
			$2.5V \leq V_O < 2.8V$	-	0.11	0.20	
			$2.8V \leq V_O < 3.4V$	-	0.10	0.18	
			$3.4V \leq V_O \leq 7.0V$	-	0.09	0.16	
Ripple Rejection	RR	$e_{in}=200mV_{rms}$, $f=1kHz$, $I_O=100mA$, $V_O=3V$ Version	-	65	-	dB	
Average Temperature Coefficient of Output Voltage	$\Delta V_O / \Delta T_a$	$T_a=0 \sim 85^\circ C$, $I_O=100mA$	-	± 50	-	ppm/ $^\circ C$	
Output Noise Voltage	V_{NO}	$f=10Hz \sim 80kHz$, $I_O=100mA$, $V_O=3V$ Version	-	42	-	μV_{rms}	
Control Current	I_{CONT}	$V_{CONT}=1.6V$	-	3	12	μA	
Control Voltage for ON-state	$V_{CONT(ON)}$		1.6	-	-	V	
Control Voltage for OFF-state	$V_{CONT(OFF)}$		-	-	0.6	V	
Minimum Input Voltage	$V_{IN(MIN)}$	$V_O < 2.1V$	$I_O \leq 1.5A$, $V_O \times 0.96$	2.3	-	-	V
			$1.5A < I_O \leq 2.0A$, $V_O \times 0.96$	2.4	-	-	V

(*2): The output voltage excludes under 2.1V.

The above specification is a common specification for all output voltages.

Therefore, it may be different from the individual specification for a specific output voltage.

NJM2819A

POWER DISSIPATION vs. AMBIENT TEMPERATURE

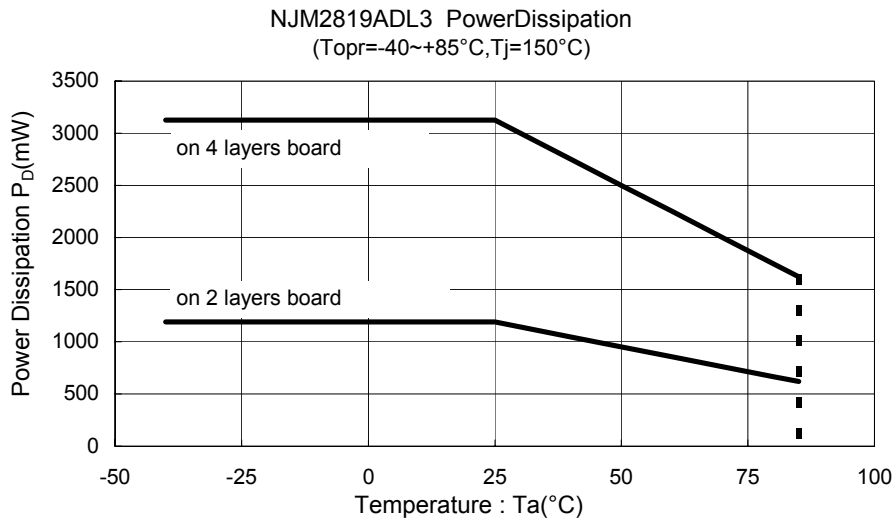

TEST CIRCUIT

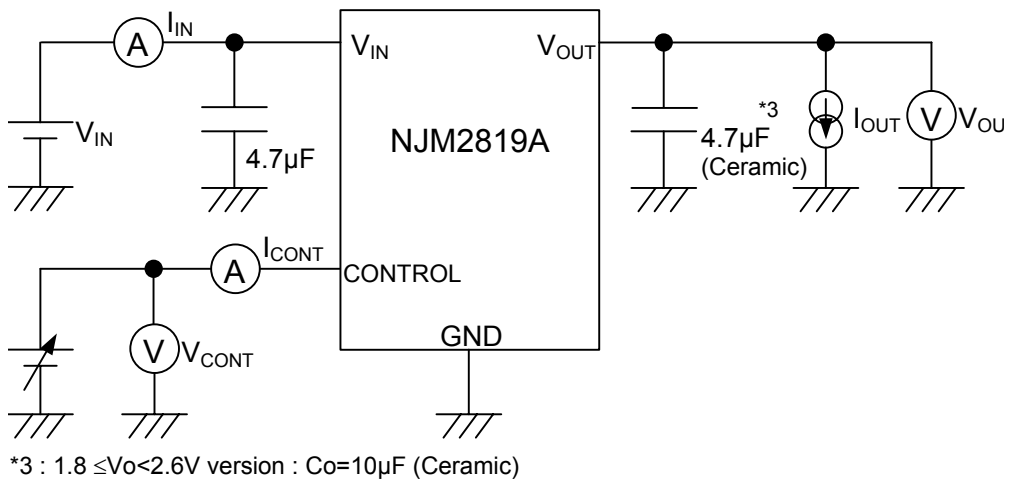

■ TYPICAL APPLICATION

① In the case where ON/OFF Control is not required:

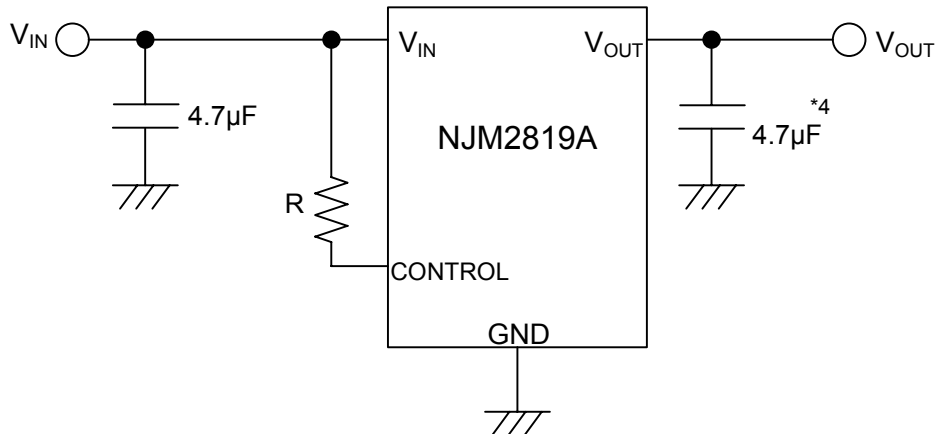

*4 : $1.8 \leq V_o < 2.6V$ version : $C_o = 10\mu F$

Connect control terminal to V_{IN} terminal

② In use of ON/OFF CONTROL:

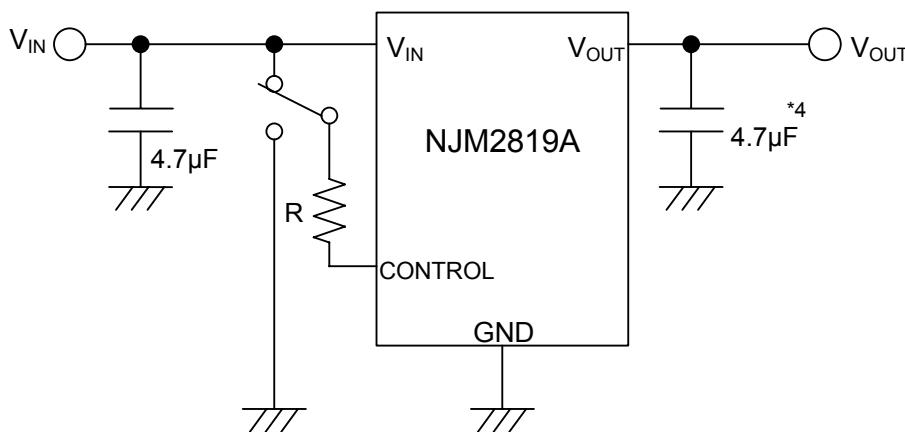

*4 : $1.8 \leq V_o < 2.6V$ version : $C_o = 10\mu F$

State of control terminal:

- "H" → output is enabled.
- "L" or "open" → output is disabled.

*In the case of using a resistance "R" between V_{IN} and control.

The current flow into the control terminal while the IC is ON state (I_{CONT}) can be reduced when a pull up resistance "R" is inserted between V_{IN} and the control terminal.

The minimum control voltage for ON state ($V_{CONT(ON)}$) is increased due to the voltage drop caused by I_{CONT} and the resistance "R". The I_{CONT} is temperature dependence as shown in the "Control Current vs. Temperature" characteristics. Therefore, the resistance "R" should be carefully selected to ensure the control voltage exceeds the $V_{CONT(ON)}$ over the required temperature range.

NJM2819A

*Input Capacitance C_{IN}

Input Capacitance C_{IN} is required to prevent oscillation and reduce power supply ripple for applications with high power supply impedance or a long power supply line.

Use the C_{IN} value of 4.7 μ F greater to avoid the problem.

C_{IN} should connect between GND and V_{IN} as short as possible.

*Output Capacitance C_O

Output capacitor (C_O) is required for a phase compensation of the internal error amplifier. The capacitance and the equivalent series resistance (ESR) influence stability of the regulator.

If use a smaller C_O , it may cause excess output noise or oscillation of the regulator due to lack of the phase compensation. Therefore, use C_O with the recommended capacitance or greater value and connect between V_O terminal and GND terminal with minimal wiring.

The recommended capacitance depends on the output voltage. Low voltage regulator requires greater value of the C_O . Thus, check the recommended capacitance for each output voltage.

Use of a greater C_O reduces output noise and ripple output, and also improves transient response of the output voltage against rapid load change.

This product is designed to work with any capacitor including a low ESR capacitor for the C_O ; however, refer "Equivalent Series Resistance vs. Output Current" and choose suitable capacitor.

- * When distance from an IC to load is long, an IC may cause malfunction by wiring capacity and an L ingredient
Please use it after having evaluated it enough.

TYPICAL CHARACTERISTICS

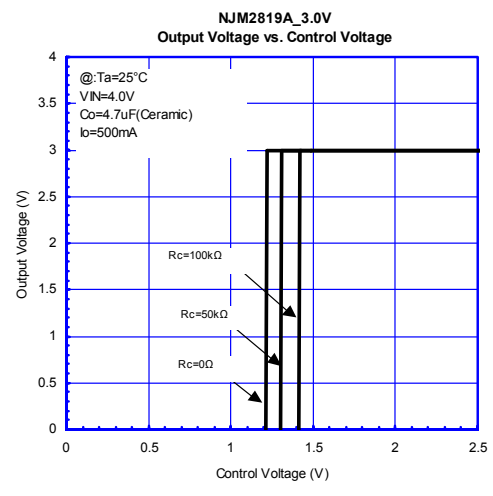
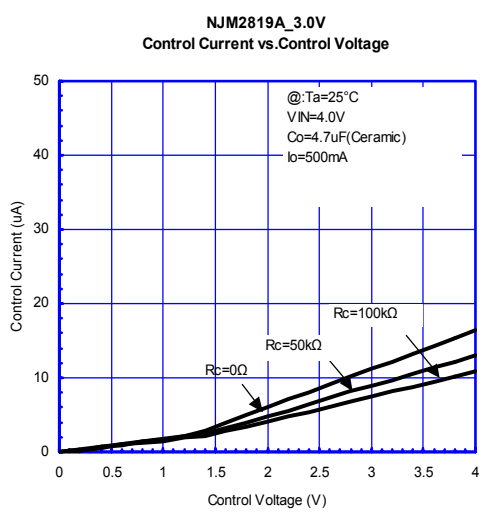
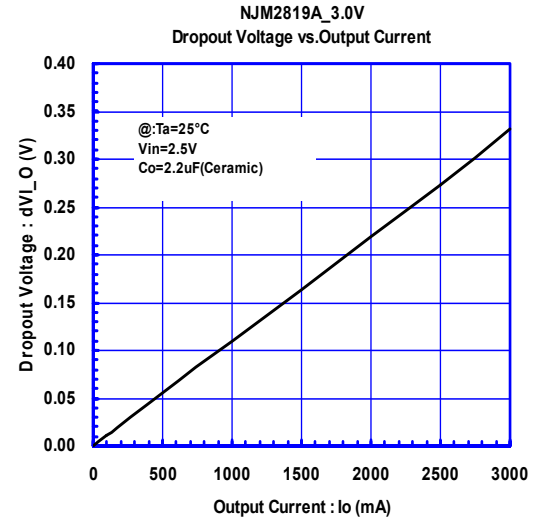
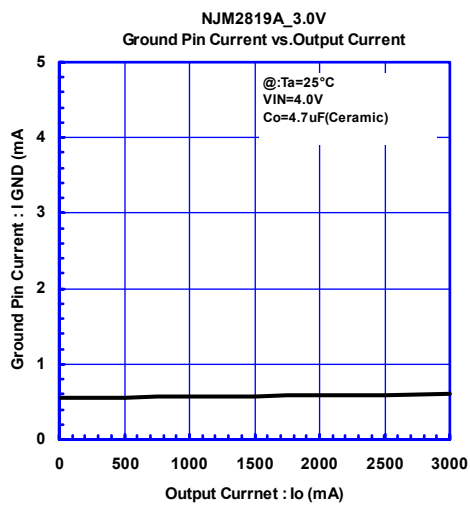
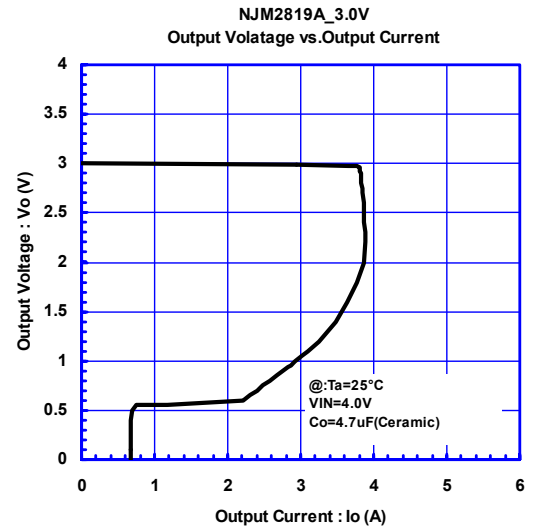
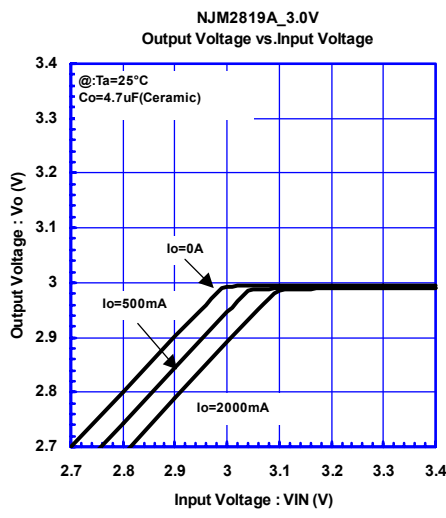

NJM2819A

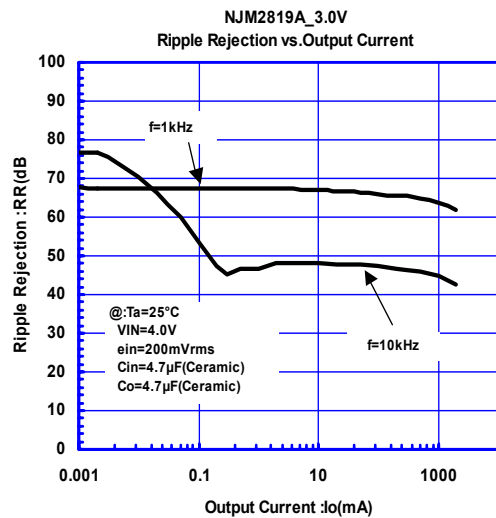
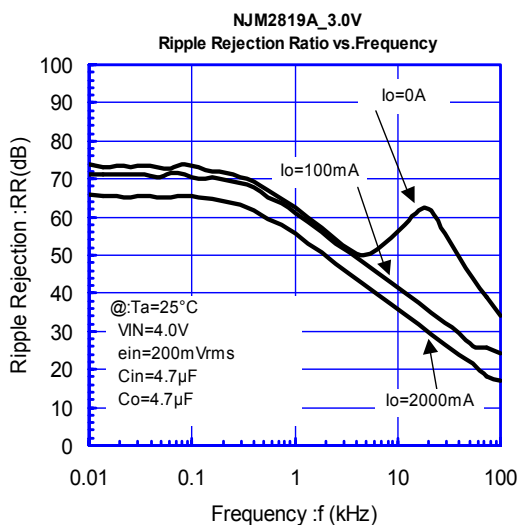
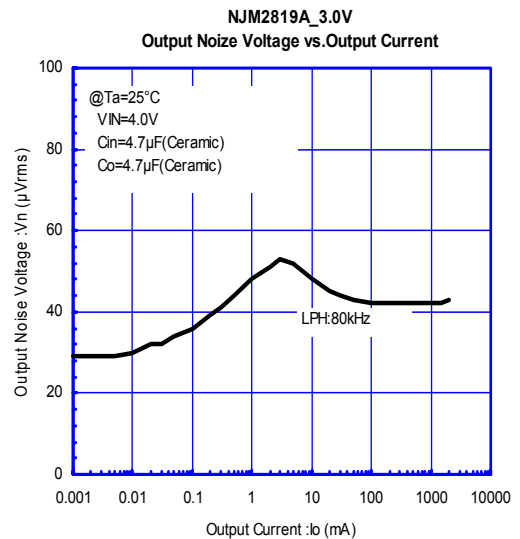
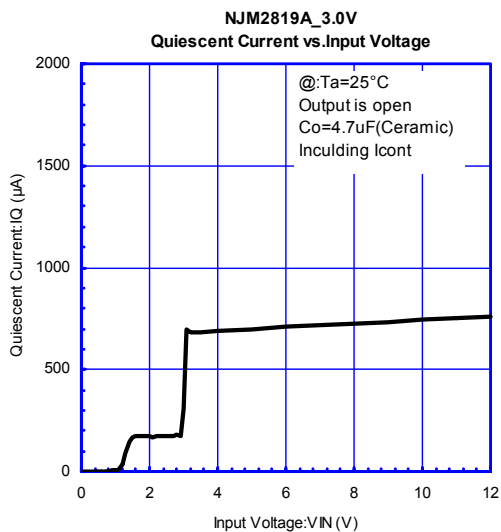
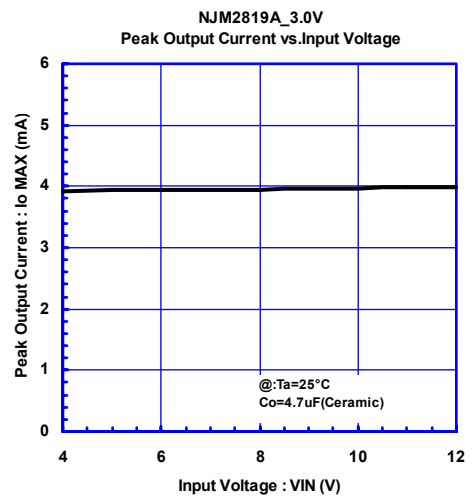
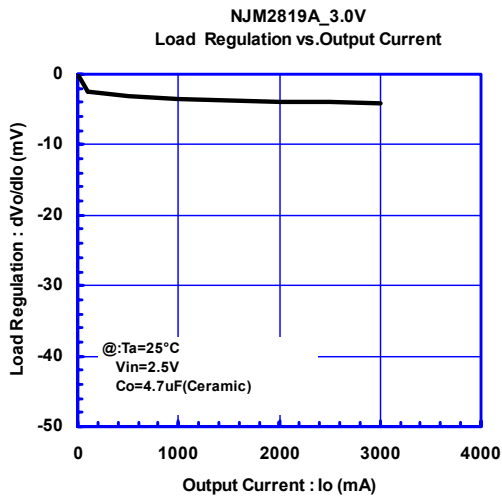

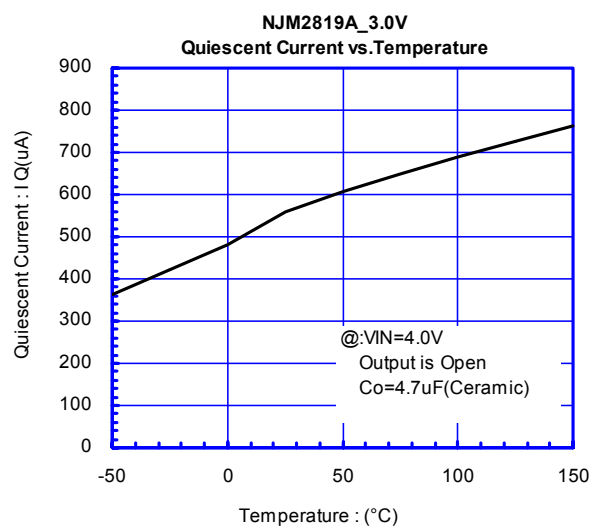
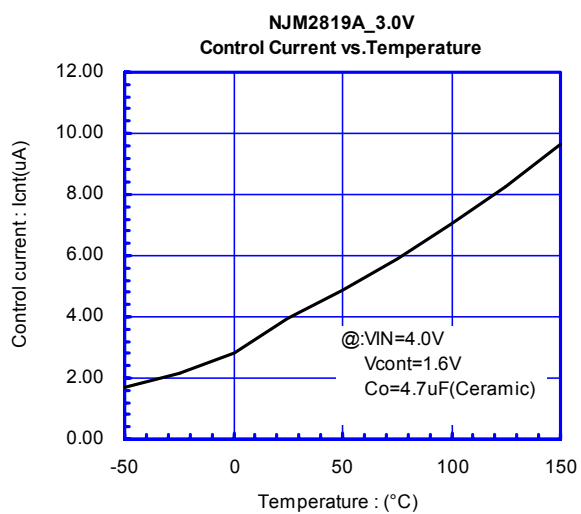
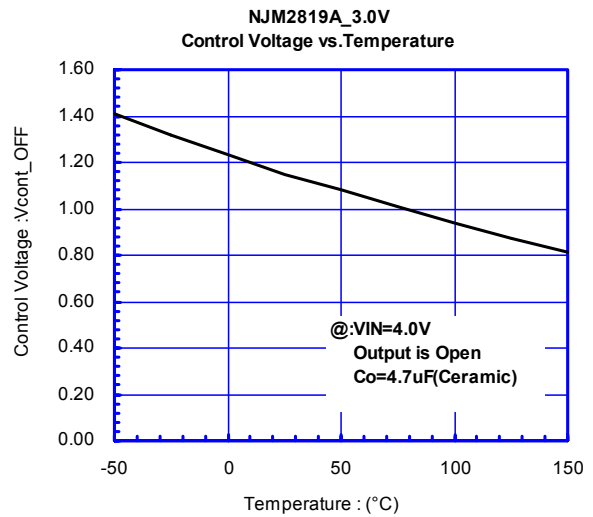
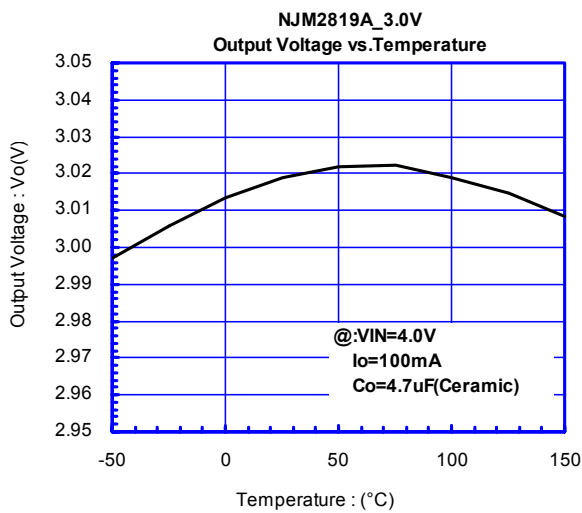
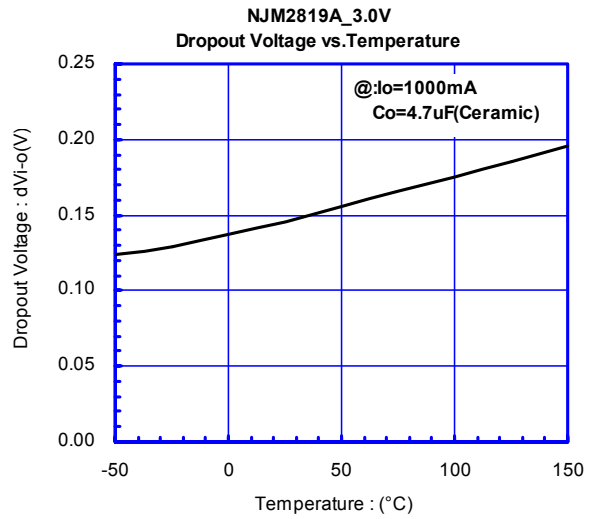
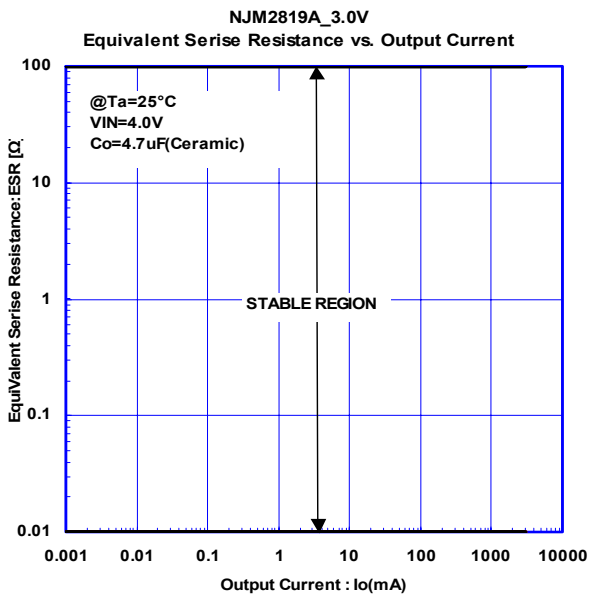

NJM2819A

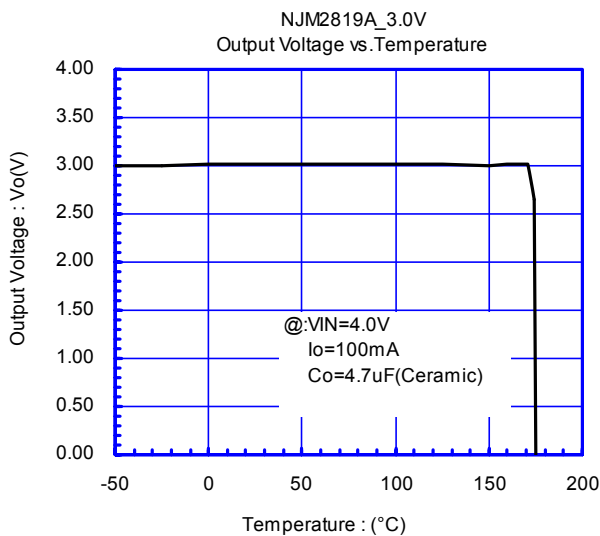
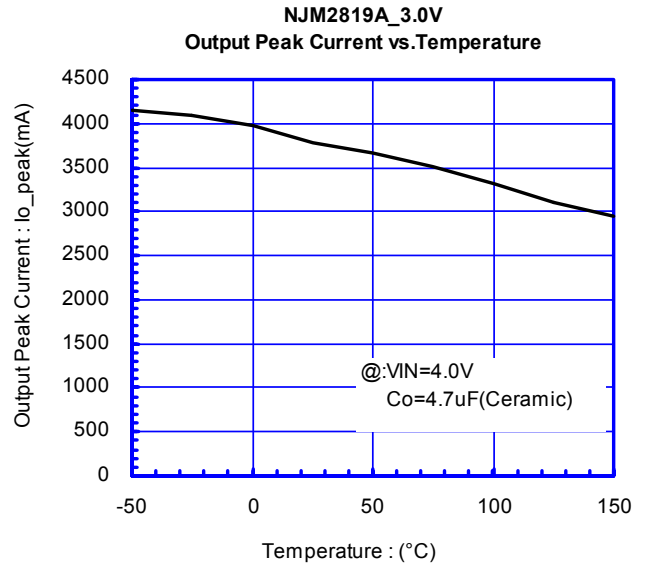
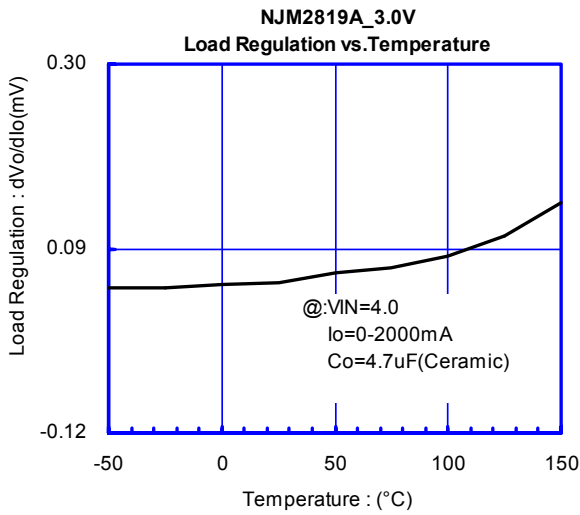
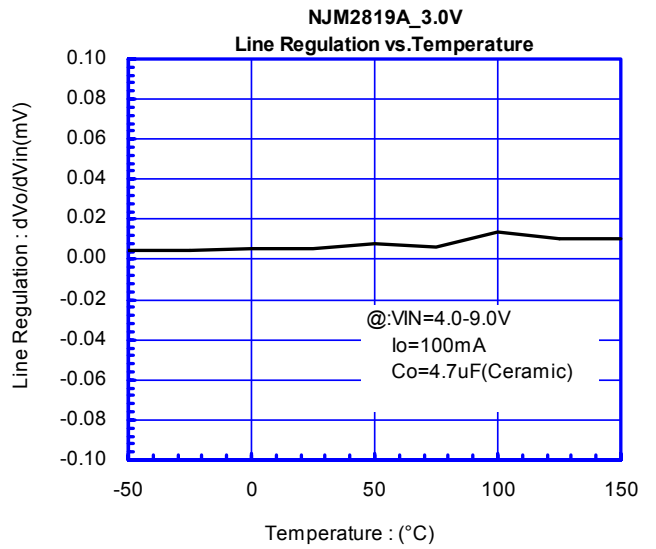
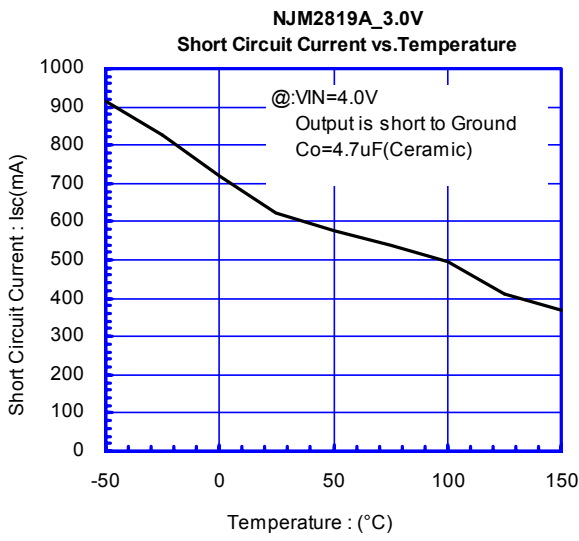

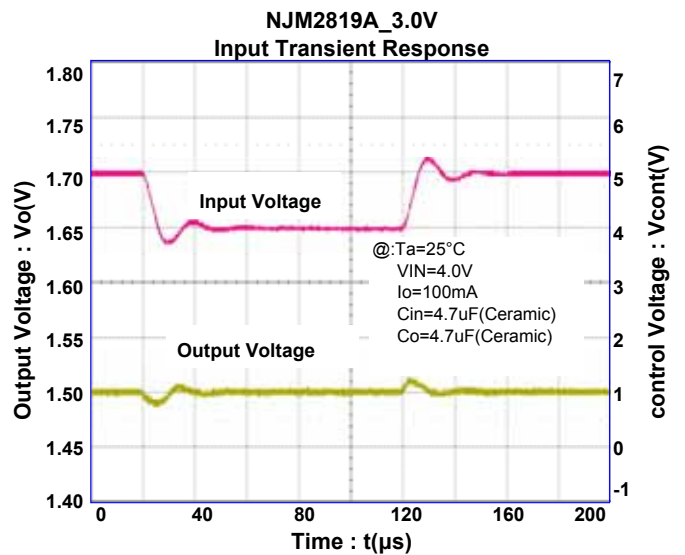
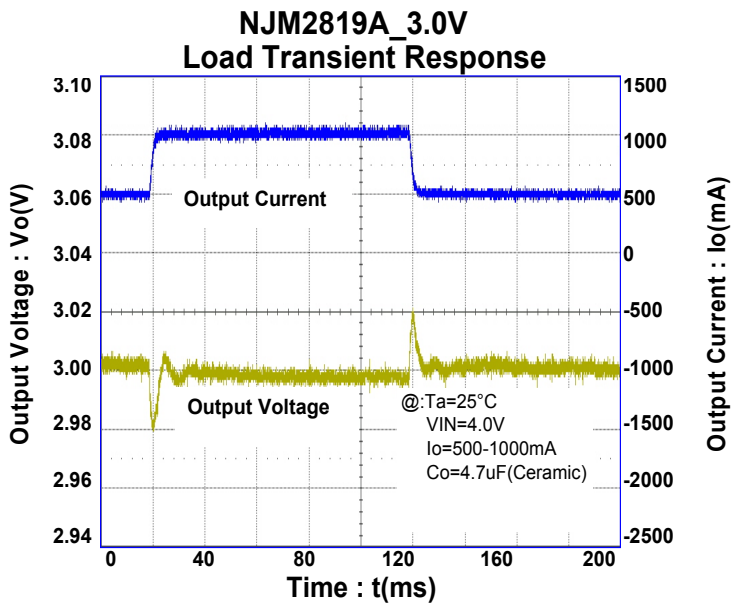
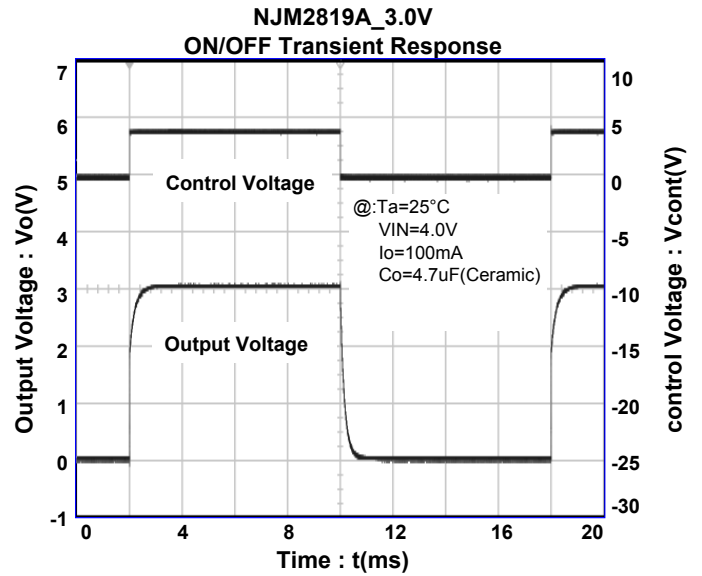
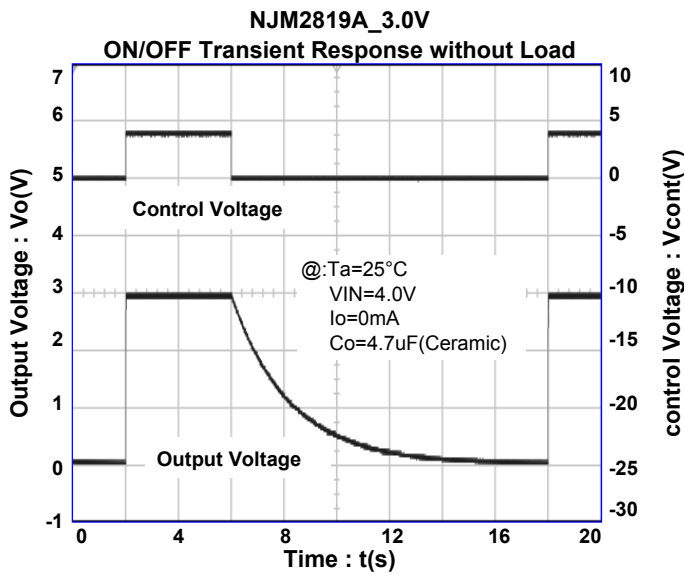

[CAUTION]

The specifications on this databook are only given for information, without any guarantee as regards either mistakes or omissions. The application circuits in this databook are described only to show representative usages of the product and not intended for the guarantee or permission of any right including the industrial rights.