

## DESCRIPTION

The MP20048 is a kind of new low-dropout (LDO) voltage regulators which uses an NMOS as the pass element in a voltage-follower configuration. It can get any value of output from 1.234V to 5V. The benefit of this product is that it can operate without any capacitors.

The MP20048 uses an advanced BICMOS process to yield high precision. It also delivers very low dropout voltage and low ground pin current. It integrates the thermal-off and current limit block to protect the devices from damage. The MP20048 is available in a TSOT23-5 package.

## FEATURES

- Stable with No Output Capacitor or Any Capacitors
- Input Voltage Range: 1.7V to 5.5V
- Output Voltage Range: 1.234V to 5V
- 62.5mV Dropout at 250mA Load
- 1% Accuracy for Initial Reference
- Thermal off and Current Limit Protection
- Available in a TSOT23-5 package

## APPLICATIONS

- VCOs
- Portable/Battery-Powered Equipment
- Post-Regulation for Switching Supplies
- Point of Load Regulation for DSPs, FPGAs, ASICs, and Microprocessors

"MPS" and "The Future of Analog IC Technology" are Registered Trademarks of Monolithic Power Systems, Inc.

## TYPICAL APPLICATION

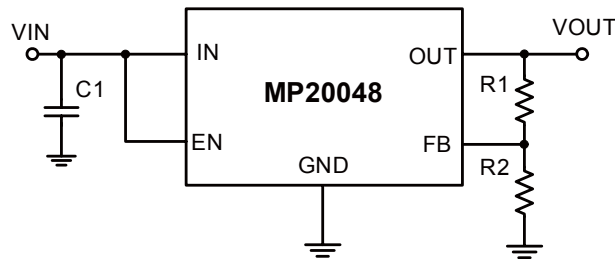

Typical Application Circuit

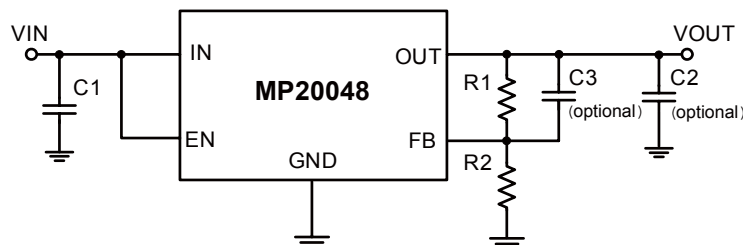

Typical Application Circuit with optional output cap and feedforward cap

### ORDERING INFORMATION

Part Number*	Package	Top Marking	Free Air Temperature (T <sub>A</sub> )
MP20048DJ	TSOT23-5	3B	-40°C to +85°C

\*For Tape & Reel, add suffix -Z (eg. MP20048DJ-Z)

For Lead Free, add suffix -LF (eg. MP20048DJ-LF-Z)

### PACKAGE REFERENCE

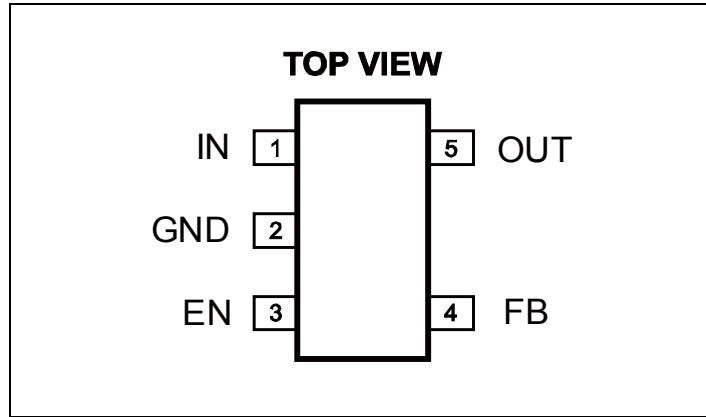

#### ABSOLUTE MAXIMUM RATINGS <sup>(1)</sup>

Supply Input Voltage .....	6V
Power Dissipation, P <sub>D</sub> @ T <sub>A</sub> =25°C <sup>(2)</sup>	0.45W
Operating Junct. Temp (T <sub>J</sub> ) .....	-40°C to 125°C
Storage Temperature Range .....	-65°C to 150°C
Lead Temperature (Soldering, 10sec) .....	260°C

#### ESD Susceptibility <sup>(3)</sup>

HBM (Human Body Mode) .....	2kV
MM (Machine Mode) .....	500V

#### Recommended Operating Conditions <sup>(4)</sup>

Supply Input Voltage .....	1.7V to 5.5V
Enable Input Voltage .....	0V to 5.5V
Junction Temperature .....	+125°C

#### Thermal Resistance <sup>(5)</sup>

	$\theta_{JA}$	$\theta_{JC}$
TSOT23-5 .....	220	110

°C/W

#### Notes:

- Exceeding these ratings may cause permanent damage to the device.
- The maximum allowable power dissipation is a function of the maximum junction temperature T<sub>J</sub>(MAX), the junction-to-ambient thermal resistance  $\theta_{JA}$ , and the ambient temperature T<sub>A</sub>. The maximum allowable continuous power dissipation at any ambient temperature is calculated by P<sub>D</sub>(MAX)=(T<sub>J</sub>(MAX)-T<sub>A</sub>)/ $\theta_{JA}$ . Exceeding the maximum allowable power dissipation will cause excessive die temperature, and the regulator will go into thermal shutdown. Internal thermal shutdown circuitry protects the device from permanent damage.
- Devices are ESD sensitive. Handling precaution recommended.
- The device is not guaranteed to function outside its operating conditions.
- Measured on JESD51-7 4-layer board.

## ELECTRICAL CHARACTERISTICS <sup>(6)</sup>

$V_{IN} = V_{OUT(nom)} + 0.5V^{(6)}$ ,  $V_{OUT}=2.5V$ ,  $V_{EN}=1.7V$ ,  $C_2=0.1\mu F$ ,  $T_A = 25^\circ C$ , unless otherwise noted.

Parameters		Test Condition	Min	Typ	Max	Unit
$V_{IN}$	Input voltage range <sup>(6)</sup>		1.7		5.5	V
$V_{FB}$	Internal reference	$T_A=25^\circ C$	1.221	1.234	1.247	V
	Accuracy		-1.0		+1.0	%
$V_{OUT}$	Output voltage range <sup>(7)</sup>		$V_{FB}$		5.5- $Z_o(DO)^*$ $I_{OUT}$	V
$\Delta V_{OUT\%}/\Delta V_{IN}$	Line regulation <sup>(8)</sup>	$1.7V \leq V_{IN} \leq 5.5V$		0.01		%/V
$\Delta V_{OUT\%}/\Delta I_{OUT}$	Load regulation <sup>(9)</sup>	$1mA \leq I_{OUT} \leq 250mA$		0.0005		%/mA
$V_{DO}$	Dropout Voltage <sup>(10)</sup>	$I_{OUT}=250mA$		62.5		mV
$Z_o(DO)$	Output impedance in dropout	$1.7V \leq V_{IN} \leq 5.5V$		0.25		$\Omega$
$I_{CL}$	Output current limit	$V_{OUT}=0.9 \times V_{OUT(nom)}$	270	450		mA
$I_{SC}$	Short-circuit current	$V_{OUT}=0V$		430		mA
$I_{GND}$	Ground pin current	$I_{OUT}=10mA$		350		$\mu A$
		$I_{OUT}=100mA$		500	800	$\mu A$
$I_{SHDN}$	Shutdown current ( $I_{GND}$ )	$V_{EN} \leq 0.5V, V_{OUT} \leq V_{IN} \leq 5.5V$		0.01	1	$\mu A$
$I_{LEAK}$	Output leakage	$V_{EN} \leq 0.5V, V_{OUT} \leq V_{IN} \leq 5.5V$ $-40^\circ C \leq T_J \leq +125^\circ C$			6.5	$\mu A$
PSRR	Power-supply rejection ratio (ripple rejection)	$I_{OUT}=250mA$	$f=100Hz$		48	dB
			$f=10kHz$		23	
VN	Output noise voltage BW=10Hz—100kHz	$C_2=10\mu F, No C_3$	48			$\mu V_{RMS}$
		$C_2=10\mu F, C_3=0.01\mu F$	37			
$t_{STR}$	Startup time	$V_{OUT}=2.5V, R_L=25\Omega, C_2=1\mu F$	0.5			ms
$V_{EN(HI)}$	Enable high (enabled)		1.7		$V_{IN}$	V
$V_{EN(LO)}$	Enable low (shutdown)		0		0.5	V
$T_{SD}$	Thermal shutdown temperature	Shutdown Temp increasing		+140		$^\circ C$
		Reset Temp decreasing		+130		$^\circ C$
$T_J$	Operating junction temperature				125	$^\circ C$

### Notes:

6) Minimum  $V_{IN}=V_{OUT}+V_{DO}$  or 1.7V

7) This version is tested at  $V_{OUT}=2.5V$

$$8) \text{ Line Regulation} = \frac{V_{OUT}[V_{IN(MAX)}] - V_{OUT}[V_{IN(MIN)}]}{[V_{IN(MAX)} - V_{IN(MIN)}] \times V_{OUT(NOM)}} \times 100(\%/V)$$

$$9) \text{ Load Regulation} = \frac{V_{OUT}[I_{OUT(MAX)}] - V_{OUT}[I_{OUT(MIN)}]}{V_{OUT(NOM)}} \times 100(\%)$$

10) Dropout voltage is defined as the input to output differential when the output voltage drops 100mV below its nominal value.

**PIN FUNCTIONS**

<b>Package Pin #</b>	<b>Name</b>	<b>Description</b>
1	IN	Regulator Input. Supply voltage ranges from +1.7V to 5.5V.
2	GND	Ground
3	EN	Positive polarity enable(EN) input
4	FB	Feedback voltage for setting output voltage of the device.
5	OUT	Regulator output. It can be stable without output capacitor

## TYPICAL PERFORMANCE CHARACTERISTICS

$V_{IN}=3V$ ,  $V_{OUT}=2.5V$ ,  $V_{EN}=1.7V$ ,  $C_1=1\mu F$ ,  $C_2=0.1\mu F$ , no  $C_3$ ,  $T_A=25^\circ C$ , unless otherwise noted

**Ground Pin Current vs. Temperature**

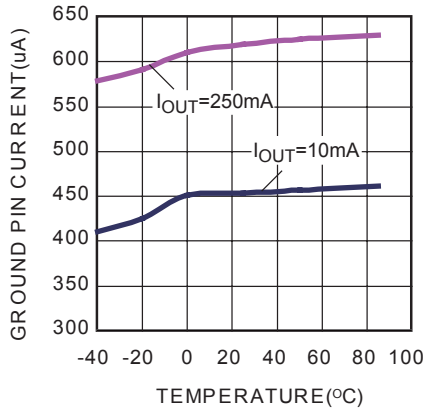

**Ground Pin Current vs. Output Current**

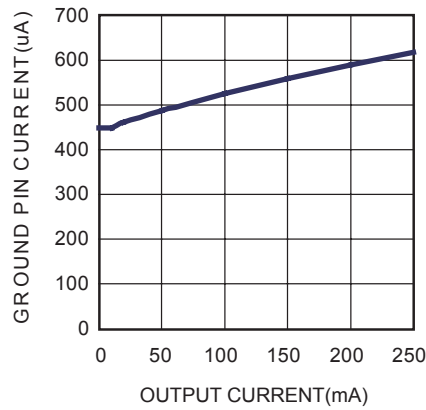

**Dropout Voltage vs. Temperature**

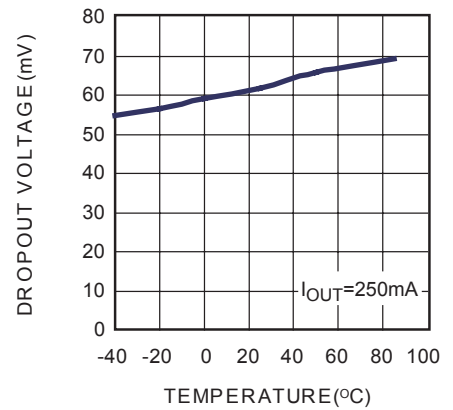

**Dropout Voltage vs. Output Current**

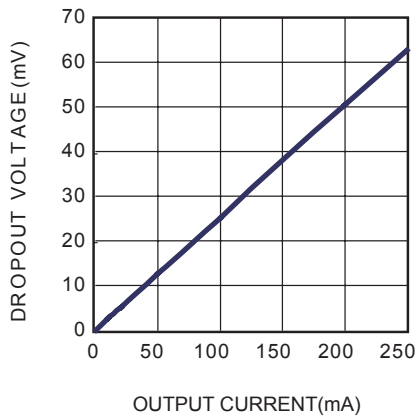

**EN threshold vs. Input Voltage**

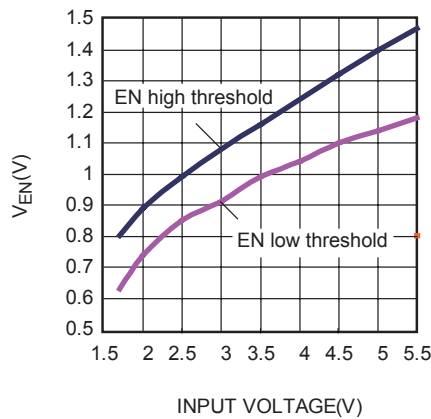

**EN threshold vs. Temperature**

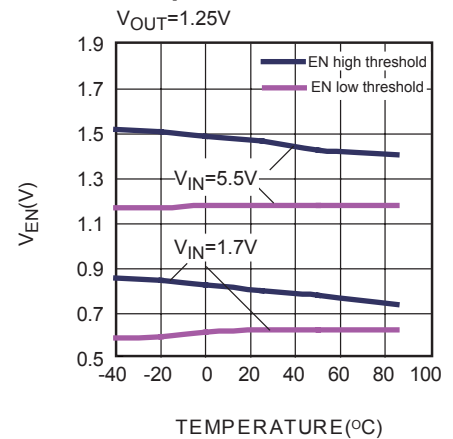

**Current Limit vs. Temperature**

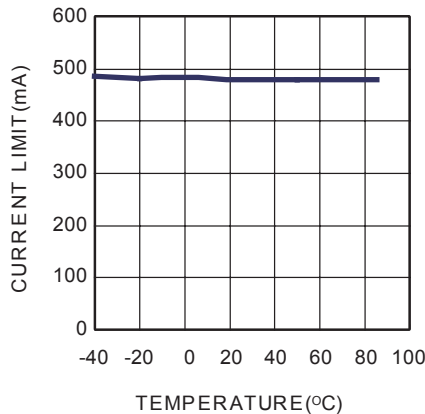

**Current Limit vs. Input Voltage**

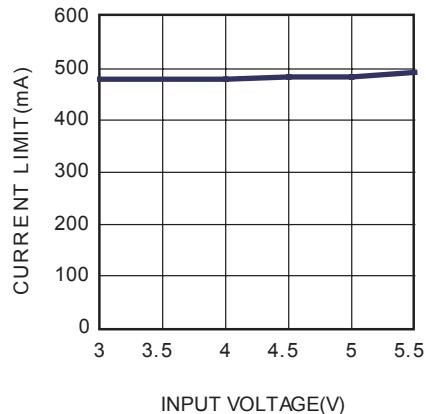

**Line Regulation**

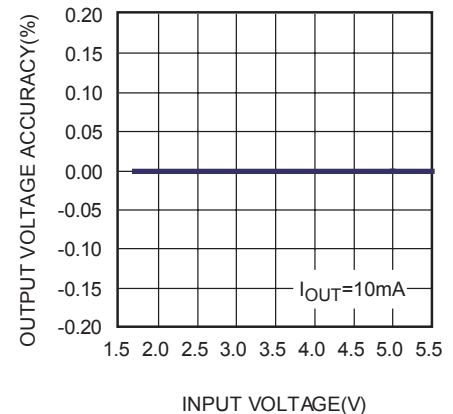

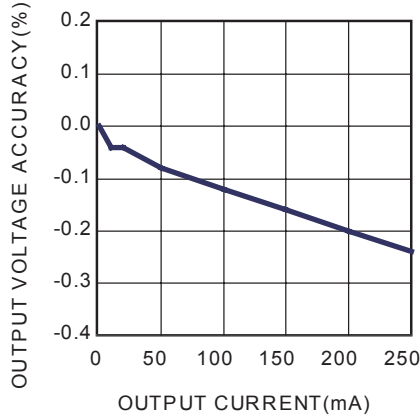
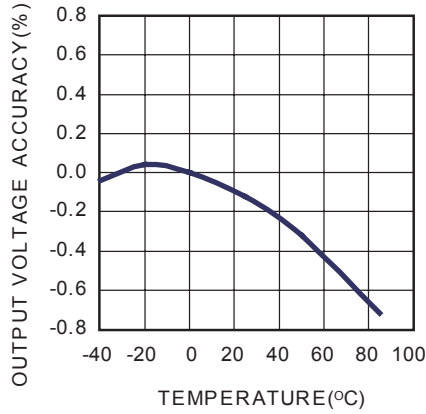
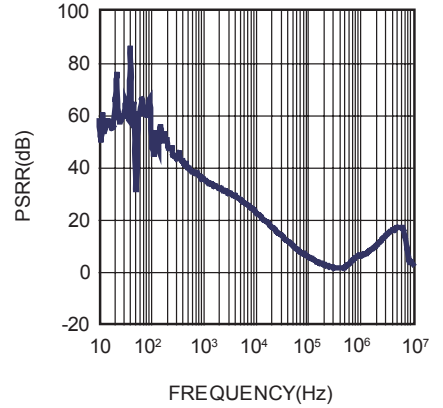
**TYPICAL PERFORMANCE CHARACTERISTICS(continued)**
 $V_{IN}=3V, V_{OUT}=2.5V, V_{EN}=1.7V, C_1=1\mu F, C_2=0.1\mu F, \text{ no } C_3, T_A=25^\circ C, \text{ unless otherwise noted.}$ 
**Load Regulation**

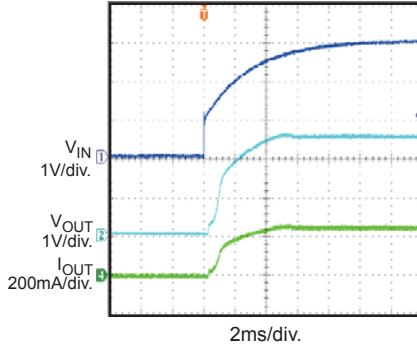
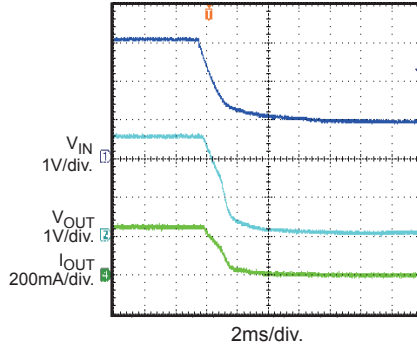
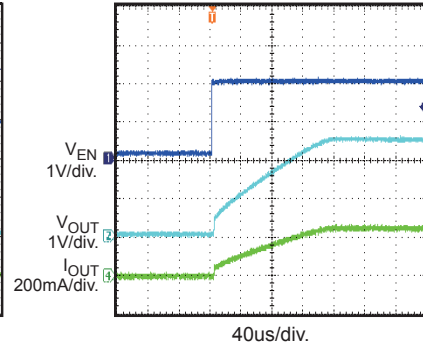
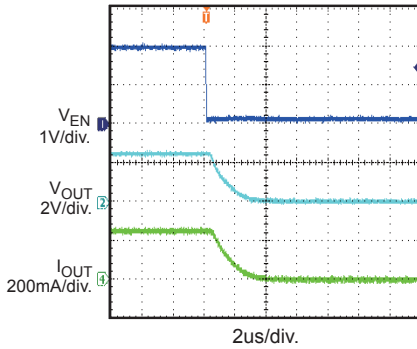
**Output Voltage Accuracy vs. Temperature**

**PSRR**

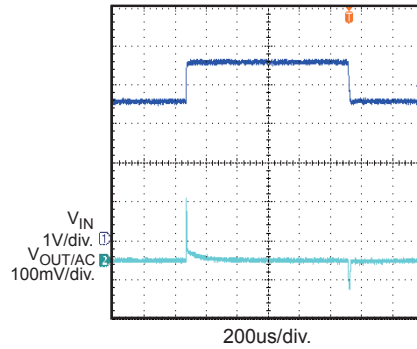
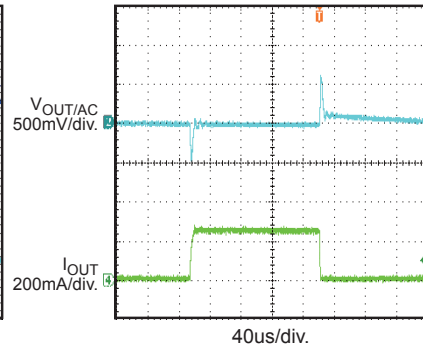
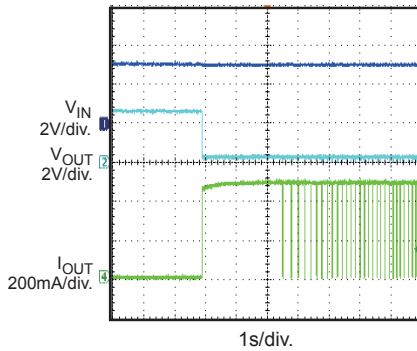
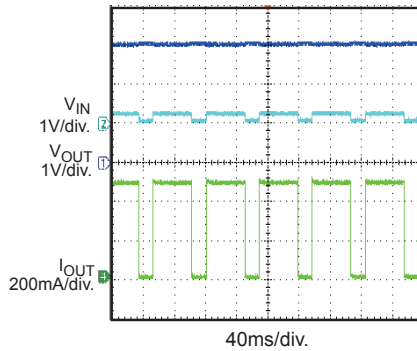
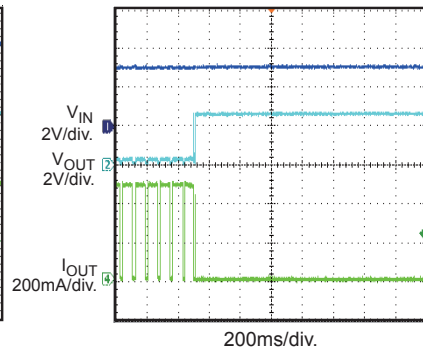
**TYPICAL PERFORMANCE CHARACTERISTICS(continued)**
 $V_{IN}=3V, V_{OUT}=2.5V, V_{EN}=1.7V, C_1=1\mu F, C_2=0.1\mu F, \text{no } C_3, T_A=25^\circ C, \text{ unless otherwise noted.}$ 
**Input Power Start Up  
with Resistive Load**  
 $I_{OUT}=250mA$ 

**Input Power Shut Down  
with Resistive Load**  
 $I_{OUT}=250mA$ 

**EN Start Up  
with Resistive Load**  
 $I_{OUT}=250mA$ 

**EN Shut Down  
with Resistive Load**  
 $I_{OUT}=250mA$ 

MP###-TPC##

**Line Transient  
with Resistive Load**  
 $V_{IN}=3.5V-4.5V, V_{OUT}=2.5V,$   
 $C_1=0, I_{OUT}=250mA$ 

**Load Transient  
with Resistive Load**  
 $I_{OUT}=10mA-250mA$ 

**Over Current Protection  
Entry**

**Over Current Protection  
Steady State**

**Over Current Protection  
Recovery**

**BLOCK DIAGRAM**

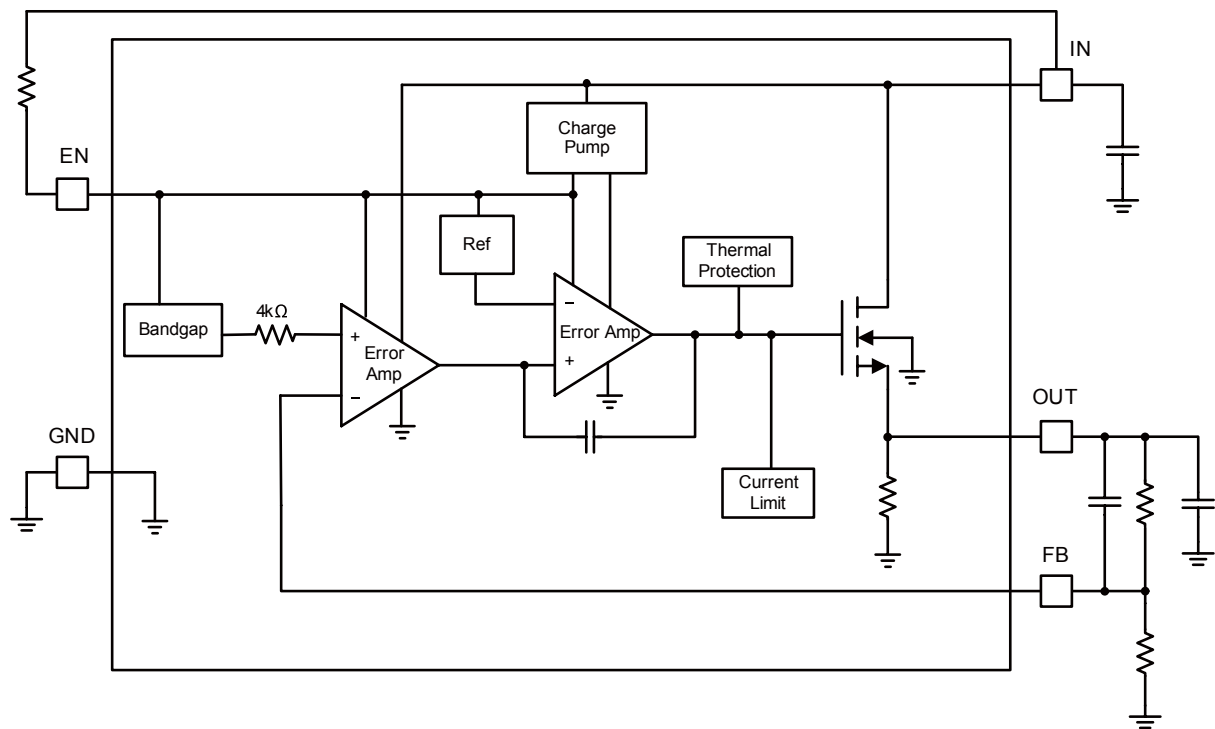

Figure1—Functional Block Diagram

**OPERATION**

The MP20048 is a kind of new low-dropout (LDO) voltage regulators which uses an NMOS as the pass element in a voltage-follower configuration. The highlight of this topology is the stability even without outside capacitor. It can get any value of output between 1.234V to 5V.

The MP20048 uses an advanced BICMOS process to yield high precision. It also delivers very low dropout voltages and low ground pin current and features the thermal-off and current limit block to protect the devices from damage.

**Dropout Voltage**

Dropout voltage is the minimum input to output differential voltage required for the regulator to maintain an output voltage within 100mV of its nominal value. Because the NMOS pass element behaves as a low-value resistor, the dropout voltage of MP20048 is very low.

**Enable Pin and Shutdown**

The MP20048 can be switched ON or OFF by a logic input at the EN pin. A high voltage at this pin will turn the device on. When the EN pin is

low, the regulator output is off. The EN pin should be tied to  $V_{IN}$  to keep the regulator output always on if the application does not require the shutdown feature. Do not float the EN pin.

**Current Limit**

The MP20048 includes a current limit structure which monitors and controls NMOS's gate voltage to limit the guaranteed maximum output current to 450mA.

**Thermal Protection**

Thermal protection turns off the NMOS when the junction temperature exceeds +140°C, allowing the IC to cool. When the IC's junction temperature drops by 10°C, the NMOS will be turned on again. Thermal protection limits total power dissipation in the MP20048. For reliable operation, junction temperature should be limited to 125 °C maximum.



## APPLICATION INFORMATION

### Setting the Output Voltage

The output voltage of MP20048 can get any value of output between 1.234V to 5V. The voltage divider divides the output voltage down to the feedback voltage by the ratio:

$$V_{FB} = V_{OUT} \frac{R2}{R1+R2}$$

Where  $V_{FB}$  is the feedback threshold voltage ( $V_{FB} = 1.234V$ ), and  $V_{OUT}$  is the output voltage. Thus the output voltage is:

$$V_{OUT} = 1.234 \times \frac{R1+R2}{R2}$$

R2 can be as high as 100kΩ, but a typical value is 10kΩ. Using that value, R1 is determined by:

$$R1 = R2 \times \left( \frac{V_{OUT} - V_{FB}}{V_{FB}} \right)$$

For example, for a 2.5V output voltage, R2 is 10kΩ, and R1 is 10.2kΩ. You can select a standard 10.2kΩ (±1%) resistor for R1.

### Power Dissipation

The power dissipation for any package depends on the thermal resistance of the case and circuit board, the temperature difference between the junction and ambient air, and the rate of air flow. The power dissipation across the device can be represented by the equation:

$$P = (V_{IN} - V_{OUT}) \times I_{OUT}$$

The allowable power dissipation can be calculated using the following equation:

$$P_{(MAX)} = (T_{Junction} - T_{Ambient}) / \theta_{JA}$$

Where  $(T_{Junction} - T_{Ambient})$  is the temperature difference between the junction and the surrounding environment,  $\theta_{JA}$  is the thermal resistance from the junction to the ambient environment.

### Output Capacitor Selection

The MP20048 does not require the output capacitor for stable operation. It is specifically designed to be stable with any type and value capacitor including ceramic and electrolytic. Although an output capacitor is not required for stability, the output capacitor, C2, is optional to be connected at the output side. (Figure 2) Output capacitor of larger values will help to improve load transient response and reduce output noise with the drawback of increasing size.

### Output Noise

A precision bandgap reference is used to generate the internal reference voltage,  $V_{REF}$ , which is the dominant noise source within the MP20048. It is optional to connect a feed forward capacitor, C3, from the output to feedback to improve load transient performance. This capacitor, C3, should be limited to be less than 0.1uF. (Figure 2)

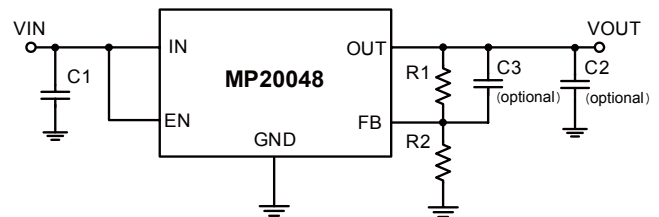

**Figure2. Typical Application Circuit with optional output cap and feedforward cap**

**PACKAGE INFORMATION**

**TSOT23-5**

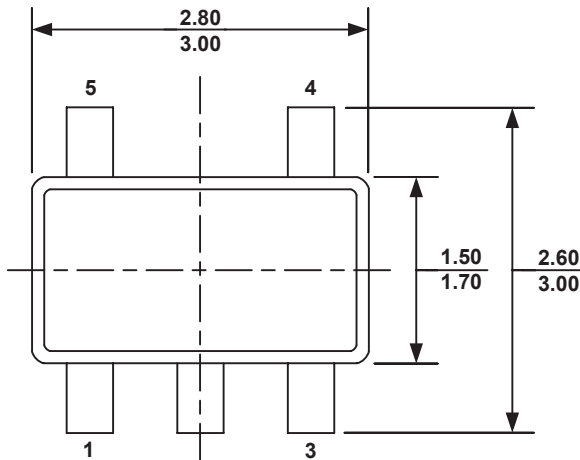

**TOP VIEW**

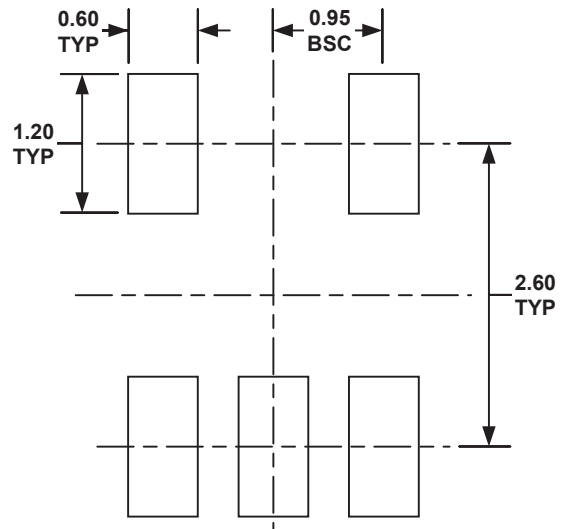

**RECOMMENDED LAND PATTERN**

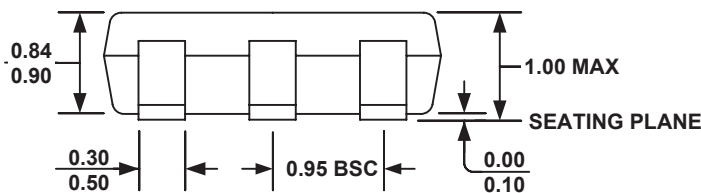

**FRONT VIEW**

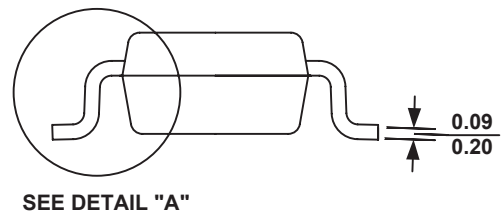

**SIDE VIEW**

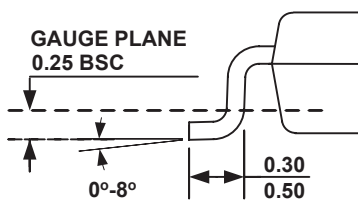

**DETAIL A**

**NOTE:**

- 1) ALL DIMENSIONS ARE IN MILLIMETERS.
- 2) PACKAGE LENGTH DOES NOT INCLUDE MOLD FLASH, PROTRUSION OR GATE BURR.
- 3) PACKAGE WIDTH DOES NOT INCLUDE INTERLEAD FLASH OR PROTRUSION.
- 4) LEAD COPLANARITY (BOTTOM OF LEADS AFTER FORMING) SHALL BE 0.10 MILLIMETERS MAX.
- 5) DRAWING CONFORMS TO JEDEC MO-193, VARIATION AA.
- 6) DRAWING IS NOT TO SCALE.

**NOTICE:** The information in this document is subject to change without notice. Please contact MPS for current specifications. Users should warrant and guarantee that third party Intellectual Property rights are not infringed upon when integrating MPS products into any application. MPS will not assume any legal responsibility for any said applications.