

Super low on resistance/Low voltage LDO

NO.EA-123-220509

OUTLINE

The R1173x Series are CMOS-based positive voltage regulator ICs. The R1173x Series have features of super low dropout, 1A output current capability, and -3mV typical load regulation at 1A. Even the output voltage is set at 1.5V, on resistance of internal FET is typically 0.32Ω. Therefore, applications that require a large current at small dropout are suitable for the R1173x series. Low input voltage is acceptable and low output voltage can be set. The minimum input voltage is 1.4V, and the lowest set output voltage is 0.8V. Each of these ICs consists of a voltage reference unit, an error amplifier, resistor net for setting output voltage, a current limit circuit at over-current, a chip enable circuit, a thermal-shutdown circuit, and so on. A stand-by mode with ultra low consumption current can be realized with the chip enable pin. The output voltage types of R1173 are fixed one in the IC and adjustable one (R1173x001x).

Since the packages for these ICs are the SOT-89-5 package, HSON-6, or HSOP-6J, high density mounting of the ICs on boards is possible.

FEATURES

- Output Current 1A
- Supply Current Typ. 60μA
- Standby Current Typ. 0.1μA
- Input Voltage Range 1.4V to 6.0V
- Output Voltage Range 0.8V to 5.0V (0.1V steps) (R1173xxx1)
1.0V to V_{IN} (R1173x001)
(For other voltages, please refer to MARK INFORMATIONS.)
- Dropout Voltage Typ. 0.32V (V_{OUT}=1.5V, I_{OUT}=1A)
Typ. 0.18V (V_{OUT}=2.8V, I_{OUT}=1A)
- Ripple Rejection Typ. 70dB (V_{OUT}=2.8V)
- Output Voltage Accuracy ±2.0%
- Temperature-drift Coefficient of Output Voltage Typ. ±100ppm/°C
- Line Regulation Typ. 0.05%/V
- Load Regulation Typ. -2mV (I_{OUT}=300mA)
Typ. -3mV (I_{OUT}=1A)
- Packages SOT-89-5, HSON-6, HSOP-6J
- Low inrush current at turning-on Typ. 500mA
- Built-in Thermal Shutdown Circuit
- Built-in Current Limit Circuit Typ. 250mA
- Output capacitors C_{IN}=Ceramic 4.7μF
C_{OUT}=Tantalum 4.7μF (V_{OUT}<1.0V)
C_{OUT}=Ceramic 4.7μF (V_{OUT} ≥ 1.0V)

APPLICATIONS

- Local Power source for Notebook PC.
- Local Power source for portable communication equipments, cameras, and videos.
- Local Power source for home appliances.

BLOCK DIAGRAMS

R1173xxx1B

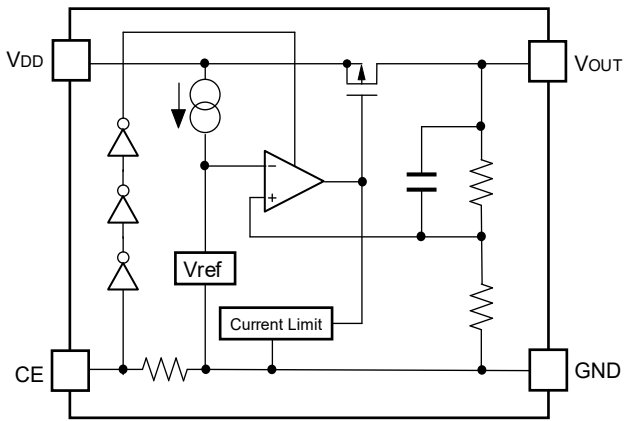

R1173xxx1D

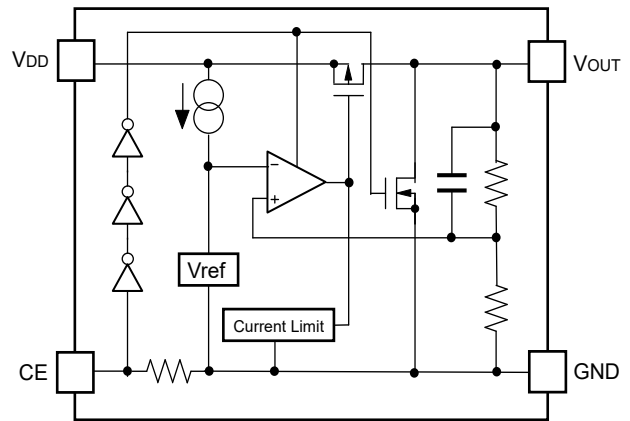

R1173x001B

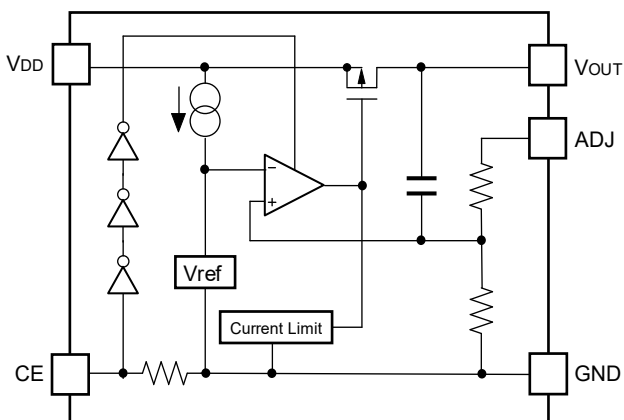

R1173x001D

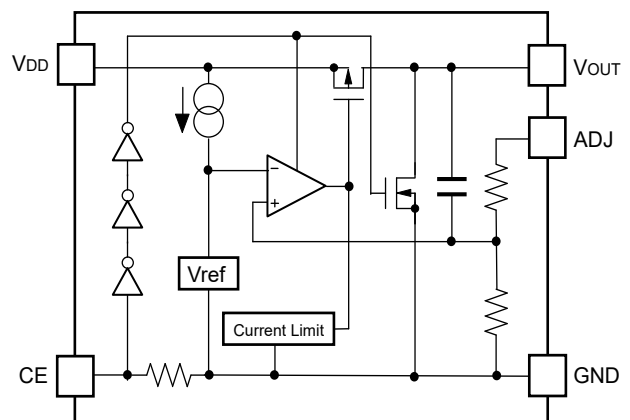

SELECTION GUIDE

The output voltage, auto discharge function, package for the ICs can be selected at the user's request.

Product Name	Package	Quantity per Reel	Pb Free	Halogen Free
R1173Dxx1*-TR-FE	HSOP-6	3,000 pcs	Yes	Yes
R1173Hxx1*-T1-FE	SOT-89-5	1,000 pcs	Yes	Yes
R1173Sxx1*-E2-FE	HSOP-6J	1,000 pcs	Yes	Yes

xx: The output voltage can be designated in the range from 0.8V(08) to 5.0V(50) in 0.1V steps.

External Setting Type: 00 (ADJ pin voltage is fixed at 1.0V.)

(For other voltages, please refer to MARK INFORMATIONS.)

* : The auto discharge function at off state are options as follows.

(B) "H" active, without auto discharge function at off state

(D) "H" active, with auto discharge function at off state

PIN CONFIGURATIONS

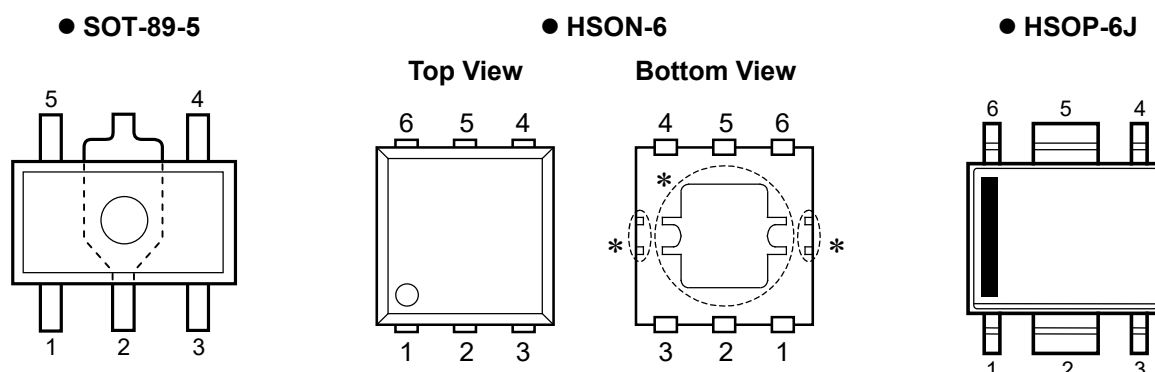

PIN DESCRIPTIONS

●SOT-89-5

Pin No.	Symbol	Description
1	ADJ	ADJUST Pin (R1173H001x)
	NC	No Connection (R1173Hxx1x)
2	GND	Ground Pin
3	CE	Chip Enable Pin ("H" Active)
4	V _{DD}	Input Pin
5	V _{OUT}	Output Pin

●HSON-6

Pin No.	Symbol	Description
1	V _{OUT} *1	Output Pin
2	V _{OUT} *1	Output Pin
3	ADJ	ADJUST Pin (R1173D001x)
	NC	No Connection (R1173Dxx1x)
4	GND	Ground Pin
5	CE	Chip Enable Pin ("H" Active)
6	V _{DD}	Input Pin

*) Tab and tab suspension leads in the  parts are GND level.

(They are connected to the reverse side of the IC.)

The tab is better to be connected to the GND, but leaving it open is also acceptable.

The tab suspension leads should be open and do not connect to other wires or land patterns.

*1) The V_{OUT} pin must be wired together when it is mounted on board.

●HSOP-6J

Pin No.	Symbol	Description
1	V _{OUT}	Output Pin
2	GND*1	Ground Pin
3	ADJ	ADJUST Pin (R1173S001x)
	NC	No Connection (R1173Sxx1x)
4	CE	Chip Enable Pin ("H" Active)
5	GND*1	Ground Pin
6	V _{DD}	Input Pin

*1) The GND pin must be wired together when it is mounted on board.

ABSOLUTE MAXIMUM RATINGS

Symbol	Item	Rating	Unit
V _{IN}	Input Voltage	6.5	V
V _{CE}	Input Voltage (CE Input Pin)	-0.3 to 6.5	V
V _{OUT}	Output Voltage	-0.3 to V _{IN} +0.3	V
P _D	Power Dissipation (SOT-89-5)*	900	mW
	Power Dissipation (HSOP-6)*	900	
	Power Dissipation (HSOP-6J)*	1700	
T _{opt}	Operating Temperature	-40 to 85	°C
T _{stg}	Storage Temperature	-55 to 125	°C

*) For Power Dissipation, please refer to PACKAGE INFORMATION.

ABSOLUTE MAXIMUM RATINGS

Electronic and mechanical stress momentarily exceeded absolute maximum ratings may cause the permanent damages and may degrade the life time and safety for both device and system using the device in the field.

The functional operation at or over these absolute maximum ratings is not assured.

RECOMMENDED OPERATING CONDITIONS (ELECTRICAL CHARACTERISTICS)

All of electronic equipment should be designed that the mounted semiconductor devices operate within the recommended operating conditions. The semiconductor devices cannot operate normally over the recommended operating conditions, even if when they are used over such conditions by momentary electronic noise or surge. And the semiconductor devices may receive serious damage when they continue to operate over the recommended operating conditions.

ELECTRICAL CHARACTERISTICS

• R1173xxxxB/D (Fixed Output Voltage Type)

T_{opt}=25°C

Symbol	Item	Conditions	Min.	Typ.	Max.	Unit	
V _{IN}	Input Voltage		1.4		6.0	V	
I _{SS}	Supply Current	V _{IN} -V _{OUT} =1.0V, V _{CE} =V _{IN} , I _{OUT} =0A		60	100	μA	
I _{standby}	Standby Current	V _{IN} = 6.0V, V _{CE} =0V		0.1	1.0	μA	
V _{OUT}	Output voltage	V _{IN} -V _{OUT} =1.0V I _{OUT} =100mA	V _{OUT} >1.5V	×0.98	×1.02	V	
			V _{OUT} ≤ 1.5V	-30	+30	mV	
ΔV _{OUT} / ΔI _{OUT}	Load regulation	V _{IN} -V _{OUT} =0.3V, 1mA ≤ I _{OUT} ≤ 300mA If V _{OUT} ≤ 1.1V, then V _{IN} =1.4V		-15	-2	15	mV
		V _{IN} -V _{OUT} =0.3V, 1mA ≤ I _{OUT} ≤ 1A If V _{OUT} ≤ 1.1V, then V _{IN} =1.7V			-3		
V _{DIF}	Dropout Voltage	Refer to the following table					
ΔV _{OUT} / ΔV _{IN}	Line regulation	I _{OUT} =100mA, V _{OUT} +0.5V ≤ V _{IN} ≤ 6.0V If V _{OUT} ≤ 0.9V, 1.4V ≤ V _{IN} ≤ 6.0V		0.05	0.20	%/V	
RR	Ripple Rejection	f=1kHz (V _{OUT} ≤ 4.0V) f=1kHz (V _{OUT} >4.0V) Ripple 0.5Vp-p, V _{IN} -V _{OUT} =1.0V, I _{OUT} =100mA If V _{OUT} ≤ 1.2V, V _{IN} -V _{OUT} =1.5V, I _{OUT} =100mA		70 60		dB	
ΔV _{OUT} / ΔT _{opt}	Output Voltage Temperature Coefficient	I _{OUT} =100mA, -40°C ≤ T _{opt} ≤ 85°C		±100		ppm/ °C	
I _{LIM}	Output Current	V _{IN} -V _{OUT} =1.0V	1			A	
I _{SC}	Short Current Limit	V _{OUT} =0V		250		mA	
R _{PD}	Pull-down resistance for CE pin		1.9	5.0	15.0	MΩ	
V _{CEH}	CE Input Voltage "H"		1.0		6.0	V	
V _{CEL}	CE Input Voltage "L"		0		0.4	V	
T _{TSD}	Thermal Shutdown Detector Threshold Temperature	Junction Temperature		150		°C	
T _{TSR}	Thermal Shutdown Released Temperature	Junction Temperature		120		°C	
en	Output Noise	BW=10Hz to 100kHz		30		μVrms	

• Dropout Voltage by Output Voltage

T_{opt}=25°C

Output Voltage V _{OUT} (V)	Dropout Voltage V _{DIF} (V)		
	I _{OUT} =300mA		I _{OUT} =1A
	Typ.	Max.	Typ.
0.8 ≤ V _{OUT} < 0.9	0.33	0.57	0.72
0.9 ≤ V _{OUT} < 1.0	0.22	0.47	0.64
1.0 ≤ V _{OUT} < 1.5	0.18	0.32	0.56
1.5 ≤ V _{OUT} < 2.6	0.10	0.15	0.32
2.6 ≤ V _{OUT}	0.05	0.10	0.18

• R1173x001B/D (Adjustable Output Voltage Type)

T_{opt}=25°C

Symbol	Item	Conditions	Min.	Typ.	Max.	Unit
V _{IN}	Input Voltage		1.4		6.0	V
I _{SS}	Supply Current	V _{OUT} =V _{ADJ} , V _{IN} =2.0, V _{CE} =V _{IN}		60	100	μA
I _{standby}	Standby Current	V _{IN} =6.0V, V _{CE} =0V		0.1	1.0	μA
V _{OUT}	Reference Voltage for Adjustable Voltage Regulator	V _{OUT} =V _{ADJ} , V _{IN} =2.0V I _{OUT} =100mA	0.970	1.000	1.030	V
RV _{OUT}	Output Voltage Range		1.0		V _{IN}	V
ΔV _{OUT} / ΔI _{OUT}	Load regulation	V _{IN} =1.4V 1mA ≤ I _{OUT} ≤ 300mA	-15	-2	15	mV
		V _{IN} =1.7V 1mA ≤ I _{OUT} ≤ 1A		-3		
V _{DIF}	Dropout Voltage	V _{OUT} =V _{ADJ} I _{OUT} =300mA		0.18	0.32	V
			I _{OUT} =1A		0.56	
ΔV _{OUT} / ΔV _{IN}	Line regulation	V _{OUT} =V _{ADJ} , I _{OUT} =100mA 1.5V ≤ V _{IN} ≤ 6.0V		0.05	0.20	%/V
RR	Ripple Rejection	f=1kHz Ripple 0.5Vp-p, V _{OUT} =V _{ADJ} , V _{IN} =2.5V I _{OUT} =100mA		70		dB
ΔV _{OUT} / ΔT _{opt}	Output Voltage Temperature Coefficient	I _{OUT} =100mA -40°C ≤ T _{opt} ≤ 85°C		±100		ppm/°C
I _{LIM}	Output Current	V _{OUT} =V _{ADJ} , V _{IN} =2.0	1			A
I _{SC}	Short Current Limit	V _{OUT} =V _{ADJ} =0V		250		mA
R _{PD}	Pull-down resistance for CE pin		1.9	5.0	15.0	MΩ
V _{CEH}	CE Input Voltage "H"		1.0		6.0	V
V _{CEL}	CE Input Voltage "L"		0		0.4	V
T _{TSD}	Thermal Shutdown Detector Threshold Temperature	Junction Temperature		150		°C
T _{TSR}	Thermal Shutdown Released Temperature	Junction Temperature		120		°C
en	Output Noise	BW=10Hz to 100kHz		30		μVrms

Technical Notes on External Components and Typical Application

(Refer to the example of typical application)

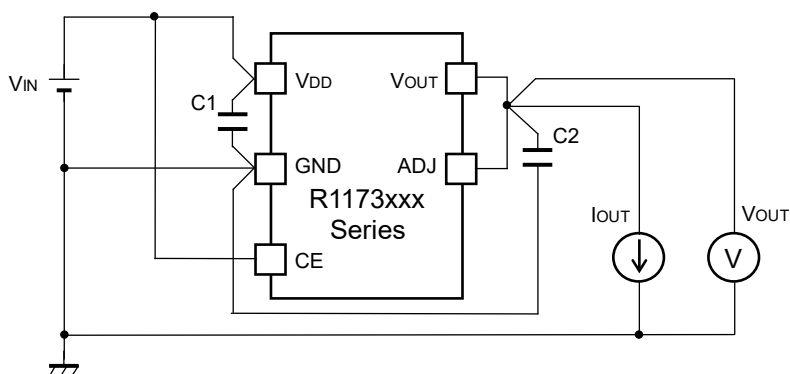

Example of the typical application of R1173x (Fixed Output Type)

Phase Compensation

In these ICs, phase compensation is made with the output capacitor for securing stable operation even if the load current is varied. For this purpose, use as much as a capacitor as C2. Recommendation value is as follows:

Mounting on PCB

Make V_{DD} and GND lines sufficient. If their impedance is high, a current flows, the noise picked up or unstable operation may result. Further use a $4.7\mu\text{F}$ or more value capacitor between V_{DD} pin and GND pin as close as possible.

Set an Output capacitor between V_{OUT} pin and GND pin for phase compensation as close as possible.

Output Voltage	C2 recommendation value	Components Recommendation	
$V_{OUT} < 1.0\text{V}$	Tantalum $4.7\mu\text{F}$ or more		
$1.0 \leq V_{OUT} < 3.3\text{V}$	Ceramic $4.7\mu\text{F}$ or more	Kyocera $4.7\mu\text{F}$ (1608) Murata $4.7\mu\text{F}$ (1608) Murata $10\mu\text{F}$ (1608)	Part Number: CM105X5R475M06AB Part Number: GRM188R60J475KE19B Part Number: GRM188B30G106ME46B
$3.3\text{V} \leq V_{OUT}$	Ceramic $4.7\mu\text{F}$ or more	Kyocera $4.7\mu\text{F}$ (thin 2012) Murata $10\mu\text{F}$ (1608)	Part Number: CT21X5R475M06AB Part Number: GRM188B30G106ME46B

If you use a tantalum type capacitor and ESR value of the capacitor is large, output might be unstable. Evaluate your circuit with considering frequency characteristics.

Depending on the capacitor size, manufacturer, and part number, the bias characteristics and temperature characteristics are different. Evaluate the circuit with actual using capacitors.

Technical Notes on Output Voltage Setting of Adjustable Output type (R1173x001x)

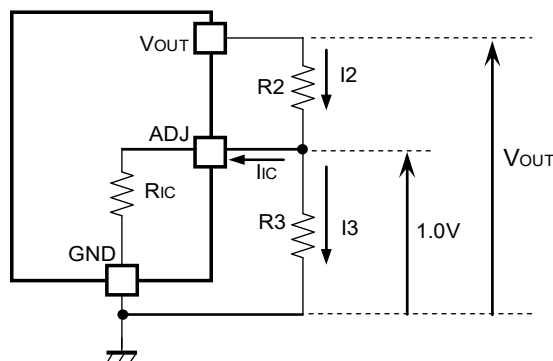

The Output Voltage may be adjustable for any output voltage between its 1.0V reference and its V_{DD} setting level. An external pair of resistors is required, as shown above.

The complete equation for the output voltage is described step by step as follows;

$$I_2 = I_{ic} + I_3 \dots\dots\dots (1)$$

$$I_3 = 1.0/R_3 \dots\dots\dots (2)$$

Thus,

$$I_2 = I_{ic} + 1.0/R_3 \dots\dots\dots (3)$$

Therefore,

$$V_{OUT} = 1.0 + R_2 \times I_2 \dots\dots\dots (4)$$

Put Equation (3) into Equation (4), then

$$\begin{aligned} V_{OUT} &= 1.0 + R_2(I_{ic} + 1.0/R_3) \\ &= 1.0(1 + R_2/R_3) + R_2 \times I_{ic} \dots\dots\dots (5) \end{aligned}$$

In 2nd term, or $R_2 \times I_{ic}$ will produce an error in V_{OUT} .

In Equation (5),

$$I_{ic} = 1.0/R_{ic} \dots\dots\dots (6)$$

$$\begin{aligned} R_2 \times I_{ic} &= R_2 \times 1.0/R_{ic} \\ &= 1.0 \times R_2/R_{ic} \dots\dots\dots (7) \end{aligned}$$

For better accuracy, choosing $R_2 \ll R_{ic}$ reduces this error.

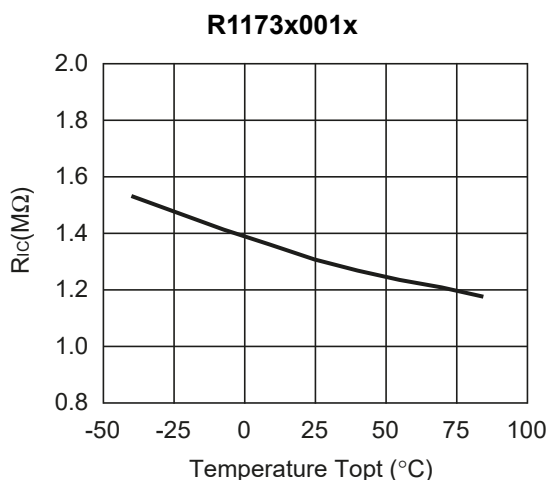

*) The graph is a typical characteristic, please evaluate the circuit with an actual condition.

TYPICAL CHARACTERISTICS

1) Output Voltage vs. Output Current (Topt=25°C)

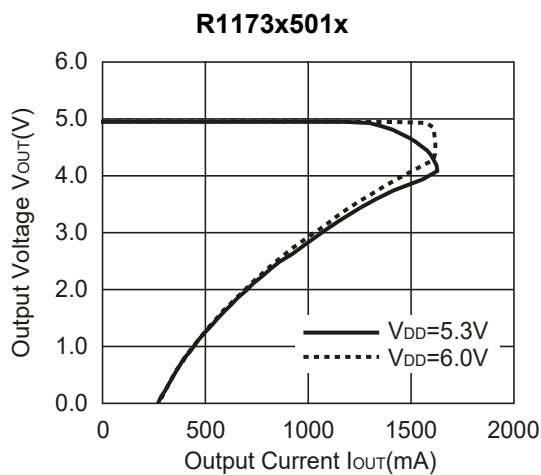
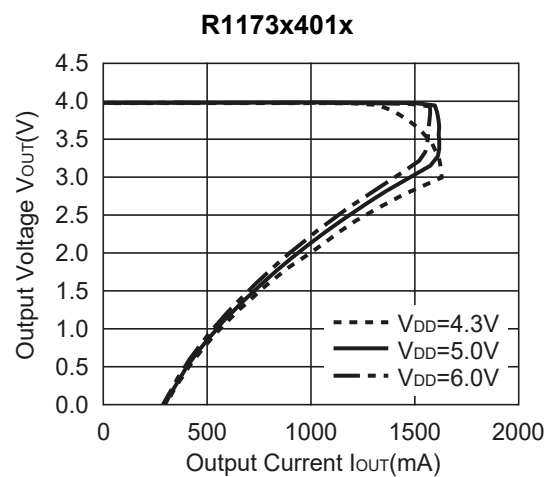
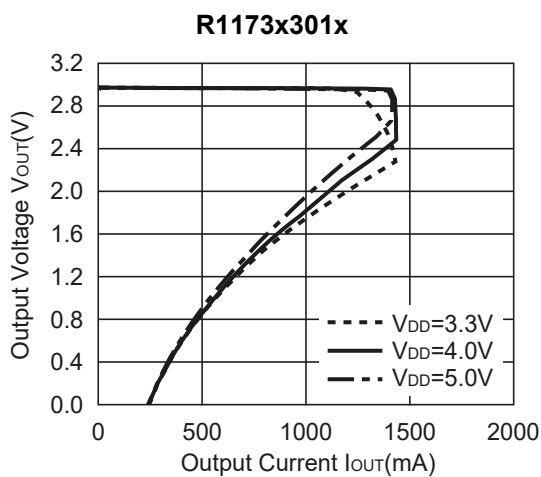
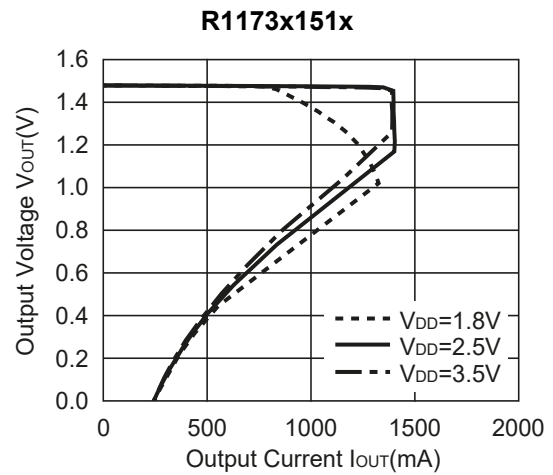
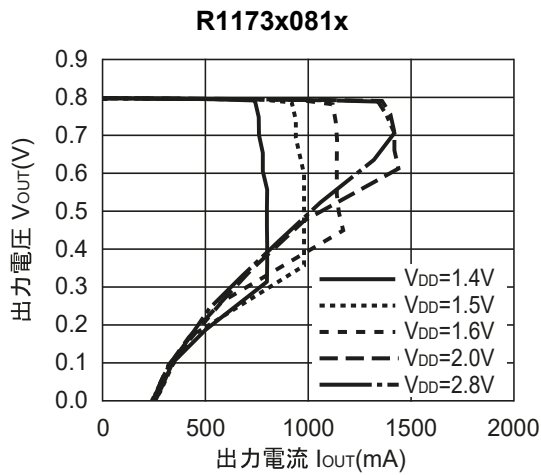

2) Output Voltage vs. Input Voltage ($T_{opt}=25^{\circ}\text{C}$)

R1173x081x

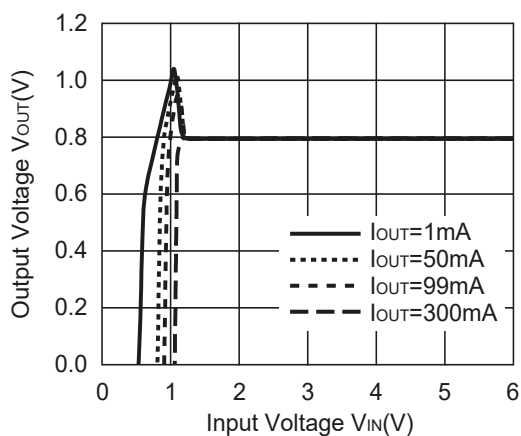

R1173x151x

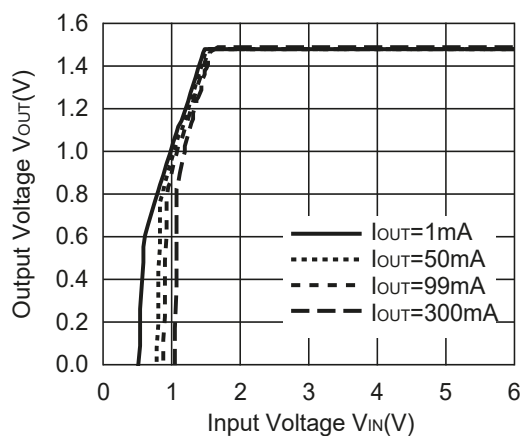

R1173x301x

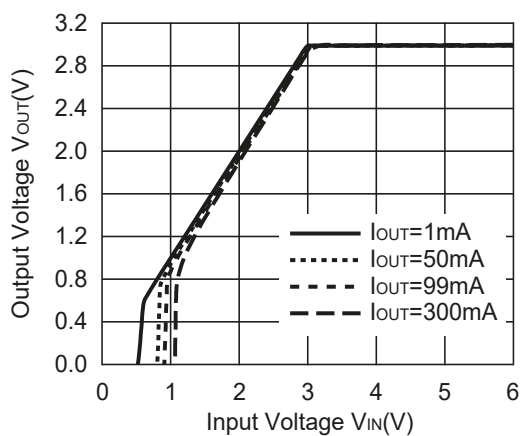

R1173x401x

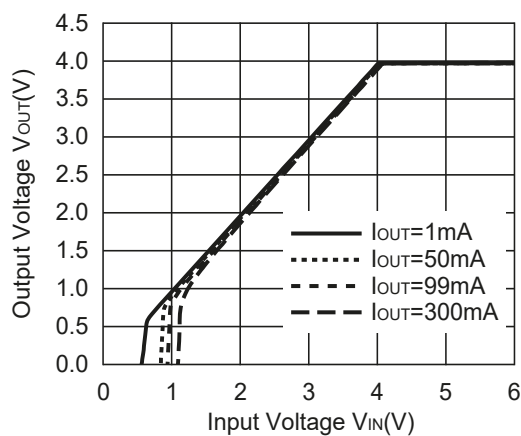

R1173x501x

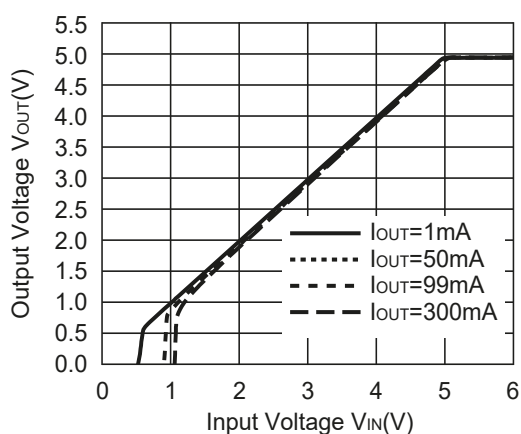

3) Dropout Voltage vs. Output Current (Topt=25°C)

R1173x081x

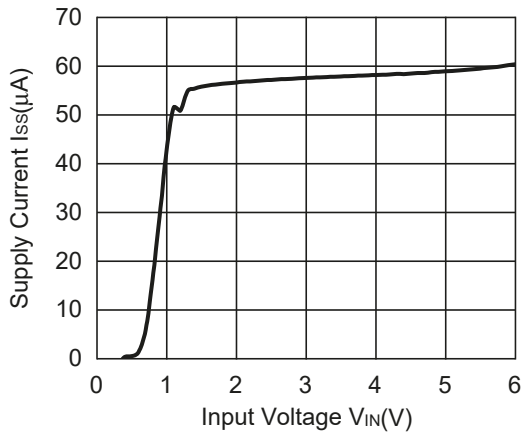

R1173x151x

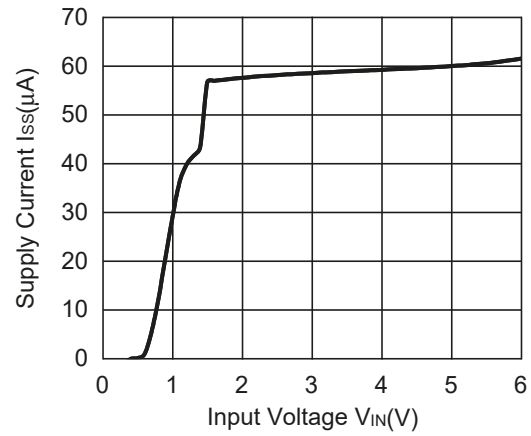

R1173x301x

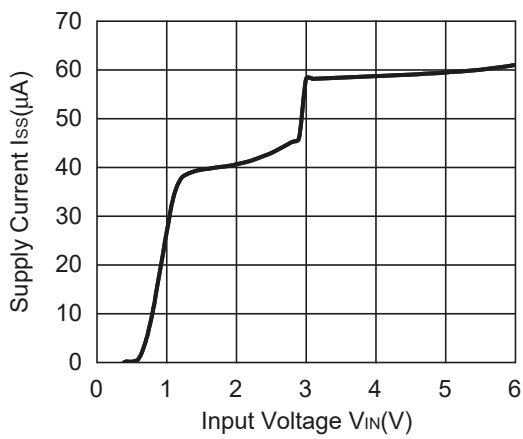

R1173x401x

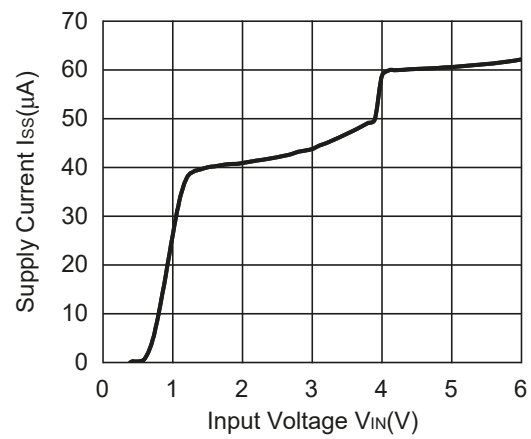

R1173x501x

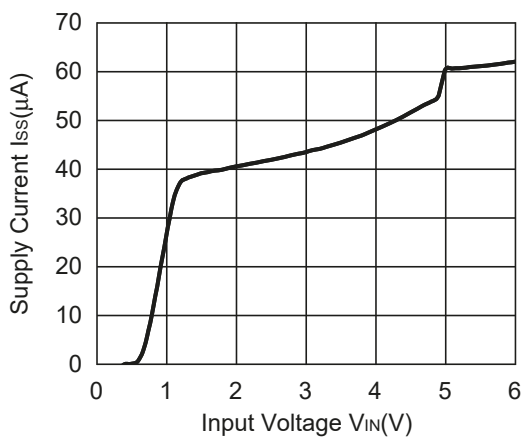

4) Output Voltage vs. Temperature ($I_{OUT}=100mA$)

R1173x081x

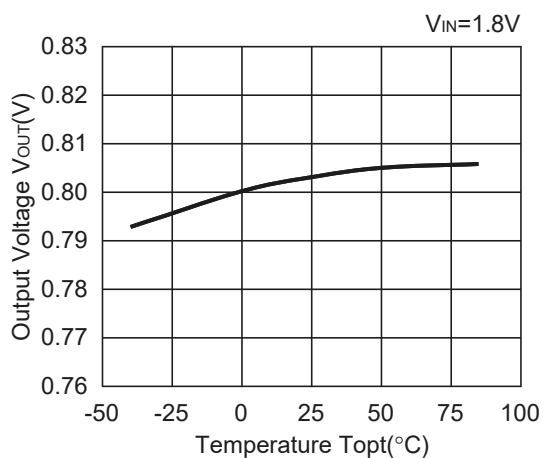

R1173x151x

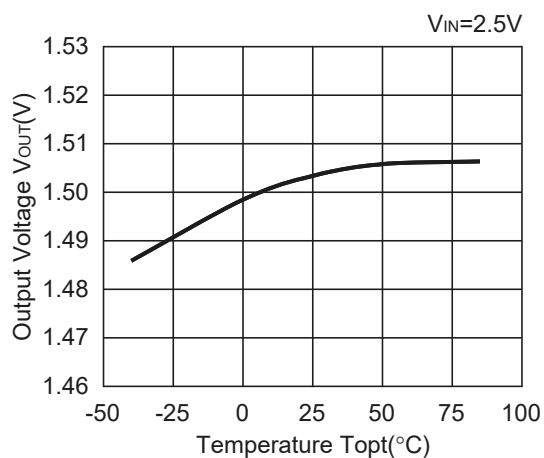

R1173x301x

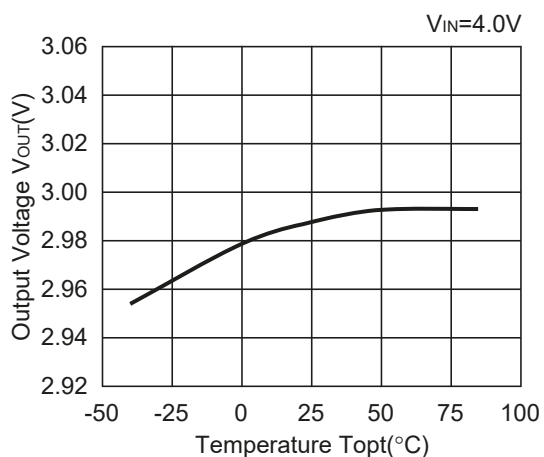

R1173x501x

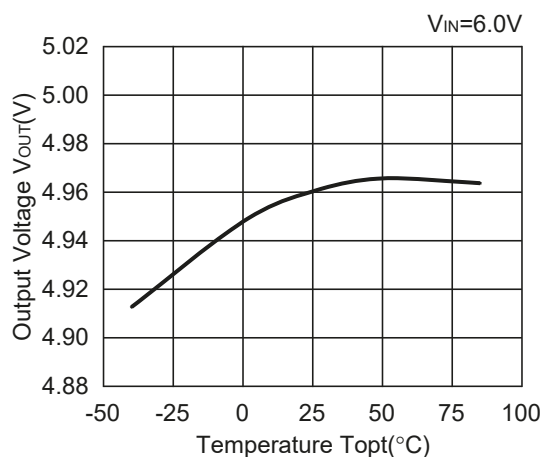

5) Supply Current vs. Temperature

R1173x081x

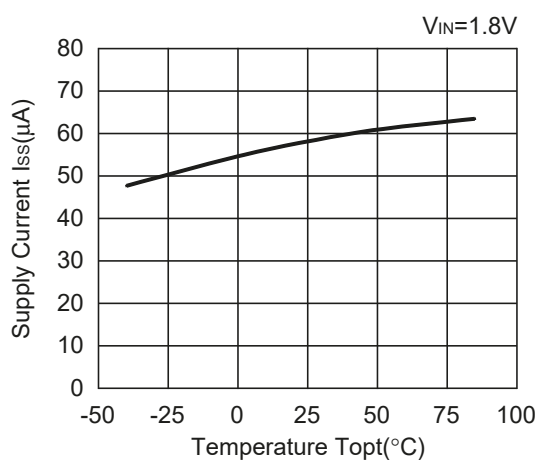

R1173x151x

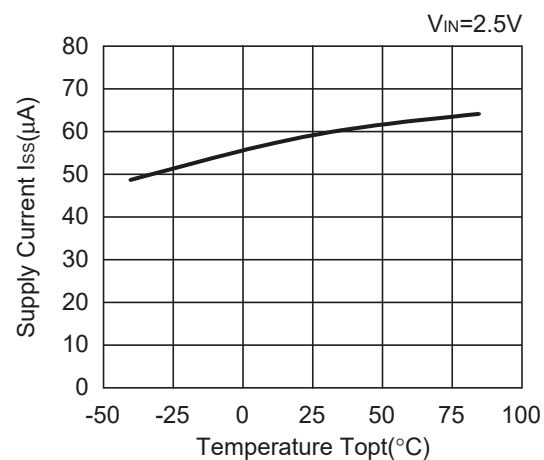

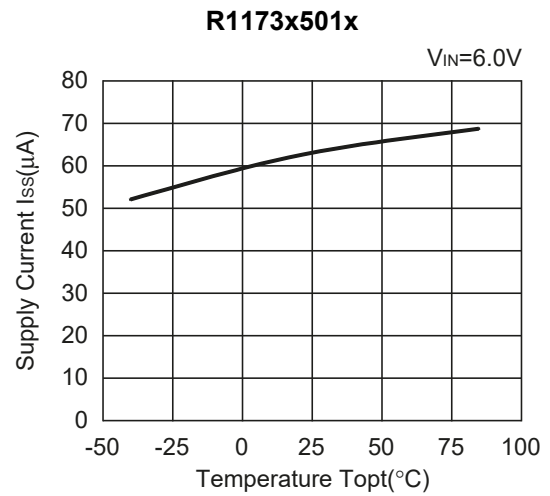
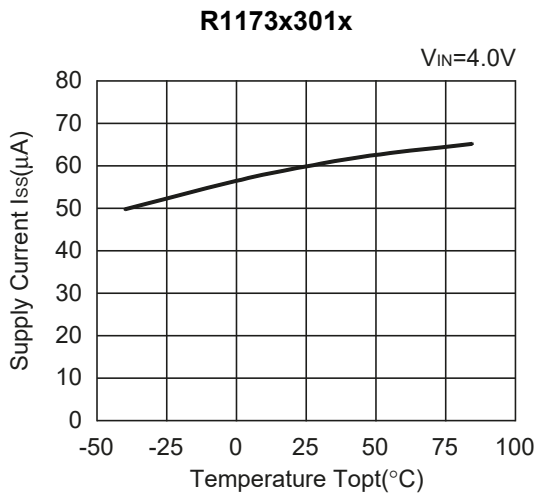

6) Dropout Voltage vs. Output Current

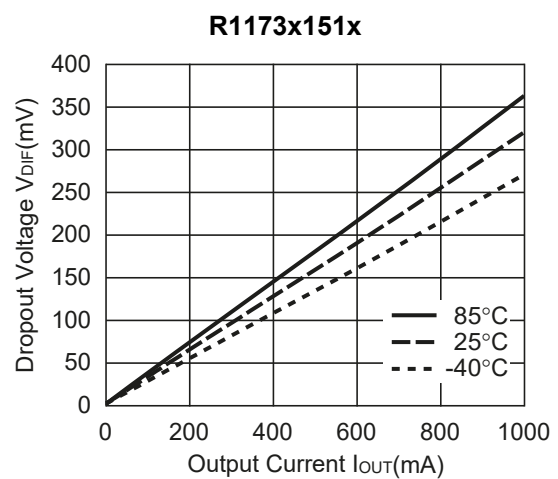
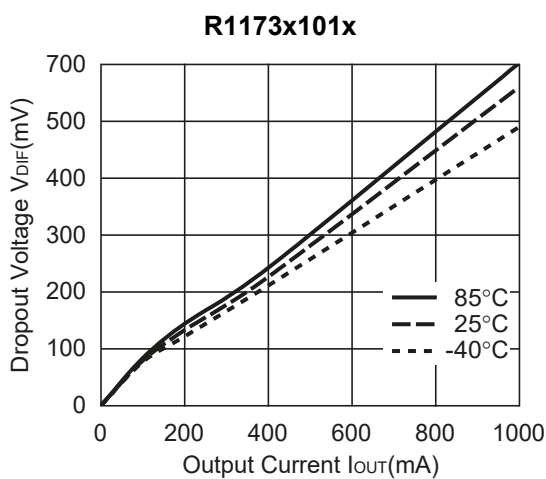
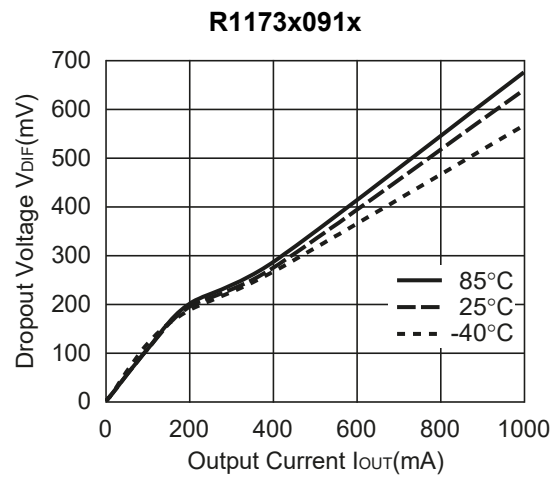
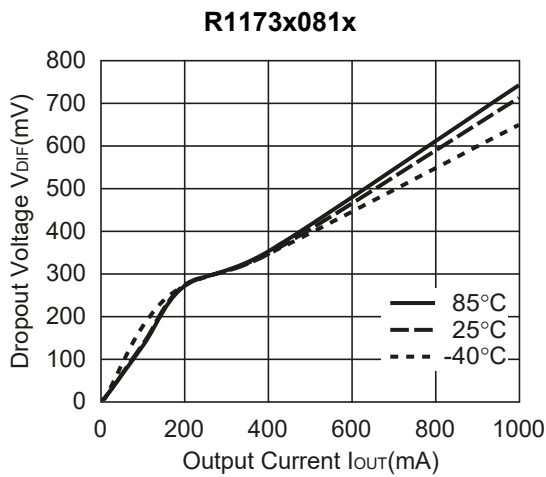

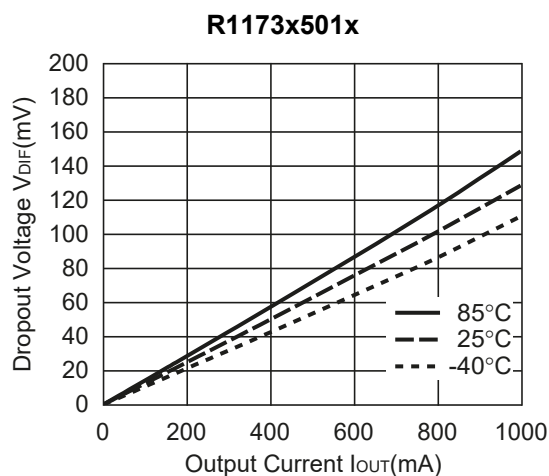
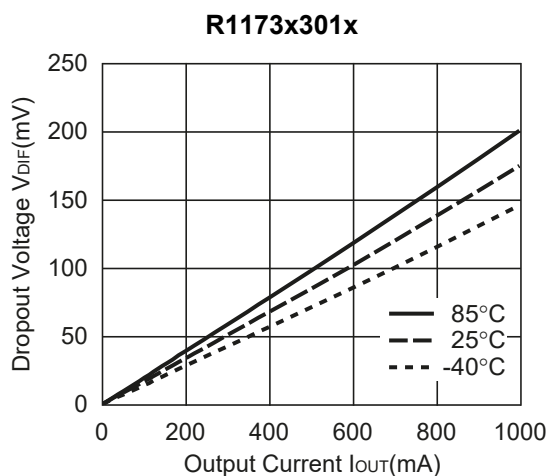

7) Dropout Voltage vs. Set Output Voltage

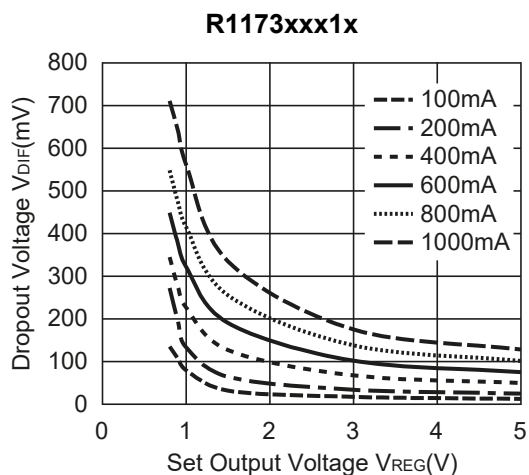

8) 0.8V Output type, Operating Input Voltage Range

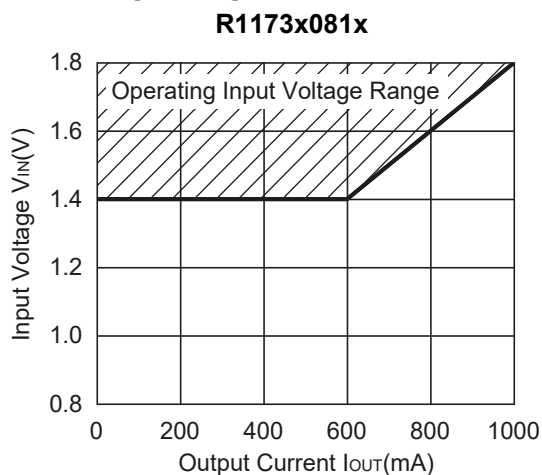

9) Ripple Rejection vs. Input Bias

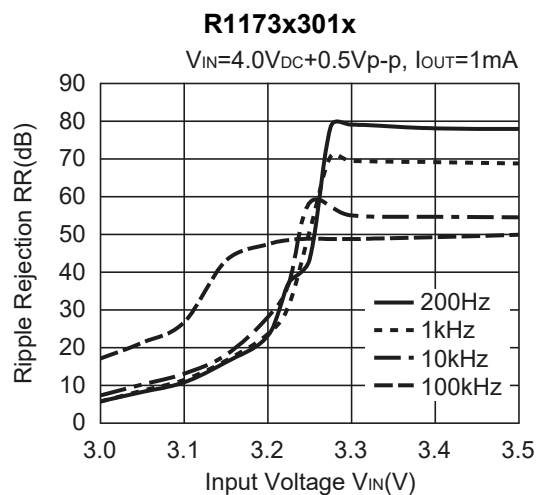
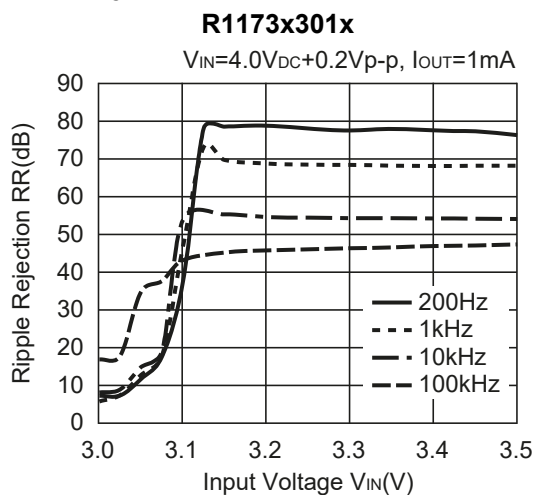

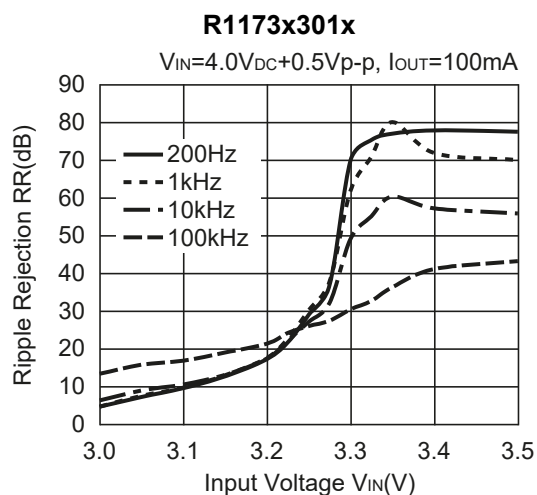
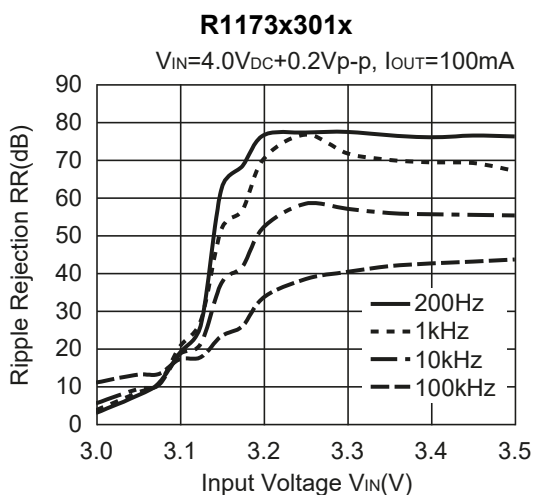
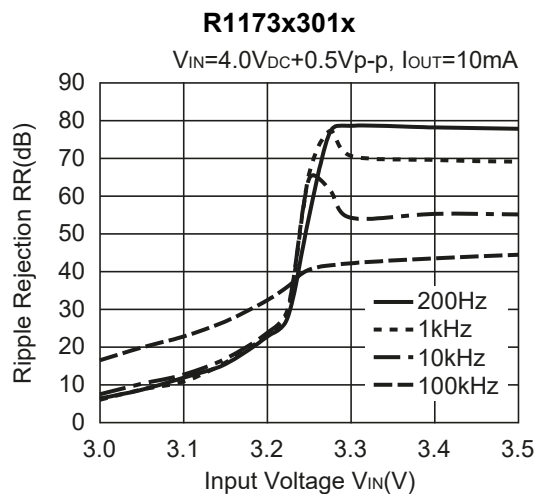
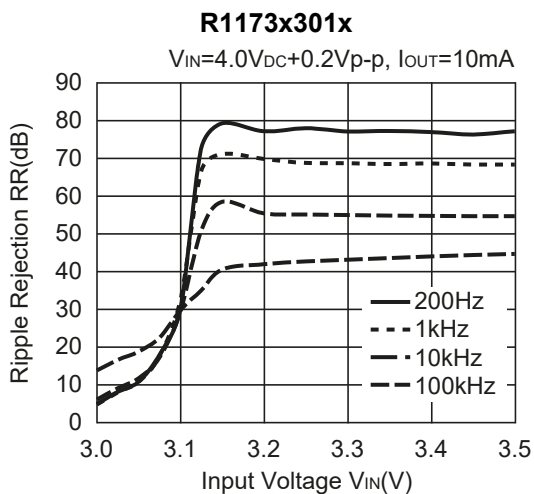

10) Ripple Rejection vs. Frequency

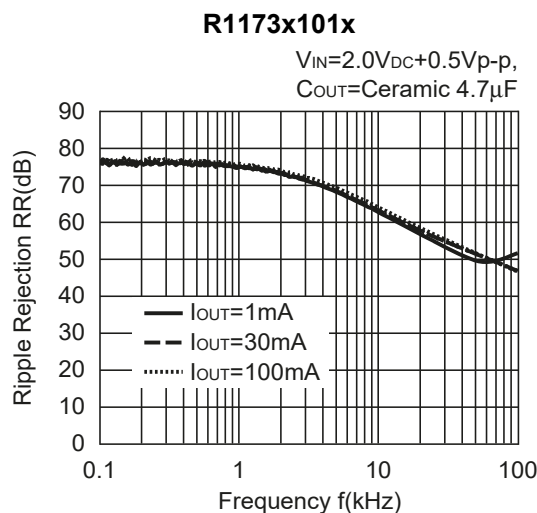
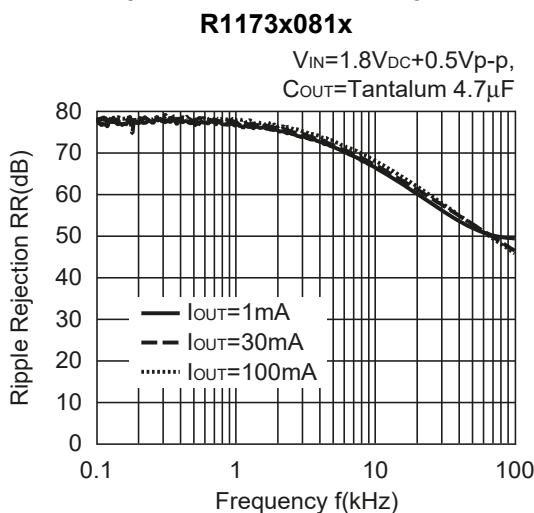

R1173x301x

$V_{IN}=4.0V_{DC}+0.5V_{p-p}$,
 $C_{OUT}=\text{Ceramic } 4.7\mu F$

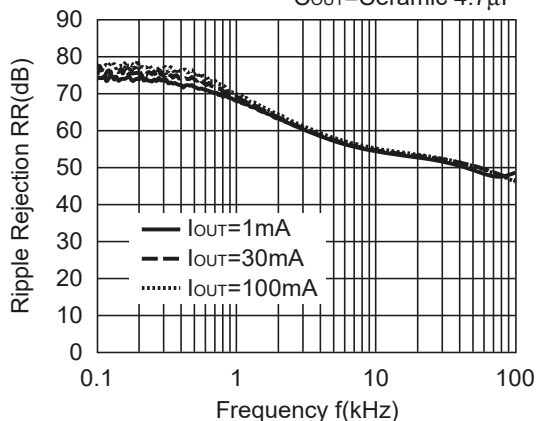

R1173x401x

$V_{IN}=5.0V_{DC}+0.5V_{p-p}$,
 $C_{OUT}=\text{Ceramic } 4.7\mu F$

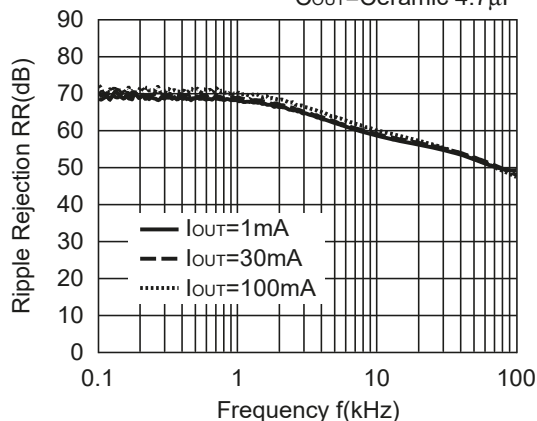

R1173x451x

$V_{IN}=5.5V_{DC}+0.5V_{p-p}$,
 $C_{OUT}=\text{Ceramic } 4.7\mu F$

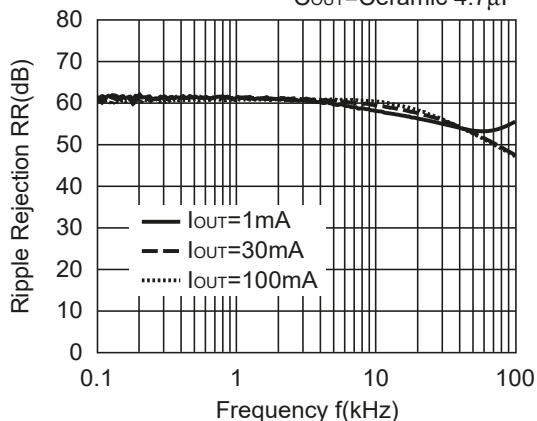

R1173x501x

$V_{IN}=6.0V_{DC}+0.5V_{p-p}$,
 $C_{OUT}=\text{Ceramic } 4.7\mu F$

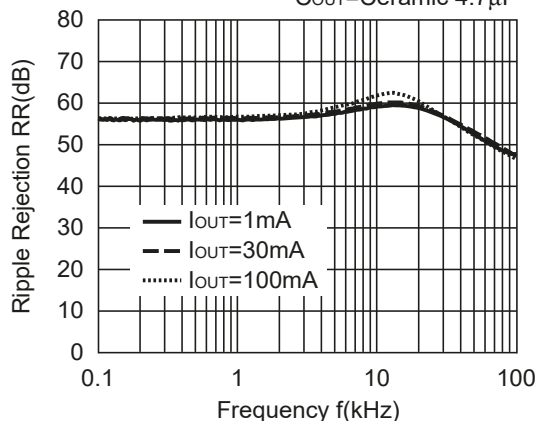

11) Line Transient Response ($T_r=T_f=5\mu s$, $I_{OUT}=100mA$)

R1173x081x

$C_{OUT}=\text{Tantalum } 4.7\mu F$

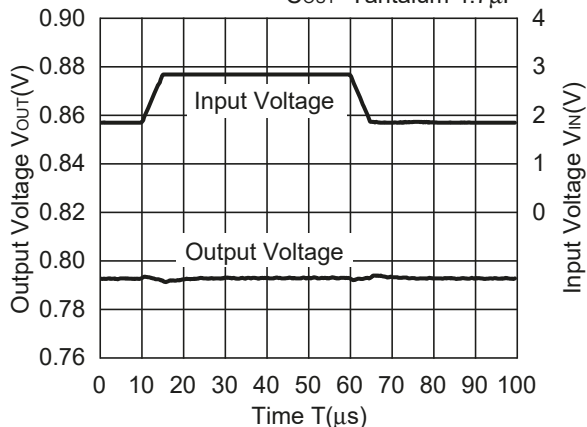

R1173x101x

$C_{OUT}=\text{Ceramic } 4.7\mu F$

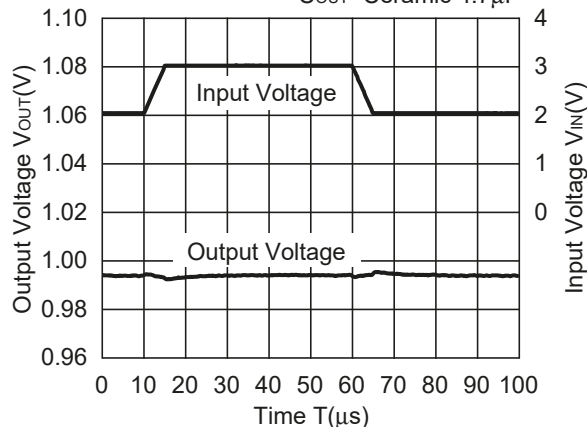

R1173x301x

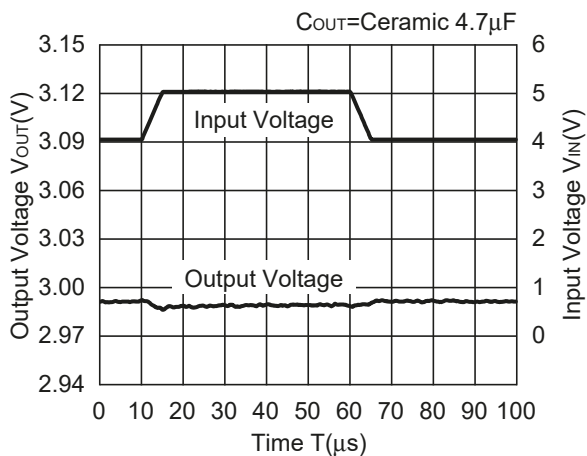

R1173x501x

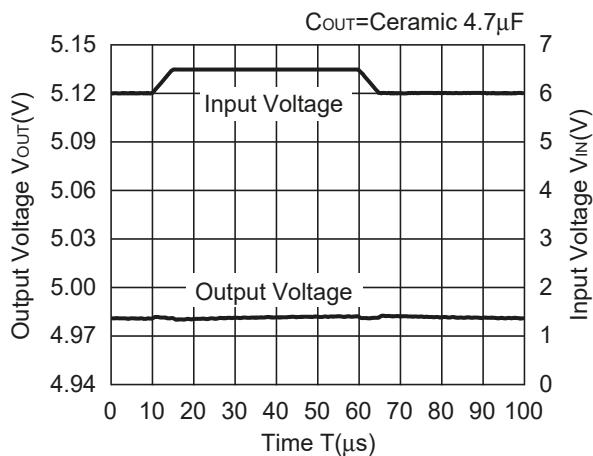

12) Load Transient Response ($T_r=T_f=500\text{ns}$)

R1173x081x

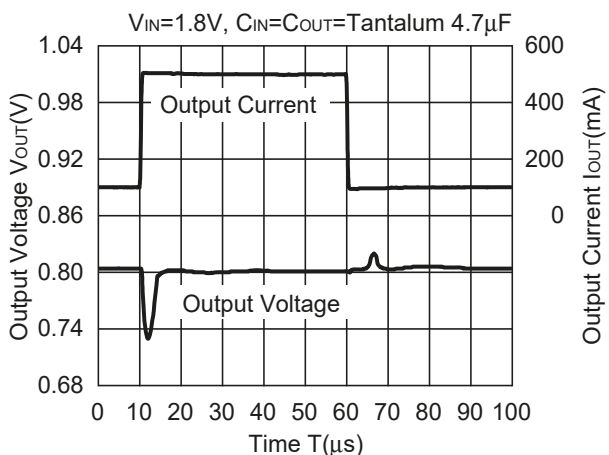

R1173x081x

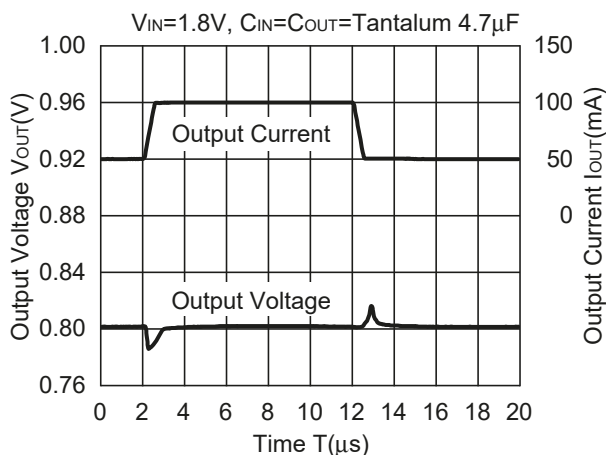

R1173x081x

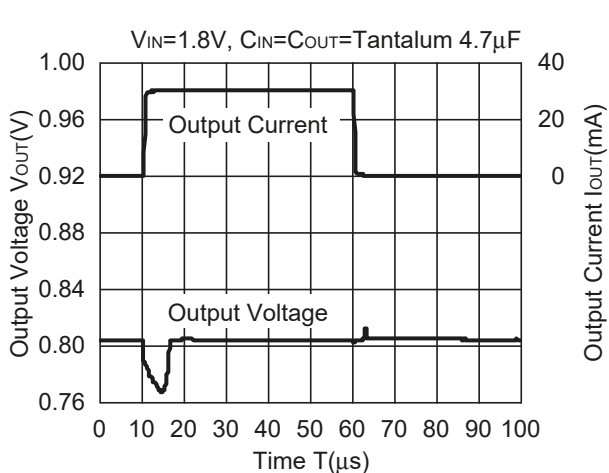

R1173x081x

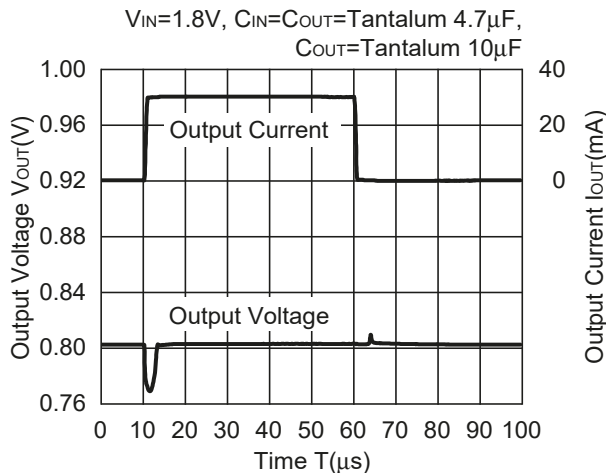

R1173x101x

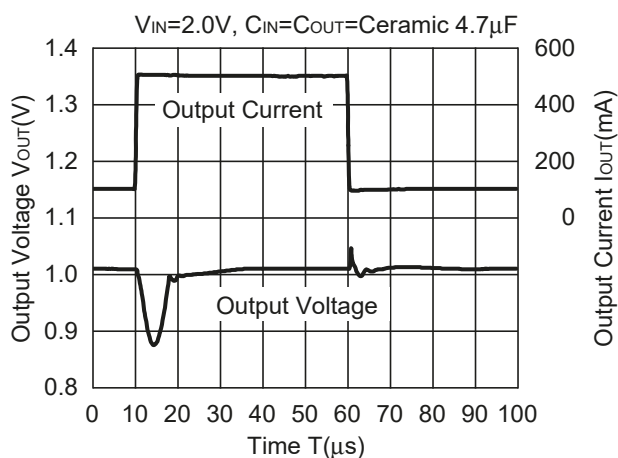

R1173x101x

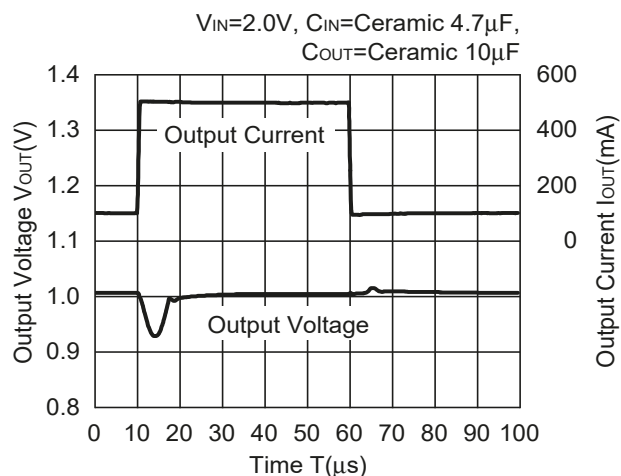

R1173x101x

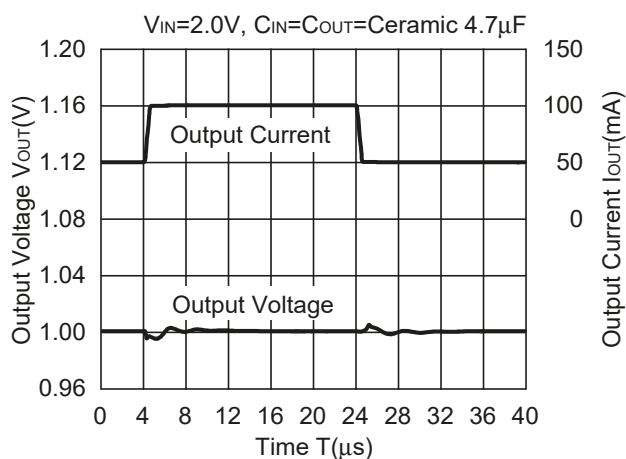

R1173x101x

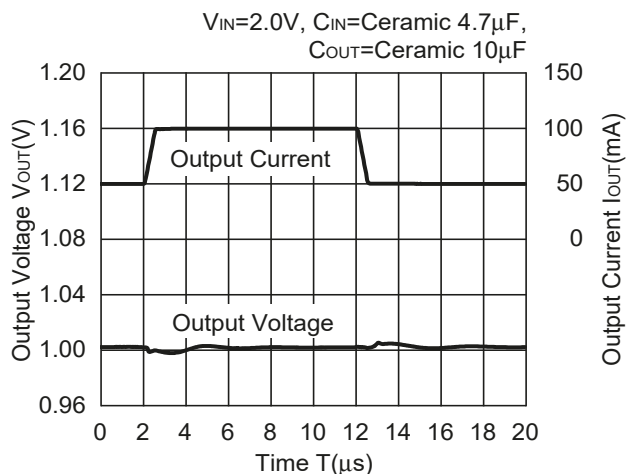

R1173x101x

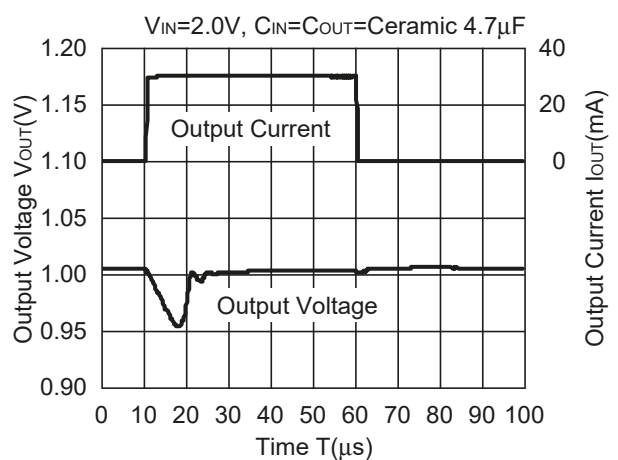

R1173x101x

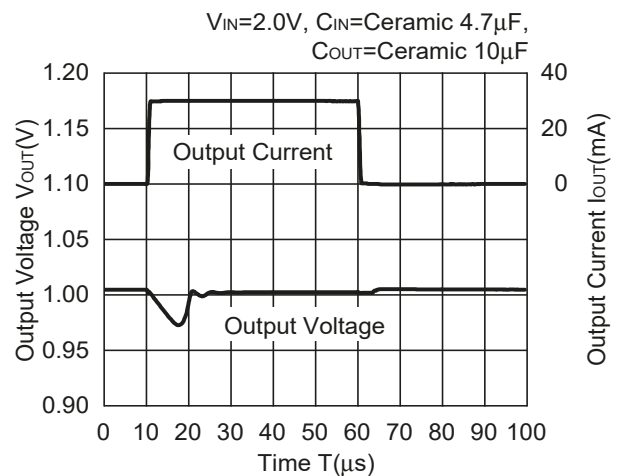

R1173x301x

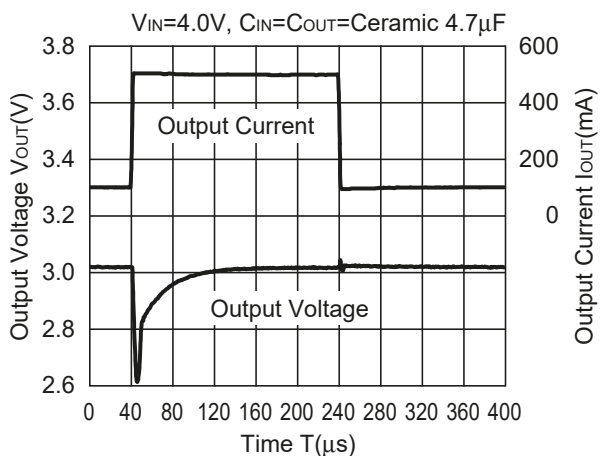

R1173x301x

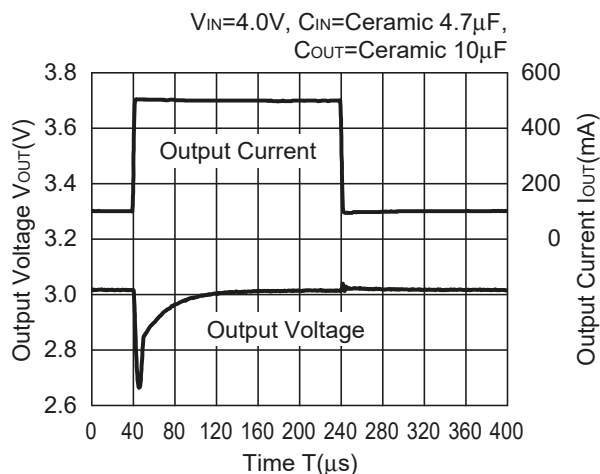

R1173x301x

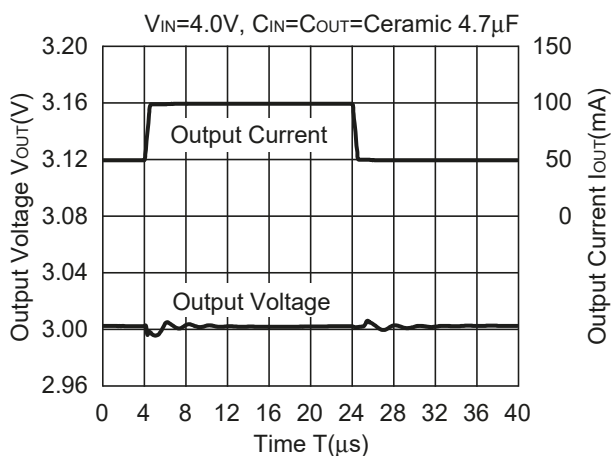

R1173x301x

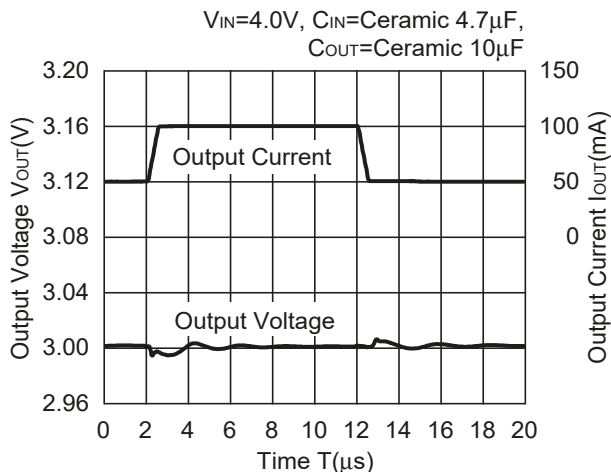

R1173x301x

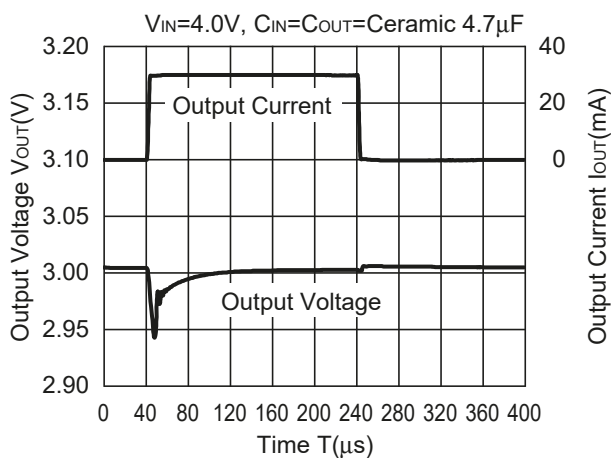

R1173x301x

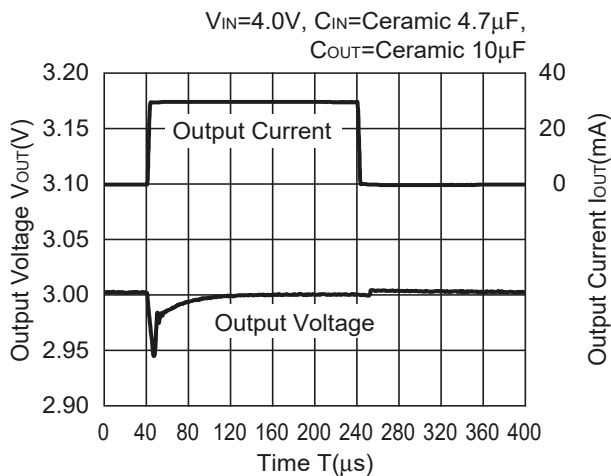

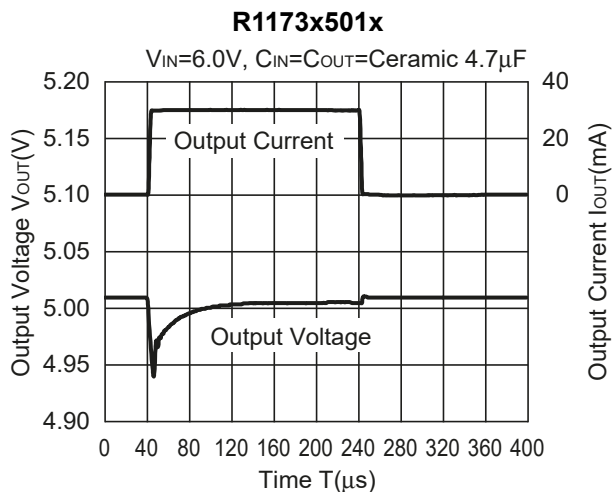
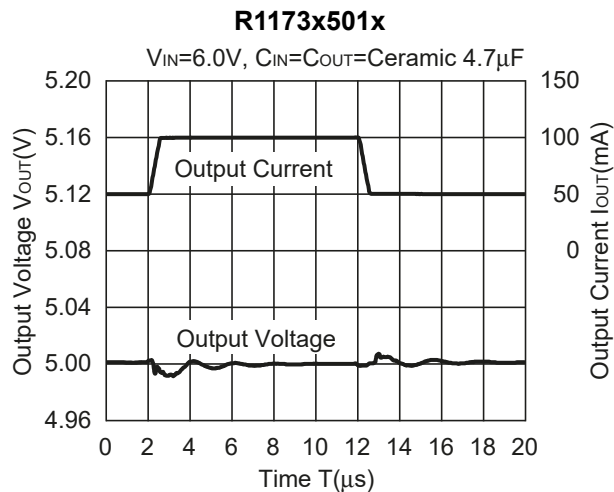
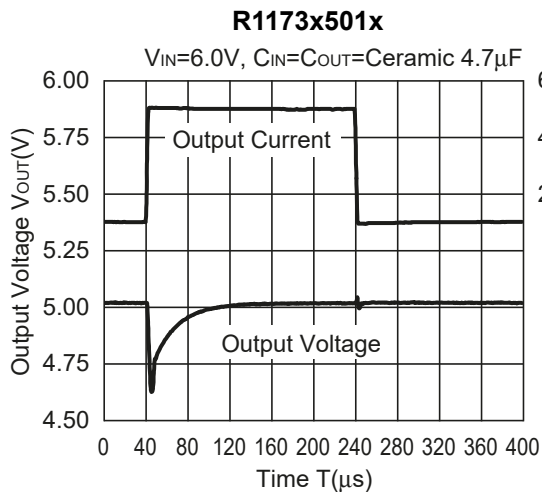

13) Turn-on speed with CE pin control

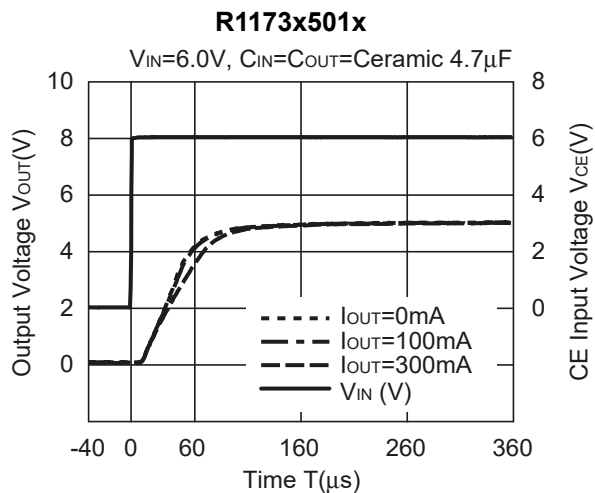
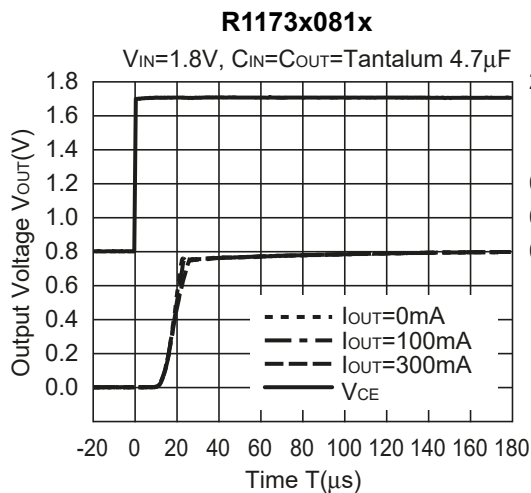

14) Turn-off speed with CE pin control

R1173x081D

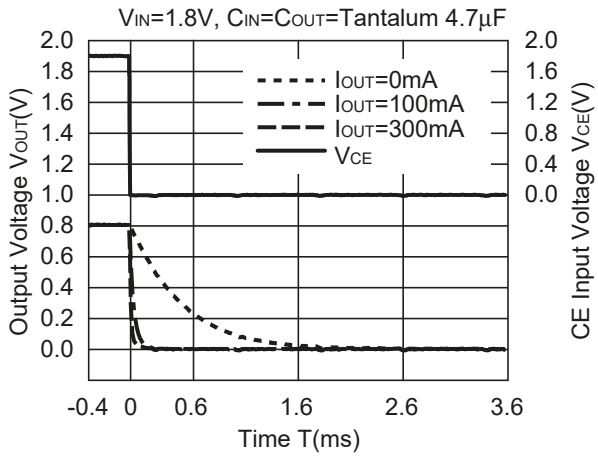

R1173x501D

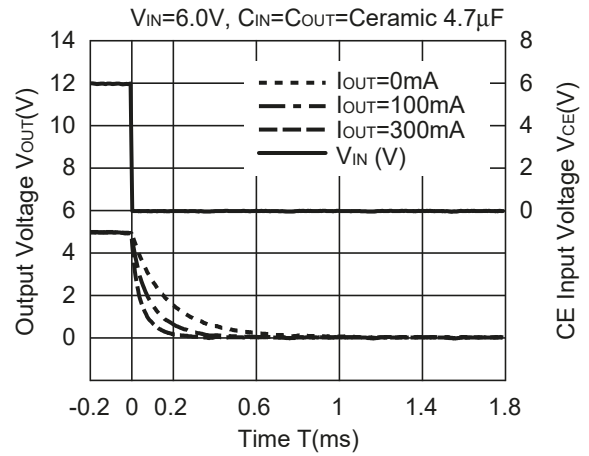

15) Inrush Current

R1173x081x

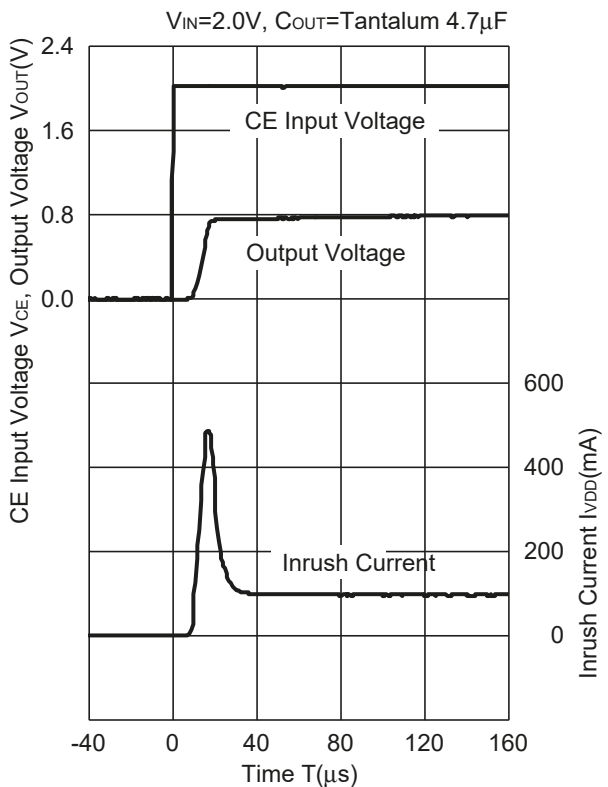

R1173x081x

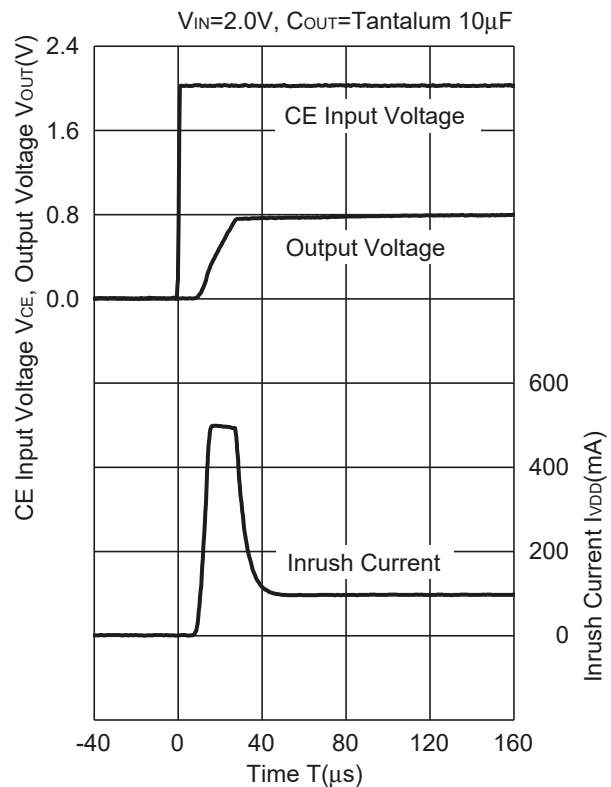

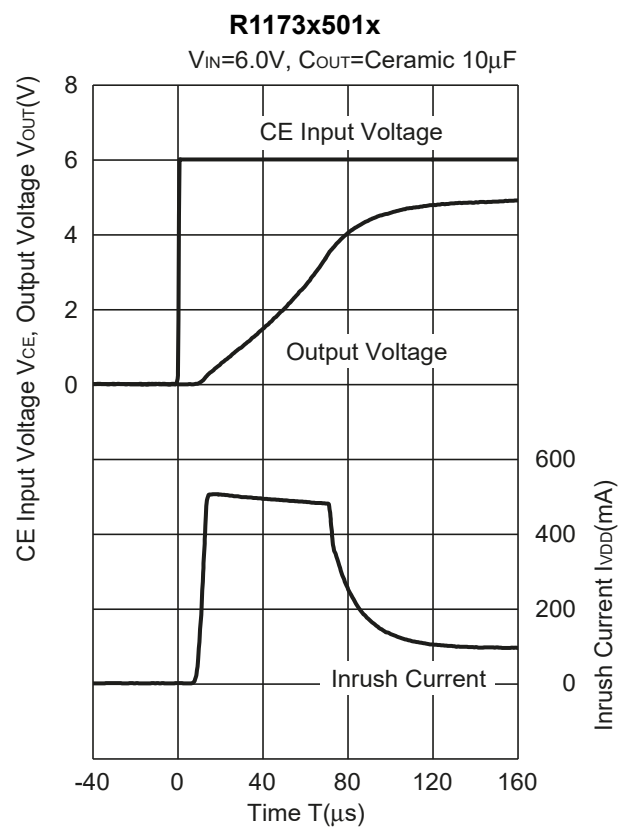
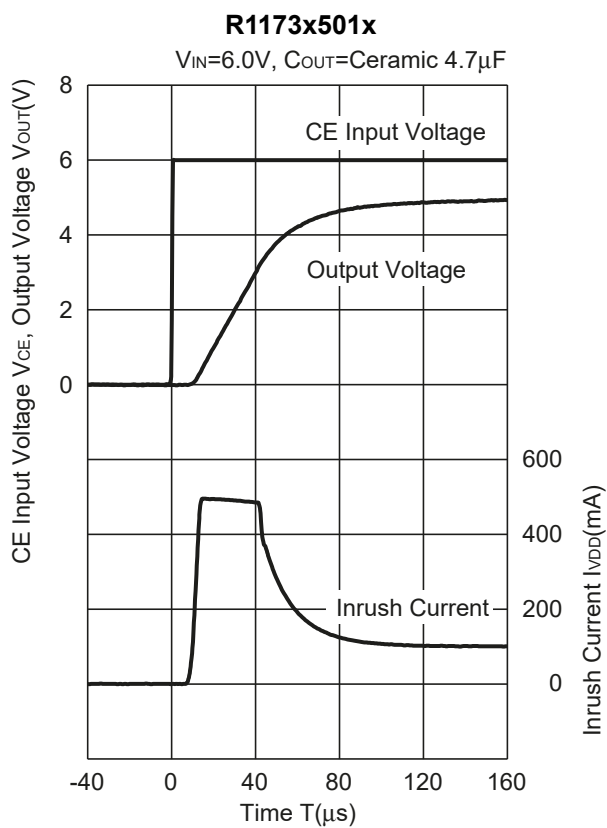
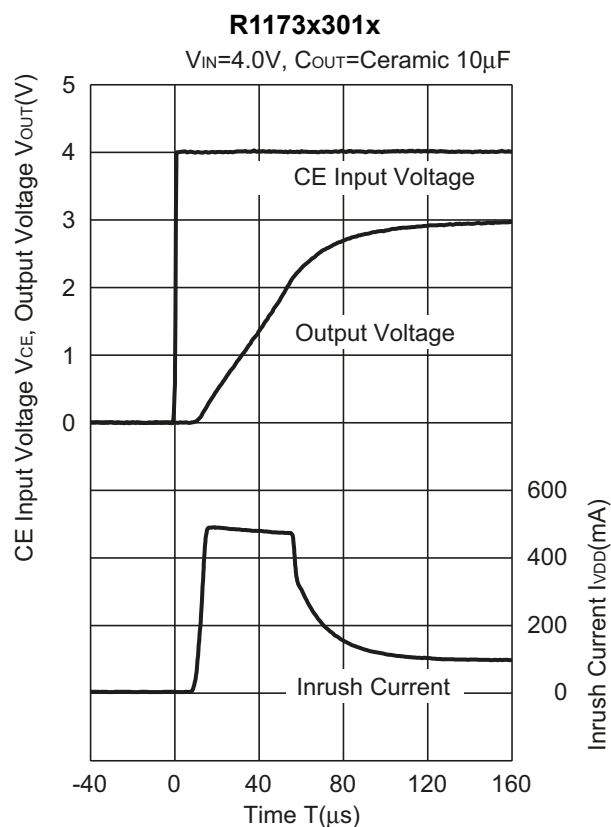
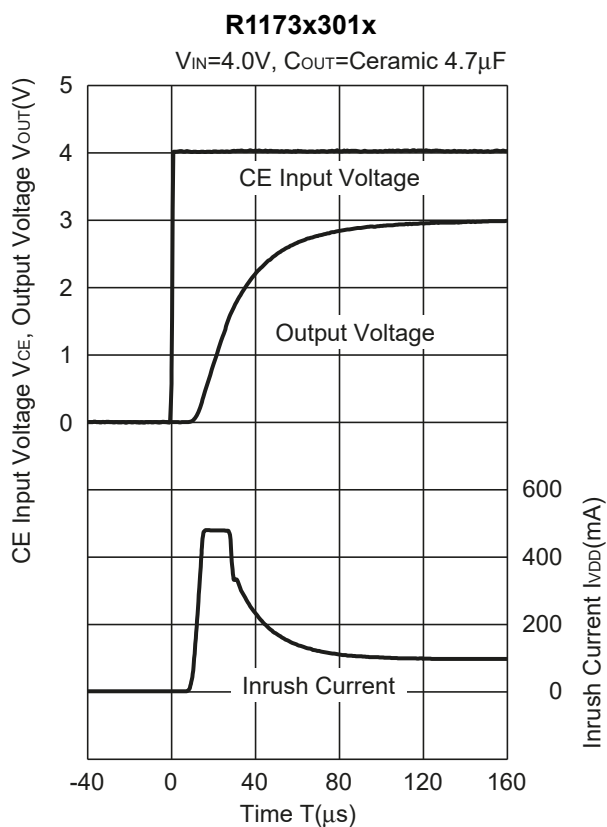

16) Stable Area: ESR limit vs. Load current

0.8V to 3.3V Output type : $C_{OUT}=4.7\mu F$ (Kyocera CM105X5R475M06AB)

5.0V Output type : $C_{OUT}=4.7\mu F$ (Kyocera CT21X5R475K06AB)

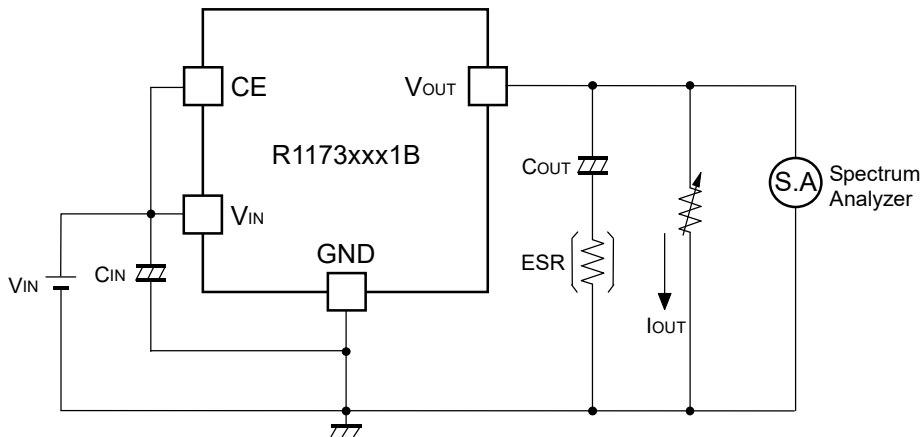

Measurement Conditions

- $V_{IN}=V_{OUT}+1V$
- Frequency=10Hz to 1MHz
- $T_{opt}=25^{\circ}C$

As an output capacitor for this IC, Ceramic capacitor is recommendable. However, other low ESR type capacitor can be used with this IC.

For your reference, noise level is tested, and if the noise level is $40\mu V$ or less than $40\mu V$, the ESR values are plotted as stable area. Upper limit is described in the next five graphs, or ESR vs. Output Current. (Hatched area is the stable area.)

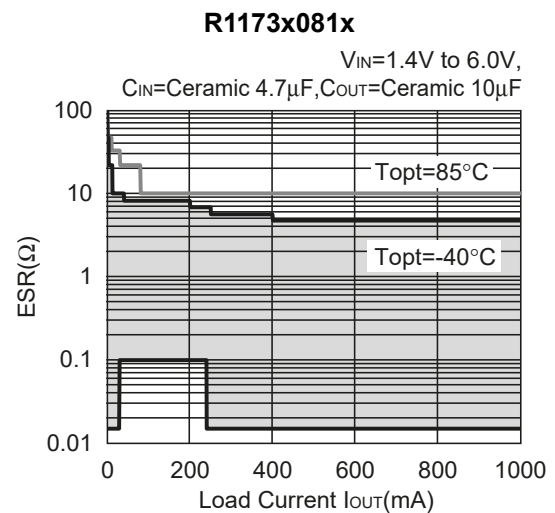
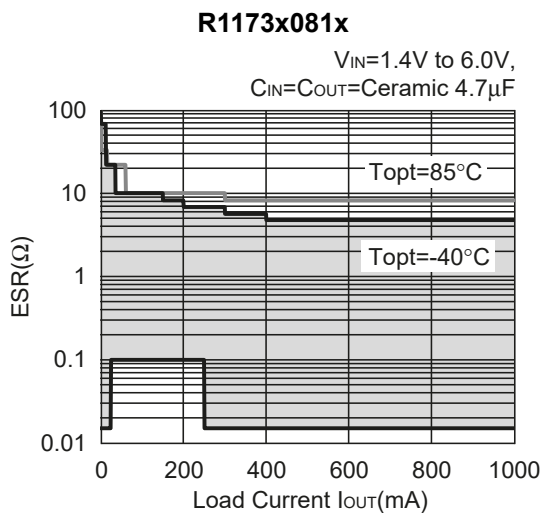

R1173x101x

$V_{IN}=1.4V$ to $6.0V$,
 $C_{IN}=C_{OUT}=\text{Ceramic } 4.7\mu F$

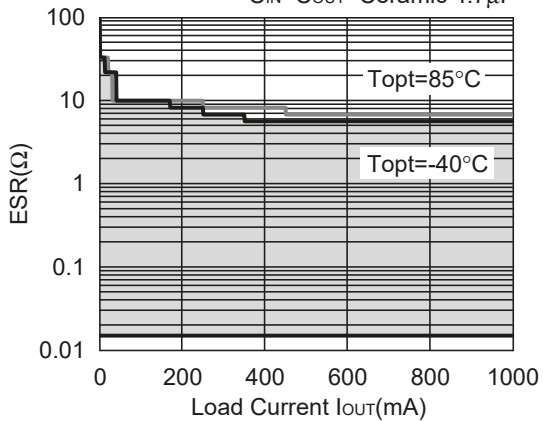

R1173x301x

$V_{IN}=3.1V$ to $6.0V$,
 $C_{IN}=C_{OUT}=\text{Ceramic } 4.7\mu F$

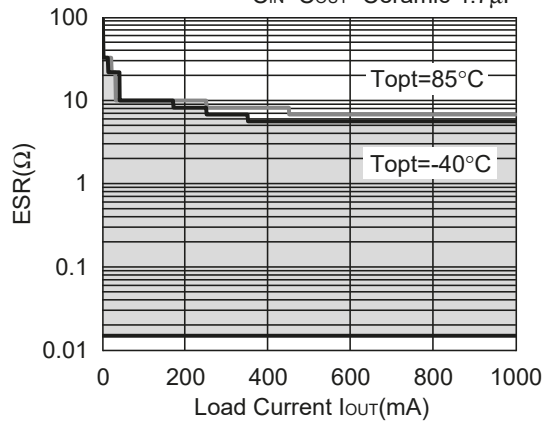

R1173x501x

$V_{IN}=3.1V$ to $6.0V$,
 $C_{IN}=C_{OUT}=\text{Ceramic } 4.7\mu F$

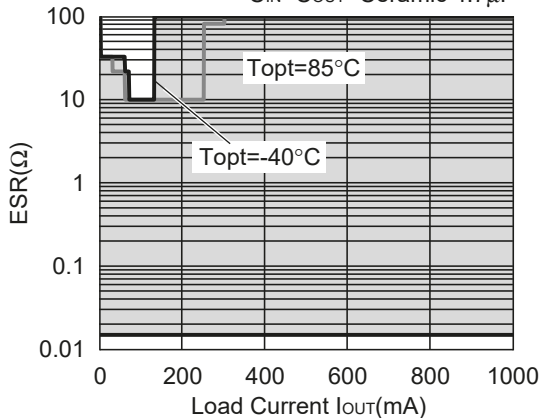

Power Dissipation (SOT-89-5)

This specification is at mounted on board. Power Dissipation (P_D) depends on conditions of mounting on board. This specification is based on the measurement at the condition below:

Measurement Conditions

	High Wattage Land Pattern	Standard Land Pattern
Environment	Mounting on Board (Wind velocity=0m/s)	Mounting on Board (Wind velocity=0m/s)
Board Material	Glass cloth epoxy plastic (Double sided)	Glass cloth epoxy plastic (Double sided)
Board Dimensions	30mm x 30mm x 1.6mm	50mm x 50mm x 1.6mm
Copper Ratio	Top side : Approx. 20% , Back side : Approx. 100%	Top side : Approx. 10% , Back side : Approx. 100%
Through-hole	$\phi 0.85\text{mm} \times 10\text{pcs}$	-

Measurement Result

($T_a=25^\circ\text{C}, T_{j\text{max}}=125^\circ\text{C}$)

	High Wattage Land Pattern	Standard Land Pattern	Free Air
Power Dissipation	1300mW	900mW	500mW
Thermal Resistance	77°C/W	111°C/W	200°C/W

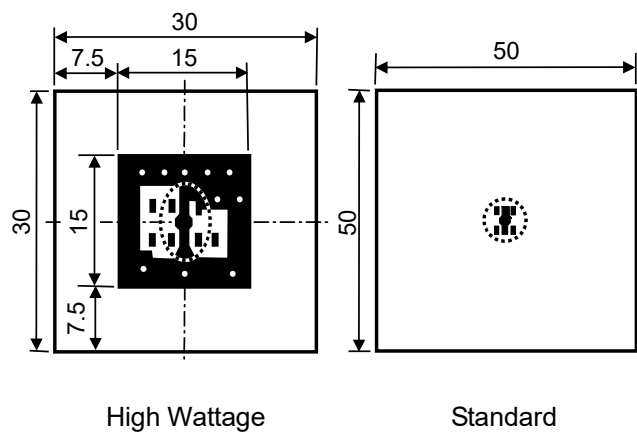
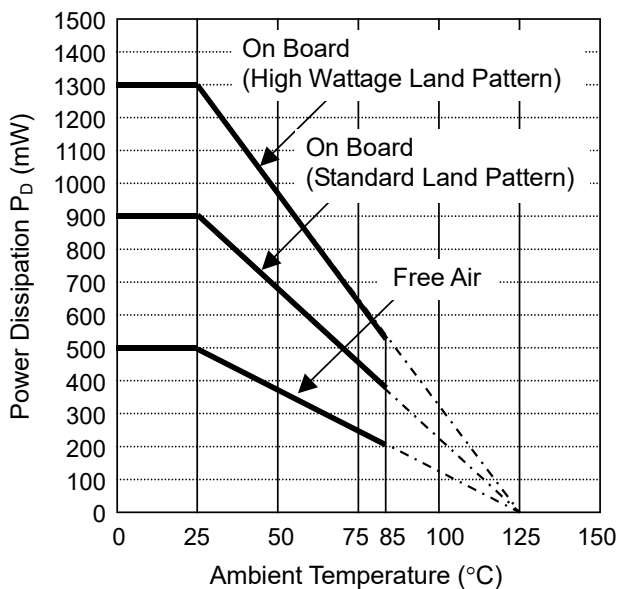

Measurement Board Pattern

IC Mount Area Unit : mm

Power Dissipation

Package Dimensions (SOT-89-5)

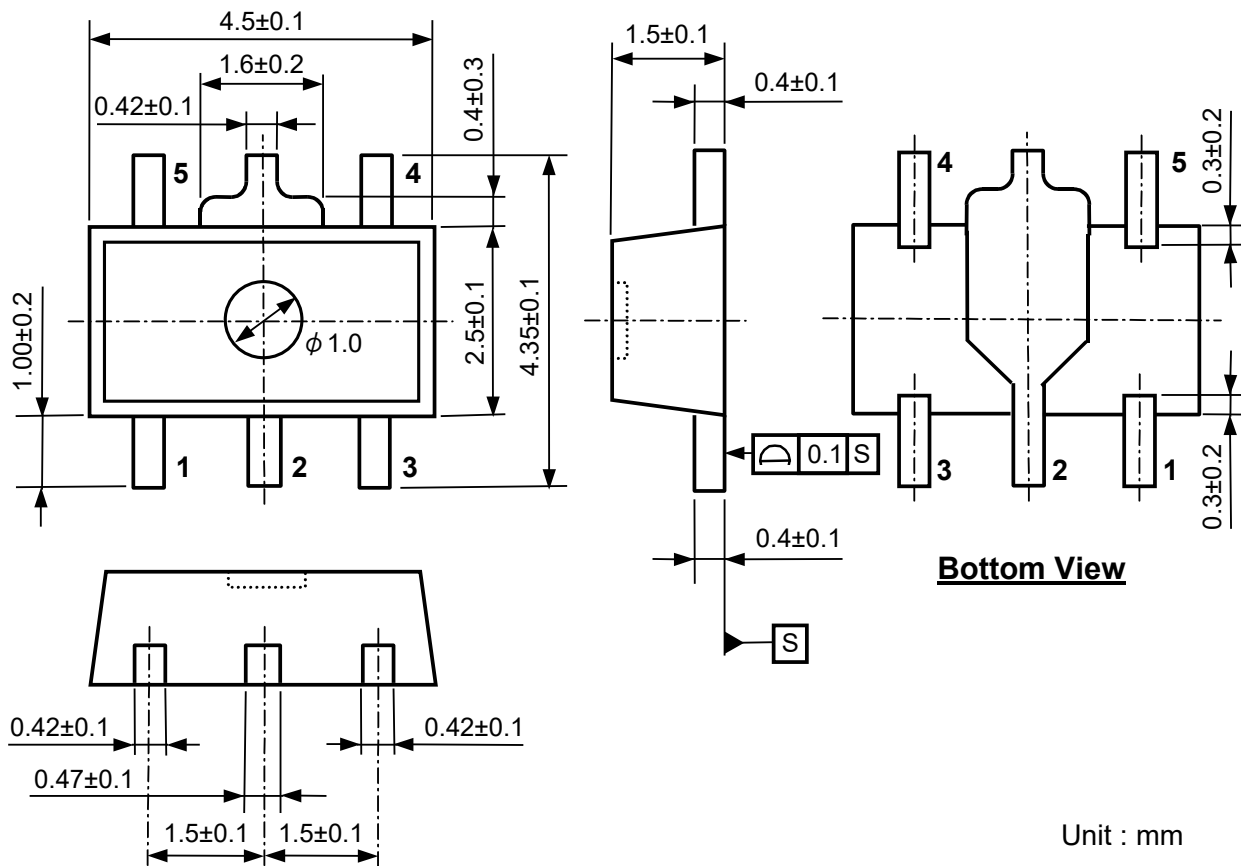

Mark Specification (SOT-89-5)

①②③④ : Product CodeRefer to the marking list table

⑤⑥ : Lot No.....Alphanumeric serial number.

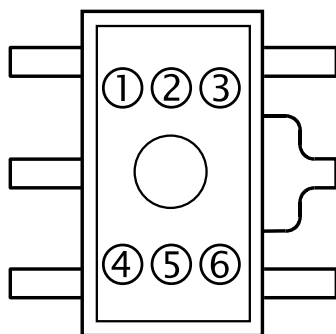

R1173H Series Marking List Table

PKG : SOT-89-5

R1173Hxx1B

Part Number	①②③④
R1173H081B	L08B
R1173H091B	L09B
R1173H101B	L10B
R1173H111B	L11B
R1173H121B	L12B
R1173H131B	L13B
R1173H141B	L14B
R1173H151B	L15B
R1173H161B	L16B
R1173H171B	L17B
R1173H181B	L18B
R1173H191B	L19B
R1173H201B	L20B
R1173H211B	L21B
R1173H221B	L22B
R1173H231B	L23B
R1173H241B	L24B
R1173H251B	L25B
R1173H261B	L26B
R1173H271B	L27B
R1173H281B	L28B
R1173H291B	L29B
R1173H301B	L30B
R1173H311B	L31B
R1173H321B	L32B
R1173H331B	L33B
R1173H341B	L34B
R1173H351B	L35B
R1173H361B	L36B
R1173H371B	L37B
R1173H381B	L38B
R1173H391B	L39B
R1173H401B	L40B
R1173H411B	L41B
R1173H421B	L42B
R1173H431B	L43B
R1173H441B	L44B
R1173H451B	L45B
R1173H461B	L46B
R1173H471B	L47B
R1173H481B	L48B
R1173H491B	L49B
R1173H501B	L50B
R1173H181B5	L01B
R1173H281B5	L02B
R1173H12B5	L03B
R1173H001B	L00B

R1173Hxx1D

Part Number	①②③④
R1173H081D	L08D
R1173H091D	L09D
R1173H101D	L10D
R1173H111D	L11D
R1173H121D	L12D
R1173H131D	L13D
R1173H141D	L14D
R1173H151D	L15D
R1173H161D	L16D
R1173H171D	L17D
R1173H181D	L18D
R1173H191D	L19D
R1173H201D	L20D
R1173H211D	L21D
R1173H221D	L22D
R1173H231D	L23D
R1173H241D	L24D
R1173H251D	L25D
R1173H261D	L26D
R1173H271D	L27D
R1173H281D	L28D
R1173H291D	L29D
R1173H301D	L30D
R1173H311D	L31D
R1173H321D	L32D
R1173H331D	L33D
R1173H341D	L34D
R1173H351D	L35D
R1173H361D	L36D
R1173H371D	L37D
R1173H381D	L38D
R1173H391D	L39D
R1173H401D	L40D
R1173H411D	L41D
R1173H421D	L42D
R1173H431D	L43D
R1173H441D	L44D
R1173H451D	L45D
R1173H461D	L46D
R1173H471D	L47D
R1173H481D	L48D
R1173H491D	L49D
R1173H501D	L50D
R1173H181D5	L01D
R1173H281D5	L02D
R1173H121D5	L03D
R1173H001D	L00D

Power Dissipation (HSON-6)

This specification is at mounted on board. Power Dissipation (P_D) depends on conditions of mounting on board. This specification is based on the measurement at the condition below:

Measurement Conditions

	Standard Land Pattern
Environment	Mounting on Board (Wind velocity=0m/s)
Board Material	Glass cloth epoxy plastic (Double sided)
Board Dimensions	40mm x 40mm x 1.6mm
Copper Ratio	Top side: Approx. 50%, Back side: Approx. 50%
Through-hole	ϕ 0.5mm x 44pcs

Measurement Result

($T_a=25^\circ\text{C}$, $T_{j\text{max}}=125^\circ\text{C}$)

	Standard Land Pattern	Free Air
Power Dissipation	900mW	400mW
Thermal Resistance	$\theta_{ja} = (125-25^\circ\text{C}) / 0.9\text{W} = 111^\circ\text{C/W}$	250°C/W

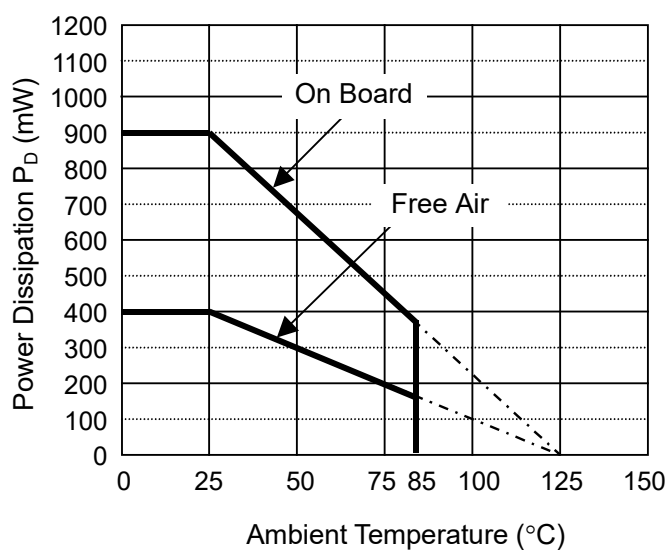

Power Dissipation

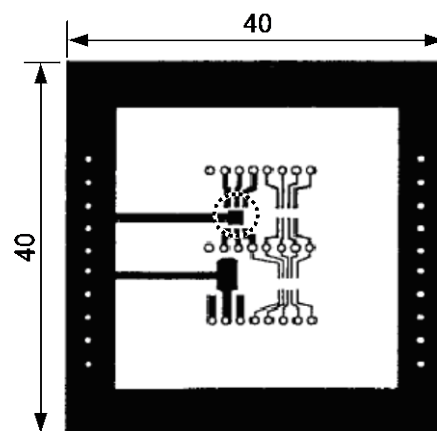

Measurement Board Pattern

 IC Mount Area Unit : mm

Package Dimensions (HSO6-6)

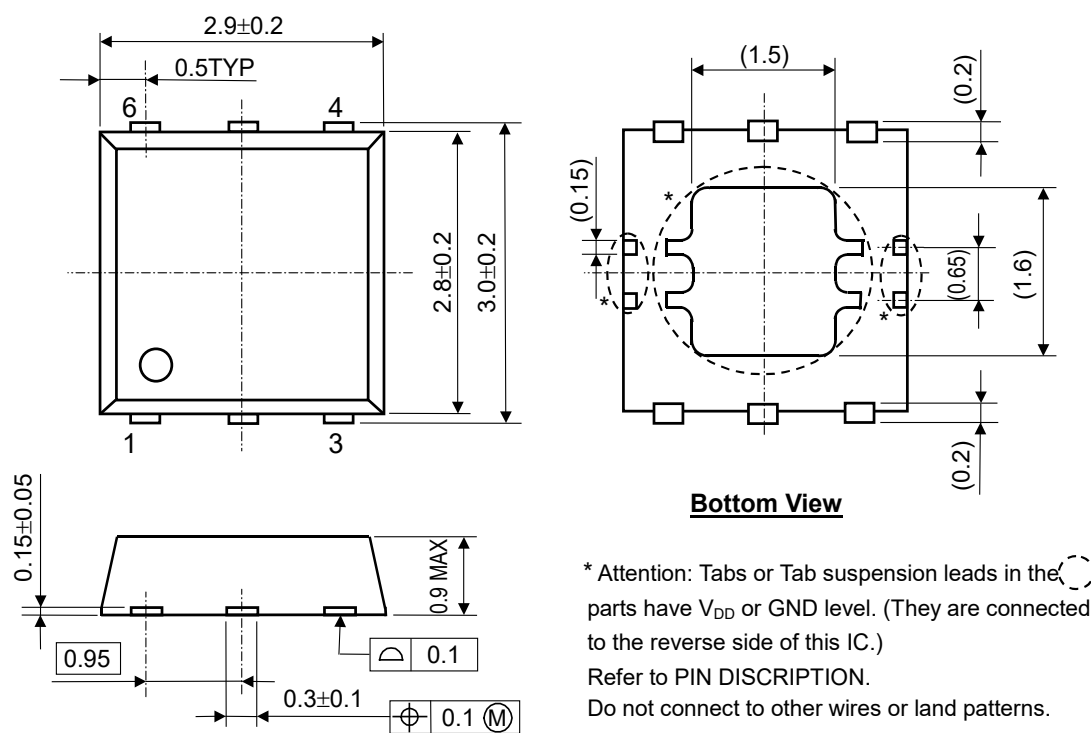

Bottom View

* Attention: Tabs or Tab suspension leads in the  parts have V_{DD} or GND level. (They are connected to the reverse side of this IC.)
Refer to PIN DISCRIPTION.
Do not connect to other wires or land patterns.

Unit: mm

Mark Specification (HSON-6)

①②③④ : Product Code .Refer to the marking list table

⑤⑥ : Lot No.Alphanumeric serial number.

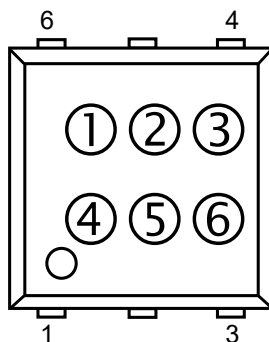

R1173D Series Marking List Table

PKG : HSON-6

R1173Dxx1B

Part Number	①②③④
R1173D081B	H08B
R1173D091B	H09B
R1173D101B	H10B
R1173D111B	H11B
R1173D121B	H12B
R1173D131B	H13B
R1173D141B	H14B
R1173D151B	H15B
R1173D161B	H16B
R1173D171B	H17B
R1173D181B	H18B
R1173D191B	H19B
R1173D201B	H20B
R1173D211B	H21B
R1173D221B	H22B
R1173D231B	H23B
R1173D241B	H24B
R1173D251B	H25B
R1173D261B	H26B
R1173D271B	H27B
R1173D281B	H28B
R1173D291B	H29B
R1173D301B	H30B
R1173D311B	H31B
R1173D321B	H32B
R1173D331B	H33B
R1173D341B	H34B
R1173D351B	H35B
R1173D361B	H36B
R1173D371B	H37B
R1173D381B	H38B
R1173D391B	H39B
R1173D401B	H40B
R1173D411B	H41B
R1173D421B	H42B
R1173D431B	H43B
R1173D441B	H44B
R1173D451B	H45B
R1173D461B	H46B
R1173D471B	H47B
R1173D481B	H48B
R1173D491B	H49B
R1173D501B	H50B
R1173D181B5	H01B
R1173D281B5	H02B
R1173D121B5	H03B
R1173D001B	H00B

R1173Dxx1D

Part Number	①②③④
R1173D081D	H08D
R1173D091D	H09D
R1173D101D	H10D
R1173D111D	H11D
R1173D121D	H12D
R1173D131D	H13D
R1173D141D	H14D
R1173D151D	H15D
R1173D161D	H16D
R1173D171D	H17D
R1173D181D	H18D
R1173D191D	H19D
R1173D201D	H20D
R1173D211D	H21D
R1173D221D	H22D
R1173D231D	H23D
R1173D241D	H24D
R1173D251D	H25D
R1173D261D	H26D
R1173D271D	H27D
R1173D281D	H28D
R1173D291D	H29D
R1173D301D	H30D
R1173D311D	H31D
R1173D321D	H32D
R1173D331D	H33D
R1173D341D	H34D
R1173D351D	H35D
R1173D361D	H36D
R1173D371D	H37D
R1173D381D	H38D
R1173D391D	H39D
R1173D401D	H40D
R1173D411D	H41D
R1173D421D	H42D
R1173D431D	H43D
R1173D441D	H44D
R1173D451D	H45D
R1173D461D	H46D
R1173D471D	H47D
R1173D481D	H48D
R1173D491D	H49D
R1173D501D	H50D
R1173D181D5	H01D
R1173D281D5	H02D
R1173D121D5	H03D
R1173D001D	H00D

Power Dissipation (HSOP-6J)

This specification is at mounted on board. Power Dissipation (P_D) depends on conditions of mounting on board. This specification is based on the measurement at the condition below:

Measurement Conditions

	High Wattage Land Pattern	Standard Land Pattern
Environment	Mounting on Board (Wind velocity=0m/s)	Mounting on Board (Wind velocity=0m/s)
Board Material	Glass cloth epoxy plastic (Double sided)	Glass cloth epoxy plastic (Double sided)
Board Dimensions	50mm x 50mm x 1.6mm	50mm x 50mm x 1.6mm
Copper Ratio	90%	50%
Through-hole	$\phi 0.5\text{mm} \times 24\text{pcs}$	$\phi 0.5\text{mm} \times 24\text{pcs}$

Measurement Result

($T_a=25^\circ\text{C}, T_{j\text{max}}=125^\circ\text{C}$)

	High Wattage Land Pattern	Standard Land Pattern	Free Air
Power Dissipation	2000mW	1700mW	540mW
Thermal Resistance	50°C/W	59°C/W	185°C/W

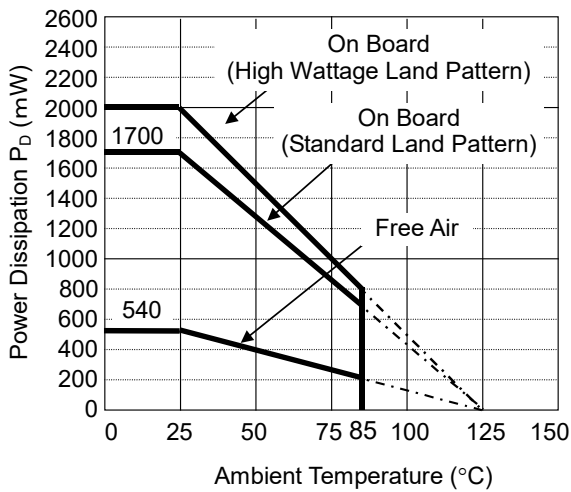

Power Dissipation

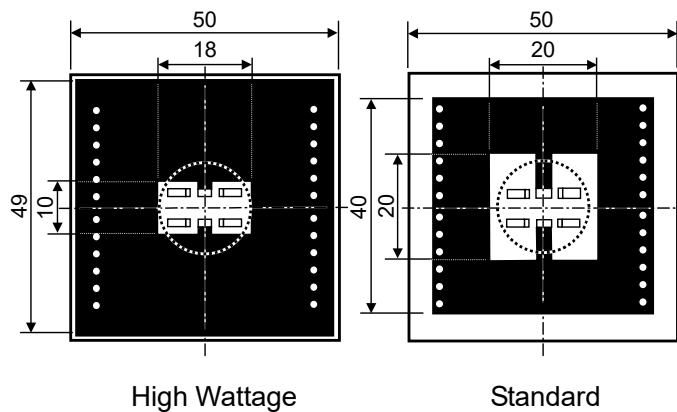

Measurement Board Pattern

IC Mount Area Unit : mm

Package Dimensions (HSOP-6J)

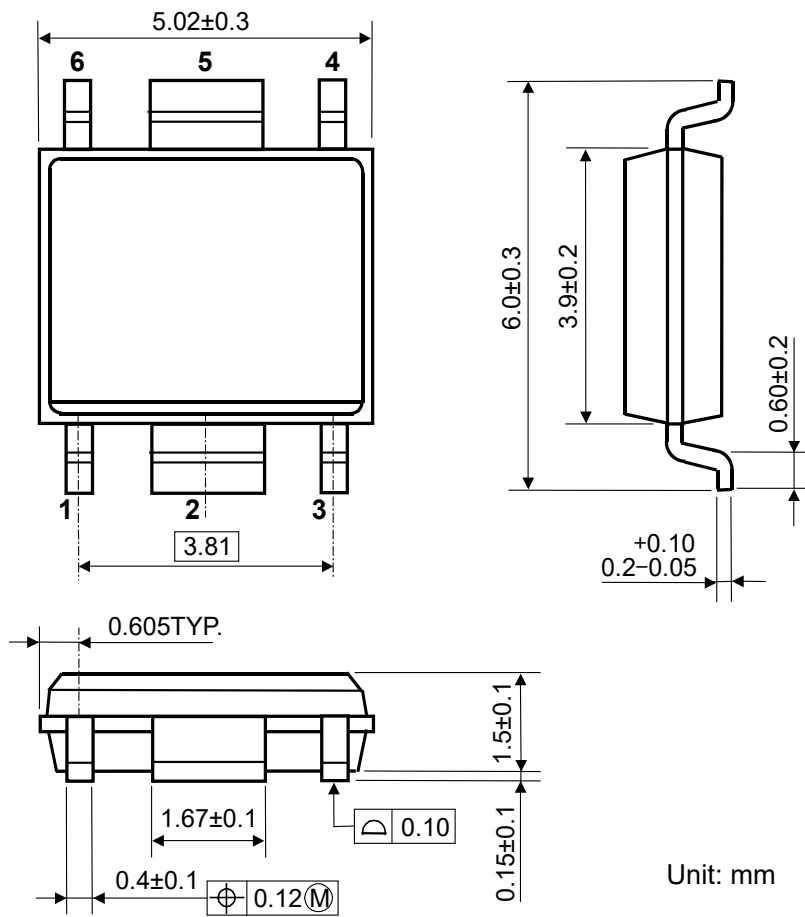

Mark Specification (HSOP-6J)

①②③④ : Product Code..... Refer to the marking list table.

⑤⑥ : Lot No. Alphanumeric serial number.

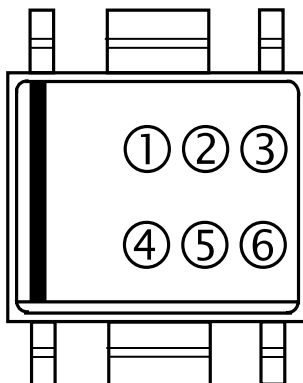

R1173S Series Marking List Table

PKG : HSOP-6J

R1173Sxx1B

Part Number	①②③④
R1173S081B	C08B
R1173S091B	C09B
R1173S101B	C10B
R1173S111B	C11B
R1173S121B	C12B
R1173S131B	C13B
R1173S141B	C14B
R1173S151B	C15B
R1173S161B	C16B
R1173S171B	C17B
R1173S181B	C18B
R1173S191B	C19B
R1173S201B	C20B
R1173S211B	C21B
R1173S221B	C22B
R1173S231B	C23B
R1173S241B	C24B
R1173S251B	C25B
R1173S261B	C26B
R1173S271B	C27B
R1173S281B	C28B
R1173S291B	C29B
R1173S301B	C30B
R1173S311B	C31B
R1173S321B	C32B
R1173S331B	C33B
R1173S341B	C34B
R1173S351B	C35B
R1173S361B	C36B
R1173S371B	C37B
R1173S381B	C38B
R1173S391B	C39B
R1173S401B	C40B
R1173S411B	C41B
R1173S421B	C42B
R1173S431B	C43B
R1173S441B	C44B
R1173S451B	C45B
R1173S461B	C46B
R1173S471B	C47B
R1173S481B	C48B
R1173S491B	C49B
R1173S501B	C50B
R1173S181B5	C01B
R1173S281B5	C02B
R1173S121B5	C03B
R1173S001B	C00B

R1173Sxx1D

Part Number	①②③④
R1173S081D	C08D
R1173S091D	C09D
R1173S101D	C10D
R1173S111D	C11D
R1173S121D	C12D
R1173S131D	C13D
R1173S141D	C14D
R1173S151D	C15D
R1173S161D	C16D
R1173S171D	C17D
R1173S181D	C18D
R1173S191D	C19D
R1173S201D	C20D
R1173S211D	C21D
R1173S221D	C22D
R1173S231D	C23D
R1173S241D	C24D
R1173S251D	C25D
R1173S261D	C26D
R1173S271D	C27D
R1173S281D	C28D
R1173S291D	C29D
R1173S301D	C30D
R1173S311D	C31D
R1173S321D	C32D
R1173S331D	C33D
R1173S341D	C34D
R1173S351D	C35D
R1173S361D	C36D
R1173S371D	C37D
R1173S381D	C38D
R1173S391D	C39D
R1173S401D	C40D
R1173S411D	C41D
R1173S421D	C42D
R1173S431D	C43D
R1173S441D	C44D
R1173S451D	C45D
R1173S461D	C46D
R1173S471D	C47D
R1173S481D	C48D
R1173S491D	C49D
R1173S501D	C50D
R1173S181D5	C01D
R1173S281D5	C02D
R1173S121D5	C03D
R1173S001D	C00D

1. The products and the product specifications described in this document are subject to change or discontinuation of production without notice for reasons such as improvement. Therefore, before deciding to use the products, please refer to our sales representatives for the latest information thereon.
2. The materials in this document may not be copied or otherwise reproduced in whole or in part without the prior written consent of us.
3. This product and any technical information relating thereto are subject to complementary export controls (so-called KNOW controls) under the Foreign Exchange and Foreign Trade Law, and related politics ministerial ordinance of the law. (Note that the complementary export controls are inapplicable to any application-specific products, except rockets and pilotless aircraft, that are insusceptible to design or program changes.) Accordingly, when exporting or carrying abroad this product, follow the Foreign Exchange and Foreign Trade Control Law and its related regulations with respect to the complementary export controls.
4. The technical information described in this document shows typical characteristics and example application circuits for the products. The release of such information is not to be construed as a warranty of or a grant of license under our or any third party's intellectual property rights or any other rights.
5. The products listed in this document are intended and designed for use as general electronic components in standard applications (office equipment, telecommunication equipment, measuring instruments, consumer electronic products, amusement equipment etc.). Those customers intending to use a product in an application requiring extreme quality and reliability, for example, in a highly specific application where the failure or misoperation of the product could result in human injury or death should first contact us.
 - Aerospace Equipment
 - Equipment Used in the Deep Sea
 - Power Generator Control Equipment (nuclear, steam, hydraulic, etc.)
 - Life Maintenance Medical Equipment
 - Fire Alarms / Intruder Detectors
 - Vehicle Control Equipment (automotive, airplane, railroad, ship, etc.)
 - Various Safety Devices
 - Traffic control system
 - Combustion equipment

In case your company desires to use this product for any applications other than general electronic equipment mentioned above, make sure to contact our company in advance. Note that the important requirements mentioned in this section are not applicable to cases where operation requirements such as application conditions are confirmed by our company in writing after consultation with your company.

6. We are making our continuous effort to improve the quality and reliability of our products, but semiconductor products are likely to fail with certain probability. In order to prevent any injury to persons or damages to property resulting from such failure, customers should be careful enough to incorporate safety measures in their design, such as redundancy feature, fire containment feature and fail-safe feature. We do not assume any liability or responsibility for any loss or damage arising from misuse or inappropriate use of the products.
7. The products have been designed and tested to function within controlled environmental conditions. Do not use products under conditions that deviate from methods or applications specified in this datasheet. Failure to employ the products in the proper applications can lead to deterioration, destruction or failure of the products. We shall not be responsible for any bodily injury, fires or accident, property damage or any consequential damages resulting from misuse or misapplication of the products.
8. **Quality Warranty**
 - 8-1. **Quality Warranty Period**

In the case of a product purchased through an authorized distributor or directly from us, the warranty period for this product shall be one (1) year after delivery to your company. For defective products that occurred during this period, we will take the quality warranty measures described in section 8-2. However, if there is an agreement on the warranty period in the basic transaction agreement, quality assurance agreement, delivery specifications, etc., it shall be followed.
 - 8-2. **Quality Warranty Remedies**

When it has been proved defective due to manufacturing factors as a result of defect analysis by us, we will either deliver a substitute for the defective product or refund the purchase price of the defective product.

Note that such delivery or refund is sole and exclusive remedies to your company for the defective product.
 - 8-3. **Remedies after Quality Warranty Period**

With respect to any defect of this product found after the quality warranty period, the defect will be analyzed by us. On the basis of the defect analysis results, the scope and amounts of damage shall be determined by mutual agreement of both parties. Then we will deal with upper limit in Section 8-2. This provision is not intended to limit any legal rights of your company.
9. Anti-radiation design is not implemented in the products described in this document.
10. The X-ray exposure can influence functions and characteristics of the products. Confirm the product functions and characteristics in the evaluation stage.
11. WLCSP products should be used in light shielded environments. The light exposure can influence functions and characteristics of the products under operation or storage.
12. Warning for handling Gallium and Arsenic (GaAs) products (Applying to GaAs MMIC, Photo Reflector). These products use Gallium (Ga) and Arsenic (As) which are specified as poisonous chemicals by law. For the prevention of a hazard, do not burn, destroy, or process chemically to make them as gas or power. When the product is disposed of, please follow the related regulation and do not mix this with general industrial waste or household waste.
13. Please contact our sales representatives should you have any questions or comments concerning the products or the technical information.



Nisshinbo Micro Devices Inc.

Official website

<https://www.nisshinbo-microdevices.co.jp/en/>

Purchase information

<https://www.nisshinbo-microdevices.co.jp/en/buy/>