



soberton inc.

PIEZOELECTRIC CERAMIC ELEMENT

Acoustic Product Specification

Product Number: PT-1303T

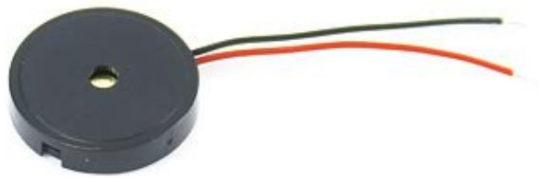

Release | Revision: A/2022

CONTENTS

This document contains the technical specifications for the piezoelectric ceramic buzzer (Lead wire type).

Page 1
Specifications

Dimensions

Page 2
Reliability Test

Page 3
Frequency Response

Electrical And Acoustical
Measuring Condition

Page 4
Packing

Specifications

Item	Unit	Specification
Resonant Frequency	Hz	4000±500
Operating Voltage	Vp-p	1 ~ 25
Rated Voltage	Vp-p	5
Rated Current	mA	Max. 5 at 4.0KHz 50% duty cycle, square wave, 5 Vp-p
Sound Output	dB	Min. 75 at 4.0KHz 50% duty cycle, square wave, 5 Vp-p
Capacitance	pF	10000±30%, at 120Hz
Operating Temperature	°C	-20 ~ +70
Storage Temperature	°C	-30 ~ +80
Lead Wire Length	mm	L1= 25, L2=3.5±0.3
Type of Wire		Lead Wire UL1571 / AWG #32
Dimensions	mm	Φ13.0×H3.0
Housing Material		Black ABS
Net Weight	gram	Approx. 0.8
Environmental Protection Regulation		RoHS 2.0

Dimensions

Unit: mm
Tolerance: ±0.5mm, except where specified

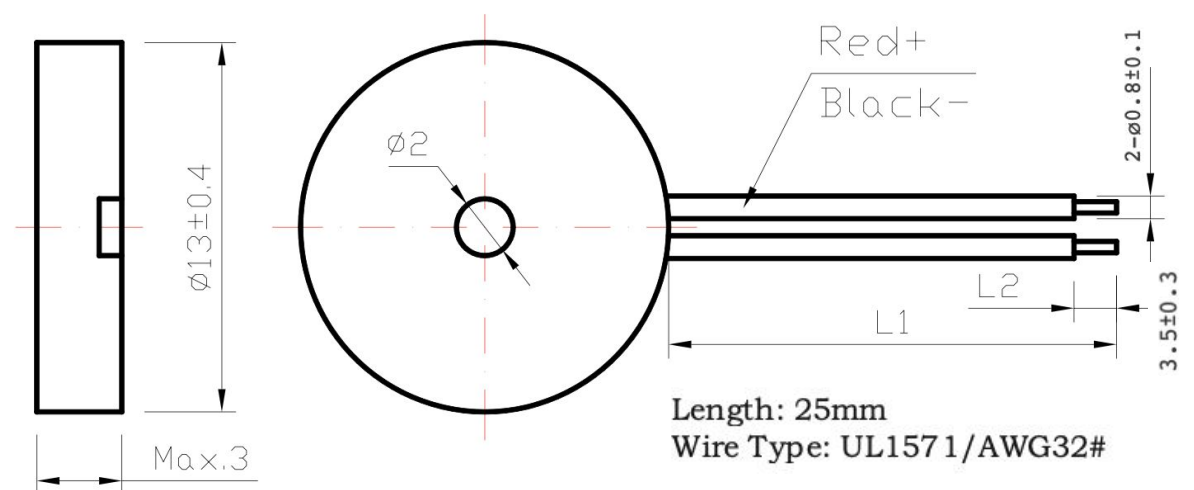

Housing Material: Black ABS



soberton inc.

PIEZOELECTRIC CERAMIC ELEMENT

Acoustic Product Specification

Product Number: PT-1303T

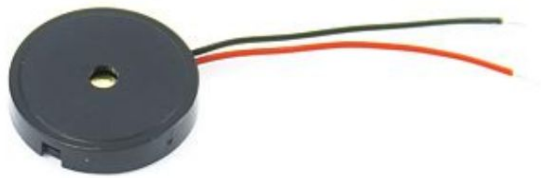

Release | Revision: A/2022

CONTENTS

This document contains the technical specifications for the piezoelectric ceramic buzzer (Lead wire type).

Page 1

Specifications

Dimensions

Page 2

Reliability Test

Page 3

Frequency Response

Electrical And Acoustical
Measuring Condition

Page 4

Packing

Reliability Test

After any of the following tests the part shall meet specifications without any degradation in appearance and performance except SPL. SPL shall meet the specifications and shall not deviate more than -10dB from initial value.

Standard Temperature Life Test

The part shall be subjected to 96 hours at $25\pm 10^{\circ}\text{C}$.

Input rated voltage: 5 Vp-p

Resonant frequency: 4000Hz, 50% duty cycle, square wave

High Temperature Test

The part shall be capable of withstanding a storage temperature of $+80^{\circ}\text{C}$ for 96 hours.

Low Temperature Test

The part shall be capable of withstanding a storage temperature of -30°C for 96 hours.

Humidity Test

Temperature $+40^{\circ}\text{C}\pm 3^{\circ}\text{C}$

Relative Humidity 90%~95%

Duration 48 hours and exposure to room temperature for 6 hours

Temperature Shock Test

Per cycle

$70^{\circ}\text{C}/1\text{ hour} \rightarrow 25^{\circ}\text{C}/3\text{ hours} \rightarrow -30^{\circ}\text{C}/1\text{ hour} \rightarrow 25^{\circ}\text{C}/3\text{ hours}$

Total cycle 10 cycles

Drop Test

Standard Packaging from 1.2m

Drop on hardwood or board of 5cm thick, three sides, six plain

Vibration Test

Vibration 1000 cycles /minute

Amplitude 1.5mm

Duration 1 hour in each 3 axes

Note

Please make sure that any foreign materials (e.g. magnetic powder, washing solvent, flux, corrosive gas) do not enter this product in your production processes. Contamination may result in a loss of some or all audio output.



soberton inc.

PIEZOELECTRIC CERAMIC ELEMENT

Acoustic Product Specification

Product Number: PT-1303T

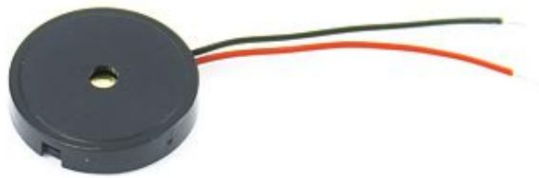

Release | Revision: A/2022

CONTENTS

This document contains the technical specifications for the piezoelectric ceramic buzzer (Lead wire type).

Page 1
Specifications

Dimensions

Page 2
Reliability Test

Page 3
Frequency Response

Electrical And Acoustical
Measuring Condition

Page 4
Packing

Frequency Response

5 Vp-p, 50% duty cycle, square wave, at 10cm

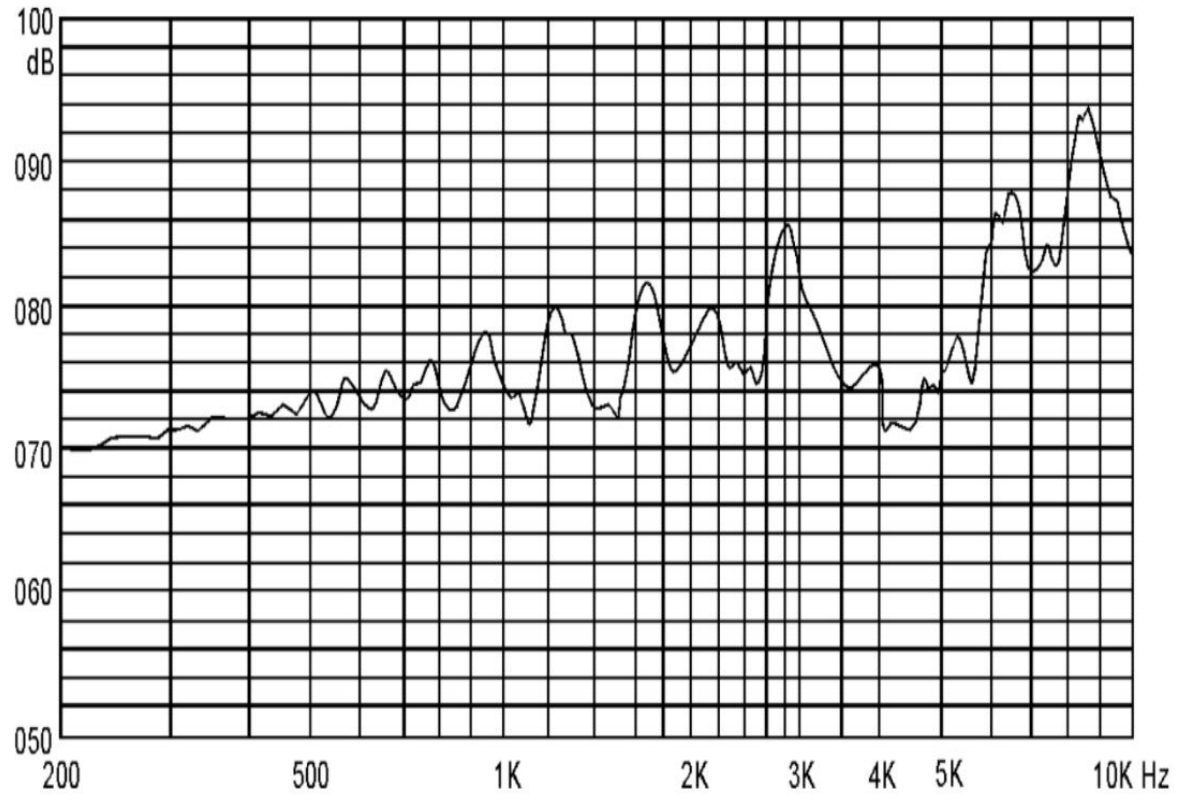

Electrical And Acoustical Measuring Condition

Recommended Setting

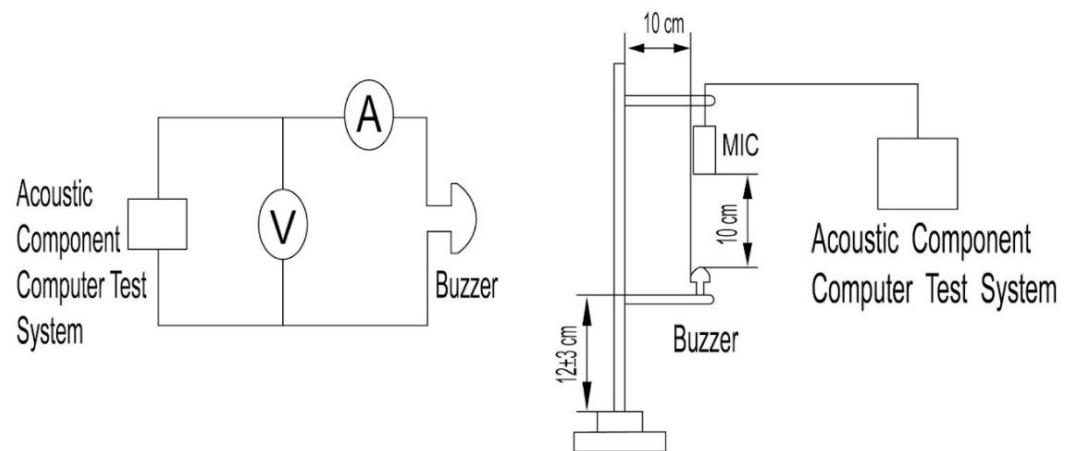



soberton inc.

PIEZOELECTRIC CERAMIC ELEMENT

Acoustic Product Specification

Product Number: PT-1303T

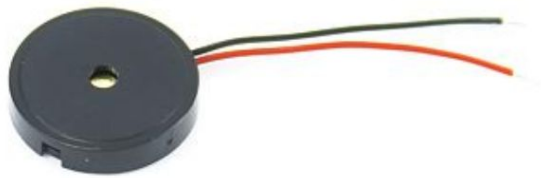

Release | Revision: A/2022

CONTENTS

This document contains the technical specifications for the piezoelectric ceramic buzzer (Lead wire type).

Page 1
Specifications

Dimensions

Page 2
Reliability Test

Page 3
Frequency Response

Electrical And Acoustical
Measuring Condition

Page 4
Packing

Packing



500pcs



4 Bags



500pcs x4=2000pcs

Package Item	Package Qty
Per Bag	500pcs
Per Carton	4 Bags
Per Carton	2000pcs