

# Film Capacitors

## Metallized Polypropylene Film Capacitors (MKP)

**Series/Type:** B32774P ... B32778P

**Date:** December 2020

**MKP DC link – 125 °C series up to 50 µF****Typical applications**

- Frequency converters
- Industrial and high-end power supplies
- Automotive DC-DC and Compressor

**Climatic**

- Max. operating temperature: 125 °C (case)
- Climatic category (IEC 60068-1:2013):  
40/110/56

**Construction**

- Dielectric: Polypropylene (MKP)
- Plastic case (UL 94 V-0)
- Epoxy resin sealing (UL 94 V-0)

**Features**

- Capacitance value up to 50 µF
- Good self-healing properties
- Over-voltage capability
- Low losses with high current capability
- High reliability
- RoHS-compatible
- AEC-Q200D compliant

**Terminals**

- Parallel wire leads, lead-free tinned
- 2-pin and 4-pin
- Standard lead lengths: 6 – 1 mm

**Marking**

Manufacturer's logo and lot number,  
date code, rated capacitance (coded),  
capacitance tolerance (code letter),  
rated DC voltage

**Delivery mode**

Bulk (untaped, lead length 6 – 1 mm)

**Dimensional drawings**

Number of wires	Lead spacing $e \pm 0.4$	Lead diameter $d_1 \pm 0.05$	Type
2-pin	27.5	1.0 <sup>1)</sup>	B32774P
2-pin	37.5	1.0	B32776P
2-pin	37.5	1.0 <sup>1)</sup>	B32776P
4-pin	37.5	1.2 <sup>1)</sup>	B32776P
4-pin	52.5	1.2 <sup>1)</sup>	B32778P

Dimensions in mm

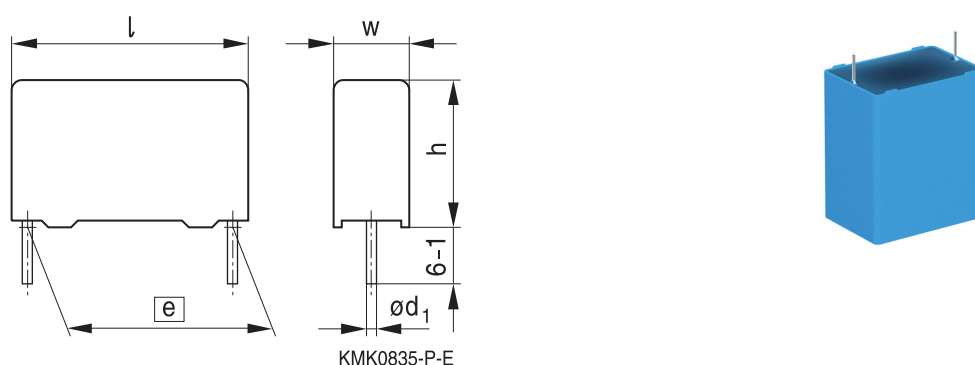
**Dimensional drawings 2-pin versions**
**B32774P, B32776P**

	B32774P	B32776P
Lead spacing $e \pm 0.4$ :	27.5	37.5
Lead diameter $d_1$ :	1.0 <sup>1)</sup>	1.0

Dimensions in mm

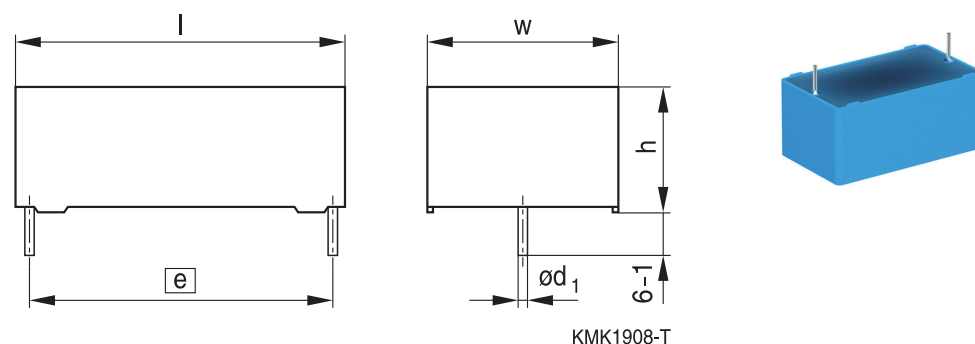
**B32776P**

Lead spacing $e \pm 0.4$ :	37.5
Lead diameter $d_1$ :	1.0 <sup>1)</sup>

Dimensions in mm

1) Reinforced for vibration



**B32774P ... B32778P**

**MKP DC link – 125 °C series up to 50 µF**

**Dimensional drawings 4-pin versions**

**B32776P, B32778P**

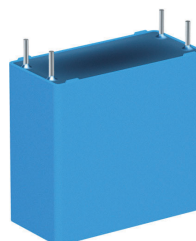
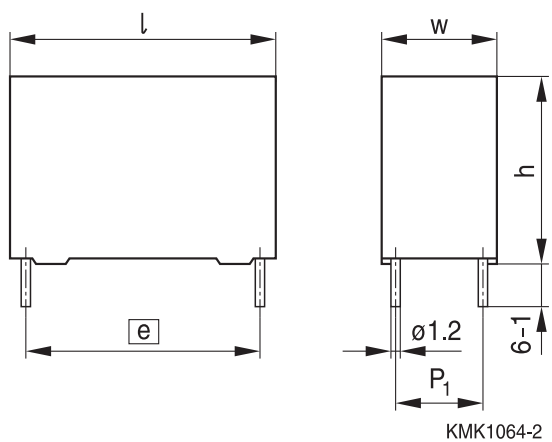

	B32776P	B32778P
Lead spacing $e \pm 0.4$ :	37.5	52.5
Lead diameter $d_1$ :	1.2 <sup>2)</sup>	1.2 <sup>2)</sup>

Dimensions in mm

2) Reinforced for vibration



**Overview of available types**

Lead spacing	27.5 mm			37.5 mm			52.5 mm		
Type	B32774P			B32776P			B32778P		
Page	6			7			8		
V <sub>R</sub> (V DC)	630	700	840	630	700	840	630	700	840
C <sub>R</sub> (µF)									
1.0									
1.5									
2.0									
2.2									
2.7									
3.0									
3.3									
3.5									
3.9									
4.7									
5.0									
6.8									
7.0									
7.5									
8.0									
10									
12									
14									
15									
16									
20									
22									
25									
27									
30									
35									
40									
50									

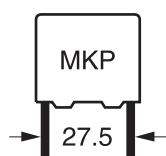
**B32774P**
**MKP DC link – 125 °C series up to 50 µF**
**Ordering codes and packing units (lead spacing 27.5 mm)**

$C_R^{1)}$ µF	Max. dimensions w × h × l mm	Ordering code (composition see below)	$I_{RMS,max}^{2)}$ 85 °C 10 kHz A	$ESR_{typ}$ 10 kHz mΩ	$ESL_{typ}^{3)}$ nH	tan δ max. 1 kHz 10 <sup>-3</sup>	tan δ max. 10 kHz 10 <sup>-3</sup>	Un- taped pcs./ MOQ
<b><math>V_{R,85\text{ °C}} = 630\text{ V DC}</math></b>								
1.5	11.0 × 19.0 × 31.5	B32774P6155+000	3.5	22.3	13.2	0.5	3.5	1280
2.2	12.5 × 21.5 × 31.5	B32774P6225+000	4.7	15.5	14.5	0.5	3.5	1120
3.0	14.0 × 24.5 × 31.5	B32774P6305+000	6.0	11.5	16.1	0.5	3.5	1040
4.7	18.0 × 27.5 × 31.5	B32774P6475+000	8.2	7.6	18.7	0.5	3.7	800
6.8	21.0 × 31.0 × 31.5	B32774P6685+000	10.4	5.4	21.3	0.6	3.9	720
8.0	22.0 × 36.5 × 31.5	B32774P6805+000	12.0	4.5	24.0	0.6	4.0	640
<b><math>V_{R,85\text{ °C}} = 700\text{ V DC}</math></b>								
1.5	11.0 × 19.0 × 31.5	B32774P7155+000	3.6	20.3	18.4	0.5	3.2	1280
2.0	12.5 × 21.5 × 31.5	B32774P7205+000	4.7	15.3	19.8	0.5	3.2	1120
3.3	18.0 × 27.5 × 31.5	B32774P7335+000	7.3	9.6	22.9	0.5	3.3	800
4.7	19.0 × 30.0 × 31.5	B32774P7475+000	9.0	6.9	25.8	0.5	3.4	720
7.0	22.0 × 36.5 × 31.5	B32774P7705+000	11.8	5.0	31.2	0.5	3.7	640
<b><math>V_{R,85\text{ °C}} = 840\text{ V DC}</math></b>								
1.0	11.0 × 19.0 × 31.5	B32774P8105+000	3.3	25.2	18.3	0.5	2.7	1280
1.5	12.5 × 21.5 × 31.5	B32774P8155+000	4.4	17.2	20.2	0.5	2.7	1120
3.0	18.0 × 27.5 × 31.5	B32774P8305+000	7.5	9.1	25.6	0.5	2.8	800
5.0	22.0 × 36.5 × 31.5	B32774P8505+000	12.5	5.8	31.6	0.5	3.0	640

MOQ = Minimum Order Quantity, consisting of 4 packing units.

Intermediate capacitance values are available on request.

**Composition of ordering code**

+ = Capacitance tolerance code:

K = ±10%

J = ±5%

Packing code:

000 = untaped (lead length 6 – 1 mm)

Other lead lengths available upon request

1) Capacitance value measured at 1 kHz

2) Max. ripple current  $I_{RMS}$  at 85 °C at 10 kHz for a  $\Delta T \leq 15\text{ °C}$  when  $\Delta ESR_{typ} \leq \pm 5\%$

3) ESL value measured at resonance frequency (see specific graphs of Z versus frequency)

**Ordering codes and packing units (lead spacing 37.5 mm)**

$C_R^{1)}$ µF	Max. dimensions w × h × l mm	$P_1$ mm	Ordering code (composition see below)	$I_{RMS,max}^{2)}$ 85 °C 10 kHz A	$ESR_{typ}$ 10 kHz mΩ	$ESL_{typ}^{3)}$ nH	$\tan \delta$ max. 1 kHz $10^{-3}$	$\tan \delta$ max. 10 kHz $10^{-3}$	Un- taped pcs./ MOQ
<b><math>V_{R,85\text{ °C}} = 630\text{ V DC}</math></b>									
5.0	24.0 × 15.0 × 42.0	–	B32776P6505+000	6.0	13.4	19.4	0.9	6.9	1040
7.5	24.0 × 19.0 × 42.0	–	B32776P6755K000	7.6	9.5	19.6	0.9	6.9	780
10.0	18.0 × 32.5 × 42.0	–	B32776P6106K000	9.6	7.0	23.4	0.9	7.2	720
15.0	20.0 × 39.5 × 42.0	10.2	B32776P6156K000	13.0	4.8	12.4	0.9	7.1	640
20.0	28.0 × 37.0 × 42.0	10.2	B32776P6206K000	16.0	3.6	11.5	0.9	7.1	440
22.0	28.0 × 42.5 × 42.0	10.2	B32776P6226K000	17.5	3.2	13.2	0.9	7.3	440
25.0	30.0 × 45.0 × 42.0	20.3	B32776P6256+000	19.5	2.9	13.9	0.9	7.4	400
30.0	33.0 × 48.0 × 42.0	20.3	B32776P6306+000	22.5	2.4	15.1	0.9	7.6	180
<b><math>V_{R,85\text{ °C}} = 700\text{ V DC}</math></b>									
3.9	24.0 × 15.0 × 42.0	–	B32776P7395+000	5.6	15.3	19.2	0.8	6.2	1040
5.0	24.0 × 19.0 × 42.0	–	B32776P7505+000	6.8	12.1	19.1	0.8	6.3	780
12.0	20.0 × 39.5 × 42.0	10.2	B32776P7126K000	12.5	5.3	12.4	0.8	6.4	640
14.0	28.0 × 37.0 × 42.0	10.2	B32776P7146+000	14.5	4.4	11.3	0.8	6.4	440
16.0	28.0 × 42.5 × 42.0	10.2	B32776P7166+000	16.0	3.9	12.5	0.8	6.5	440
20.0	30.0 × 45.0 × 42.0	20.3	B32776P7206+000	19.0	3.2	13.5	0.8	6.6	400
22.0	33.0 × 48.0 × 42.0	20.3	B32776P7226+000	20.5	2.9	14.2	0.9	6.7	180
<b><math>V_{R,85\text{ °C}} = 840\text{ V DC}</math></b>									
2.7	24.0 × 15.0 × 42.0	–	B32776P8275+000	5.2	18.6	19.2	0.7	5.2	1040
3.5	24.0 × 19.0 × 42.0	–	B32776P8355+000	6.2	14.3	19.2	0.7	5.2	780
8.0	20.0 × 39.5 × 42.0	10.2	B32776P8805+000	11.0	6.3	12.4	0.7	5.3	640
10.0	28.0 × 37.0 × 42.0	10.2	B32776P8106+000	13.5	5.1	11.5	0.7	5.3	440
12.0	28.0 × 42.5 × 42.0	10.2	B32776P8126+000	15.0	4.4	12.8	0.7	5.4	440
14.0	30.0 × 45.0 × 42.0	20.3	B32776P8146+000	17.0	3.8	13.7	0.7	5.5	400
16.0	33.0 × 48.0 × 42.0	20.3	B32776P8166+000	19.0	3.3	14.5	0.7	5.5	180

MOQ = Minimum Order Quantity, consisting of 4 packing units.

Intermediate capacitance values are available on request.

**Composition of ordering code**

+ = Capacitance tolerance code:

K = ±10%

J = ±5%

Packing code:

000 = untaped (lead length 6 – 1 mm)

Other lead lengths available upon request

1) Capacitance value measured at 1 kHz

2) Max. ripple current  $I_{RMS}$  at 85 °C at 10 kHz for a  $\Delta T \leq 15\text{ °C}$  when  $\Delta ESR_{typ} \leq \pm 5\%$

3) ESL value measured at resonance frequency (see specific graphs of Z versus frequency)

**B32778P**
**MKP DC link – 125 °C series up to 50 µF**
**Ordering codes and packing units (lead spacing 52.5 mm, P<sub>1</sub> = 20.3 mm)**

C <sub>R</sub> <sup>1)</sup> µF	Max. dimensions w × h × l mm	Ordering code (composition see below)	I <sub>RMS,max</sub> <sup>2)</sup> 85 °C 10 kHz A	ESR <sub>typ</sub> 10 kHz mΩ	ESL <sub>typ</sub> <sup>3)</sup> nH	tan δ max. 1 kHz 10 <sup>-3</sup>	tan δ max. 10 kHz 10 <sup>-3</sup>	Un- taped pcs./ MOQ
<b>V<sub>R,85 °C</sub> = 630 V DC</b>								
35.0	30.0 × 45.0 × 57.5	B32778P6356+000	18.5	4.0	13.9	1.6	14.3	280
50.0	35.0 × 50.0 × 57.5	B32778P6506K000	23.5	2.9	16.0	1.6	14.8	108
<b>V<sub>R,85 °C</sub> = 700 V DC</b>								
30.0	30.0 × 45.0 × 57.5	B32778P7306+000	18.5	4.2	14.2	1.5	12.9	280
40.0	35.0 × 50.0 × 57.5	B32778P7406+000	22.5	3.2	15.9	1.5	13.2	108
<b>V<sub>R,85 °C</sub> = 840 V DC</b>								
20.0	30.0 × 45.0 × 57.5	B32778P8206+000	16.5	5.1	14.0	1.2	10.6	280
27.0	35.0 × 50.0 × 57.5	B32778P8276+000	20.5	3.9	15.7	1.3	10.8	108

MOQ = Minimum Order Quantity, consisting of 4 packing units.

Intermediate capacitance values are available on request.

**Composition of ordering code**

+ = Capacitance tolerance code:

K = ±10%

J = ±5%

Packing code:

000 = untaped (lead length 6 – 1 mm)

Other lead lengths available upon request

1) Capacitance value measured at 1 kHz

2) Max. ripple current I<sub>RMS</sub> at 85 °C at 10 kHz for a ΔT ≤ 15 °C when ΔESR<sub>typ</sub> ≤ ±5%

3) ESL value measured at resonance frequency (see specific graphs of Z versus frequency)





### Technical data

Reference standard: IEC 60384-16:2005 and AEC-Q200D. All data given at T = 20 °C, unless otherwise specified.

Rated temperature T <sub>R</sub>	+85 °C		
Operating temperature range (case)	Max. operating temperature, T <sub>op,max</sub>	+125 °C <sup>1)</sup>	
	Upper category temperature T <sub>max</sub>	+110 °C	
	Lower category temperature T <sub>min</sub>	–40 °C	
Insulation resistance R <sub>ins</sub> given as time constant τ = C <sub>R</sub> · R <sub>ins</sub> , rel. humidity ≤ 65% (minimum as-delivered values)	τ > 10000 s (after 1 min) at 500 V DC		
DC voltage test between terminals (10 s)	1.5 · V <sub>R</sub>		
Voltage test terminal to case (10 s)	2110 V AC, 50 Hz		
Peak current I <sub>P</sub> (A)	C (µF) · dV/dt		
V <sub>R</sub> (V DC) at 85 °C <sup>1)</sup>	630	700	840
Continuous operating voltage V <sub>op</sub> at 105 °C <sup>1)</sup>	540	600	720
Continuous operating voltage V <sub>op</sub> at 125 °C <sup>1)</sup>	450	500	600
For temperatures between 85 °C and 125 °C <sup>1)</sup>	0.7%/°C of V <sub>op</sub> derating compared to V <sub>op</sub> at 85 °C		
Reliability:			
Failure rate λ	5 fit (≤ 5 · 10 <sup>-9</sup> h) at 0.5 · V <sub>R</sub> , 40 °C		
Service life t <sub>SL</sub>	40 000 h at V <sub>R</sub> , 85 °C		
	For conversion to other operating conditions and temperatures, refer to chapter "Quality, 2 Reliability".		

1) Temperatures given as operating temperature T<sub>op</sub> (ambient temperature + self-heating), for example when ambient temperature is 125 °C, selfheating is 0 °C, or ripple current cannot be permitted.

### Typical waveforms

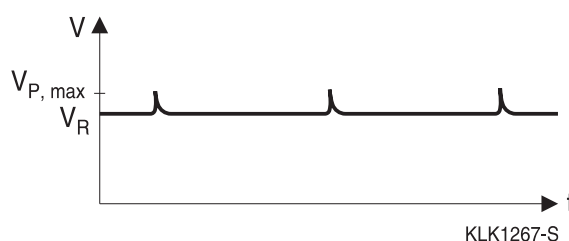
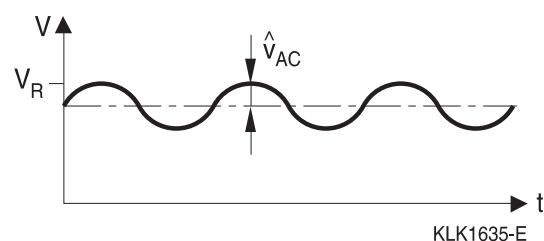

Restrictions:

**V<sub>R</sub>**: Maximum operating peak voltage of either polarity but of a non-reversing waveform, for which the capacitor has been designed for continuous operation.



**B32774P ... B32778P**

**MKP DC link – 125 °C series up to 50 µF**

$$\hat{u}_{AC} \leq 0.2 \cdot V_R$$

$$V_{p,max}$$

Overvoltage	Maximum duration within one day
$1.1 \cdot V_R$	30% of on-load duration
$1.15 \cdot V_R$	30 min.
$1.2 \cdot V_R$	5 min.
$1.3 \cdot V_R$	1 min.

### Pulse handling capability

"dV/dt" represents the maximum permissible voltage change per unit of time for non-sinusoidal voltages, expressed in V/µs.

*Note:*

*The values of dV/dt and  $k_0$  provided below must not be exceeded in order to avoid damaging the capacitor. These parameters are given for isolated pulses in such a way that the heat generated by one pulse will be completely dissipated before applying the next pulse. For a train of pulses, please refer to the curves of permissible AC voltage-current versus frequency.*

### dV/dt values

Lead spacing	27.5 mm			37.5 mm			52.5 mm		
Type	B32774P			B32776P			B32778P		
$V_R$ (V DC)	630	700	840	630	700	840	630	700	840
dV/dt in V/µs	50	75	100	35	54	73	25	35	50

B32774P

MKP DC link – 125 °C series up to 50  $\mu\text{F}$

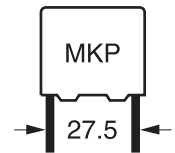

### Characteristics curves

Additional technical information can be found under "Design support" on [www.epcos.com](http://www.epcos.com).

#### Impedance Z versus frequency f (typical values)

Lead spacing 27.5 mm

630 V DC

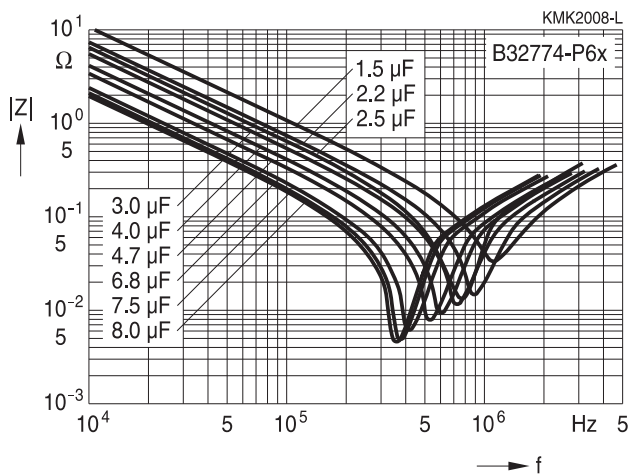

#### ESR versus frequency f (typical values)

Lead spacing 27.5 mm

630 V DC

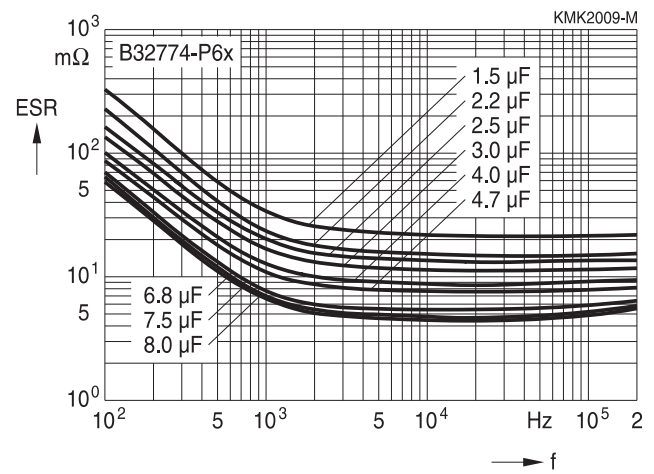

#### Impedance Z versus frequency f (typical values)

Lead spacing 27.5 mm

700 V DC

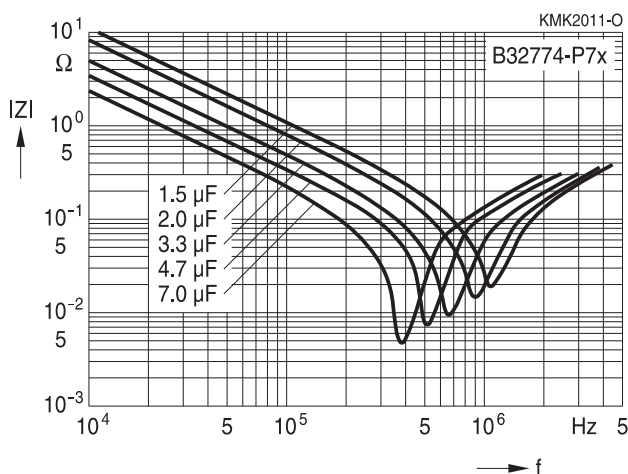

#### ESR versus frequency f (typical values)

Lead spacing 27.5 mm

700 V DC

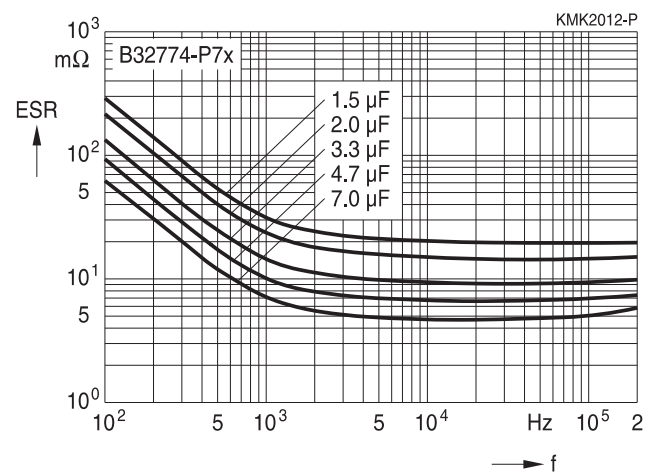



**B32774P**

**MKP DC link – 125 °C series up to 50  $\mu$ F**

**Characteristics curves**

Additional technical information can be found under "Design support" on [www.epcos.com](http://www.epcos.com).

**Impedance Z versus frequency f**  
(typical values)

**Lead spacing 27.5 mm**

840 V DC

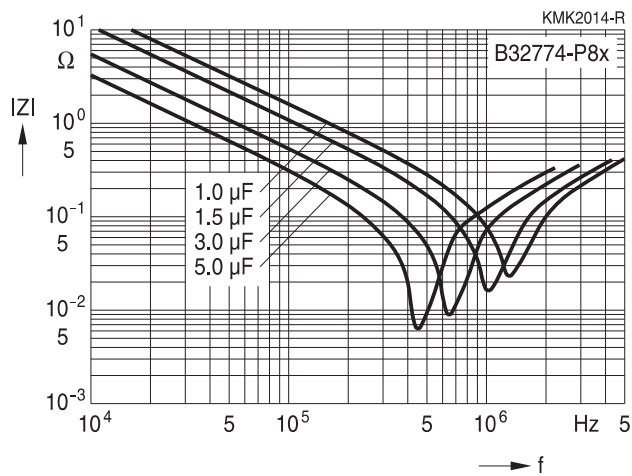

**ESR versus frequency f**  
(typical values)

**Lead spacing 27.5 mm**

840 V DC

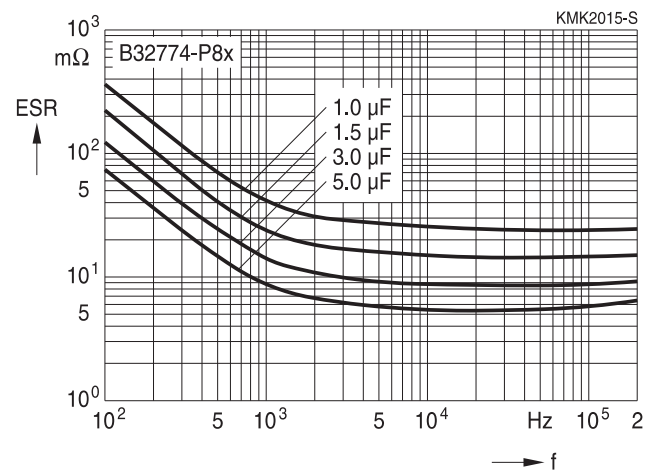

**B32776P**

**MKP DC link – 125 °C series up to 50 μF**



**Characteristics curves**

Additional technical information can be found under "Design support" on [www.epcos.com](http://www.epcos.com).

**Impedance Z versus frequency f**  
(typical values)

**Lead spacing 37.5 mm**

630 V DC

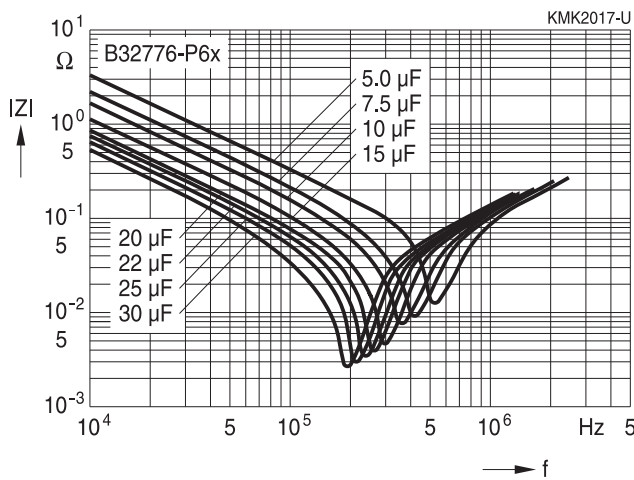

**ESR versus frequency f**  
(typical values)

**Lead spacing 37.5 mm**

630 V DC

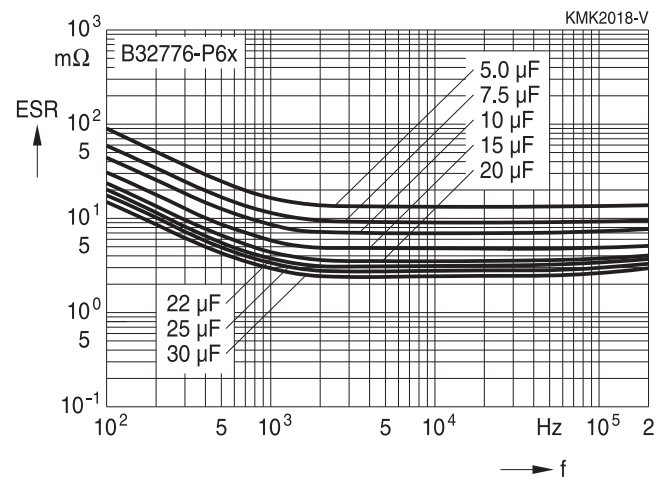

**Impedance Z versus frequency f**  
(typical values)

**Lead spacing 37.5 mm**

700 V DC

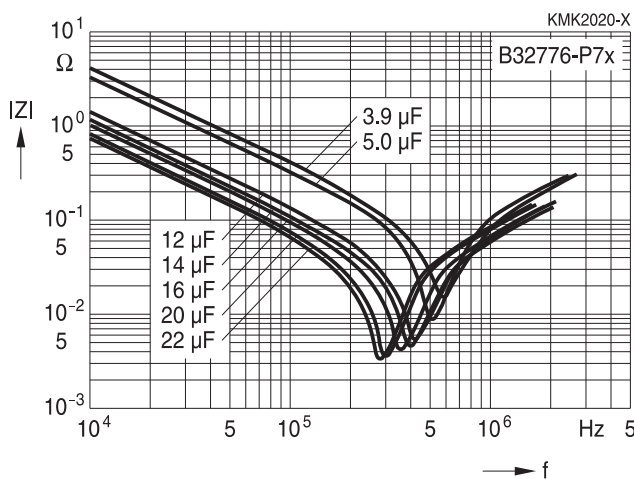

**ESR versus frequency f**  
(typical values)

**Lead spacing 37.5 mm**

700 V DC

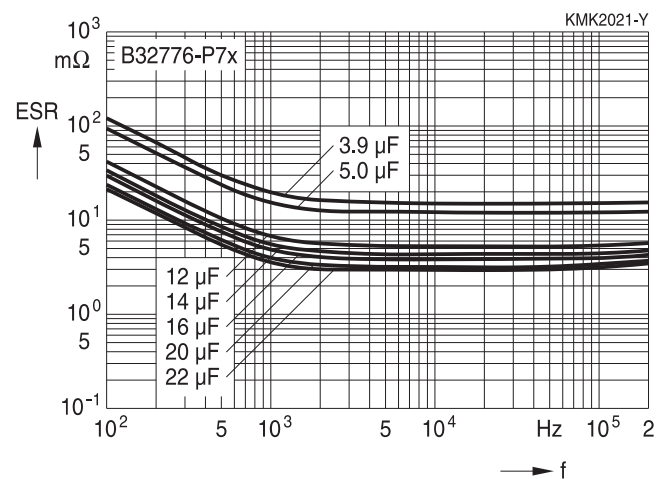



**B32776P**

**MKP DC link – 125 °C series up to 50  $\mu$ F**

**Characteristics curves**

Additional technical information can be found under "Design support" on [www.epcos.com](http://www.epcos.com).

**Impedance Z versus frequency f**  
(typical values)

**Lead spacing 37.5 mm**

840 V DC

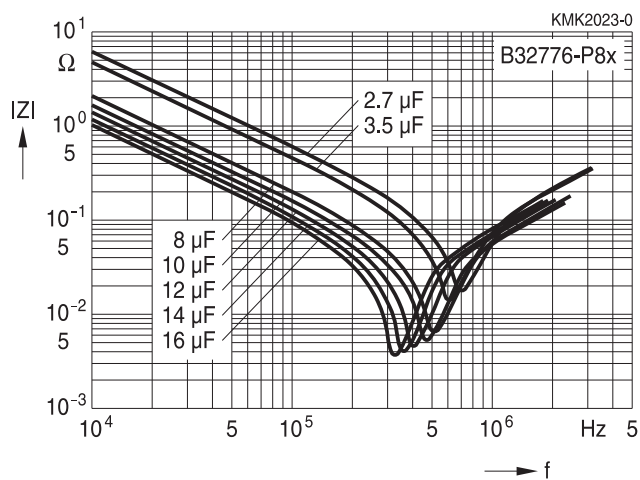

**ESR versus frequency f**  
(typical values)

**Lead spacing 37.5 mm**

840 V DC

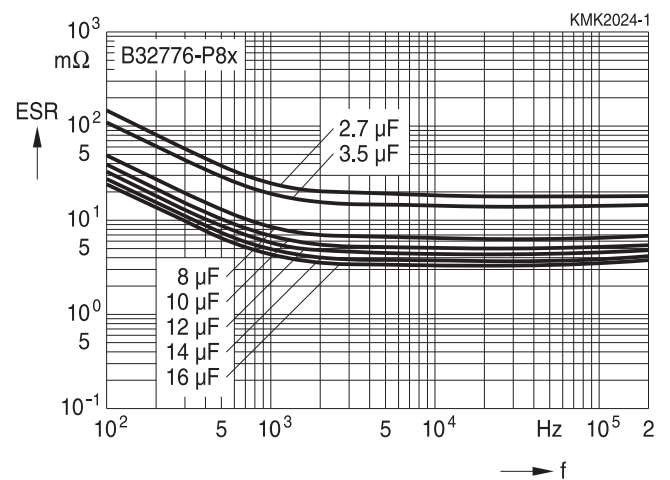



### Characteristics curves

Additional technical information can be found under "Design support" on [www.epcos.com](http://www.epcos.com).

#### Impedance Z versus frequency f (typical values)

Lead spacing 52.5 mm

630 V DC

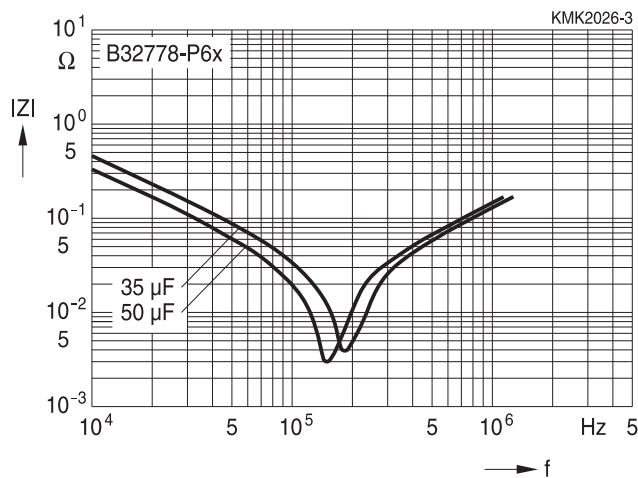

#### ESR versus frequency f (typical values)

Lead spacing 52.5 mm

630 V DC

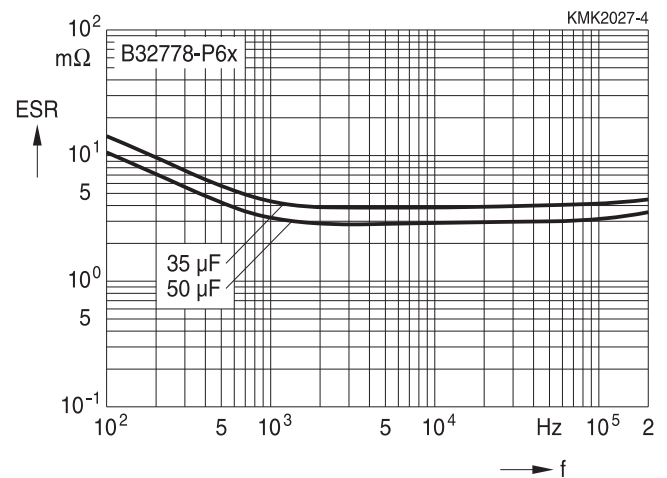

#### Impedance Z versus frequency f (typical values)

Lead spacing 52.5 mm

700 V DC

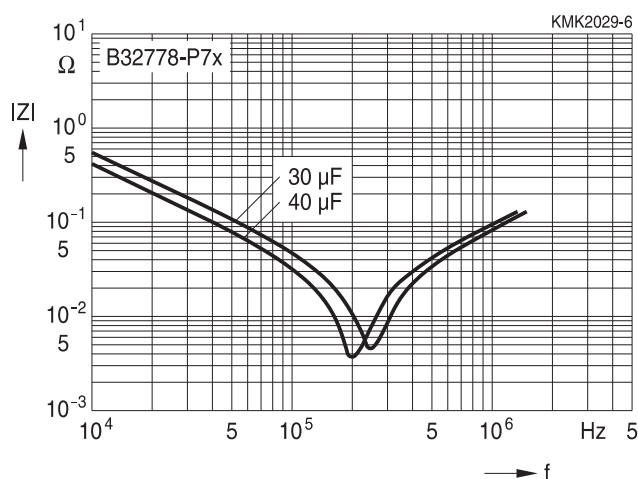

#### ESR versus frequency f (typical values)

Lead spacing 52.5 mm

700 V DC

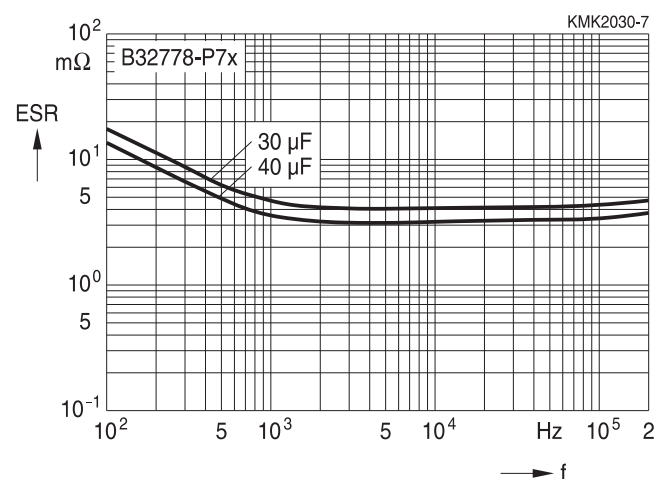



**B32778P**

**MKP DC link – 125 °C series up to 50  $\mu$ F**

**Characteristics curves**

Additional technical information can be found under "Design support" on [www.epcos.com](http://www.epcos.com).

**Impedance Z versus frequency f**  
(typical values)

**Lead spacing 52.5 mm**

840 V DC

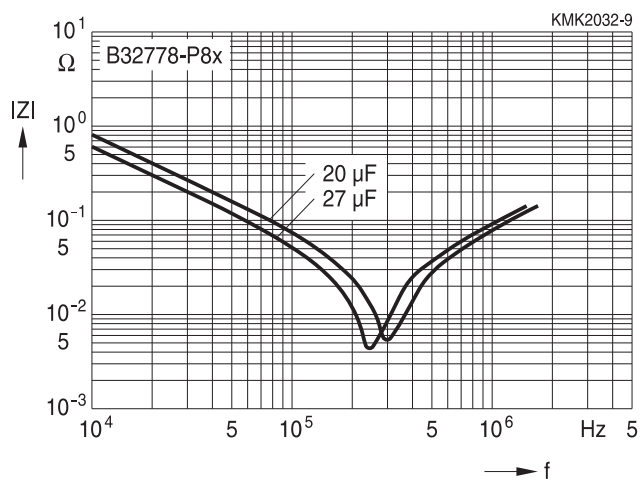

**ESR versus frequency f**  
(typical values)

**Lead spacing 52.5 mm**

840 V DC

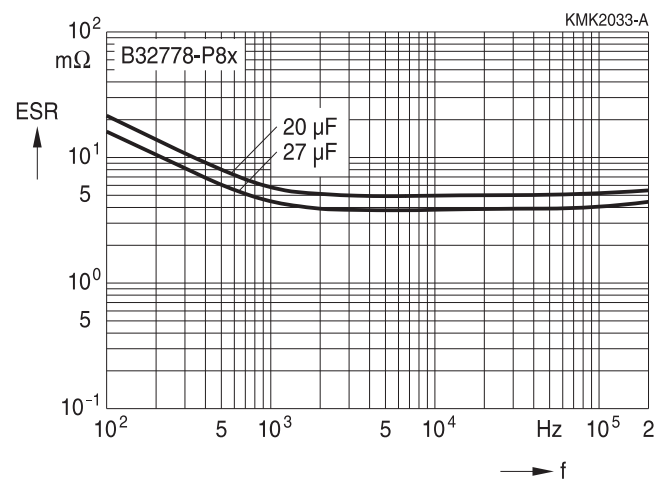





**Characteristics curves**

**Permissible current  $I_{RMS}$  versus frequency  $f$  (for sinusoidal waveforms,  $T_A \leq 85\text{ °C}$ )**

For  $T_A > 85\text{ °C}$ , please use derating factor  $F_T$ .

**Lead spacing 27.5 mm**

**630 V DC**

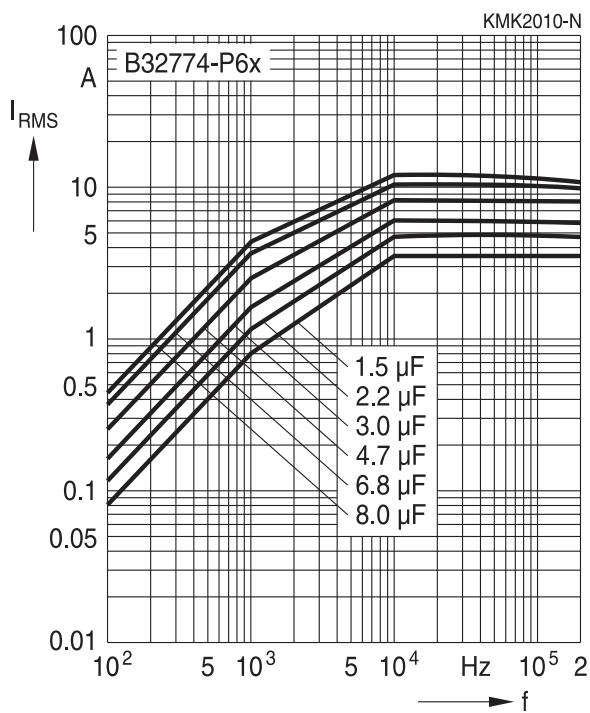

**700 V DC**

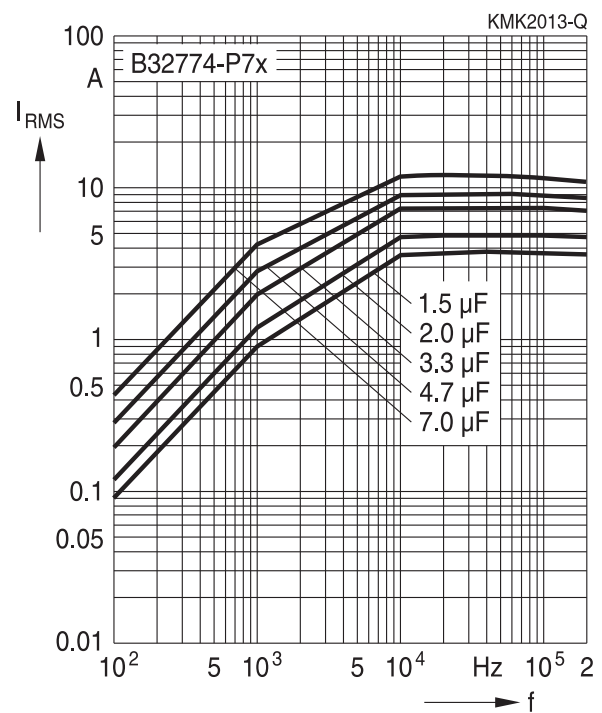

**840 V DC**

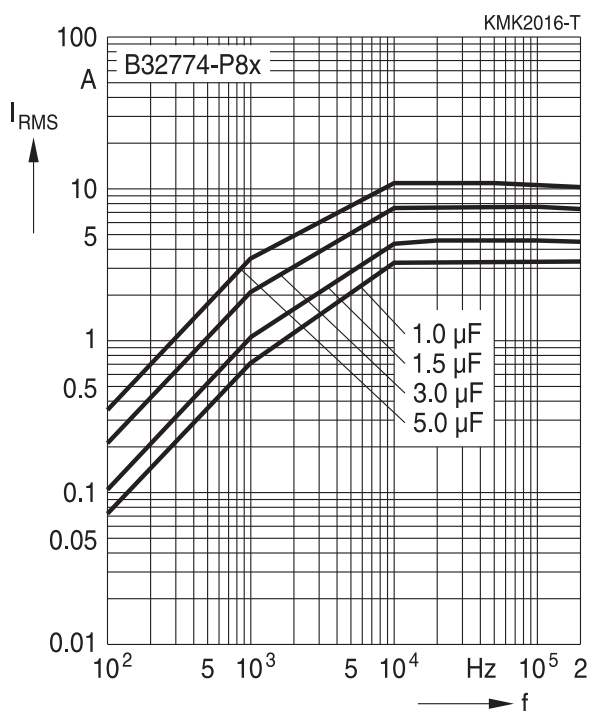



**B32776P**

**MKP DC link – 125 °C series up to 50 µF**

**Characteristics curves**

**Permissible current  $I_{RMS}$  versus frequency  $f$  (for sinusoidal waveforms,  $T_A \leq 85\text{ °C}$ )**

For  $T_A > 85\text{ °C}$ , please use derating factor  $F_T$ .

**Lead spacing 37.5 mm**

630 V DC

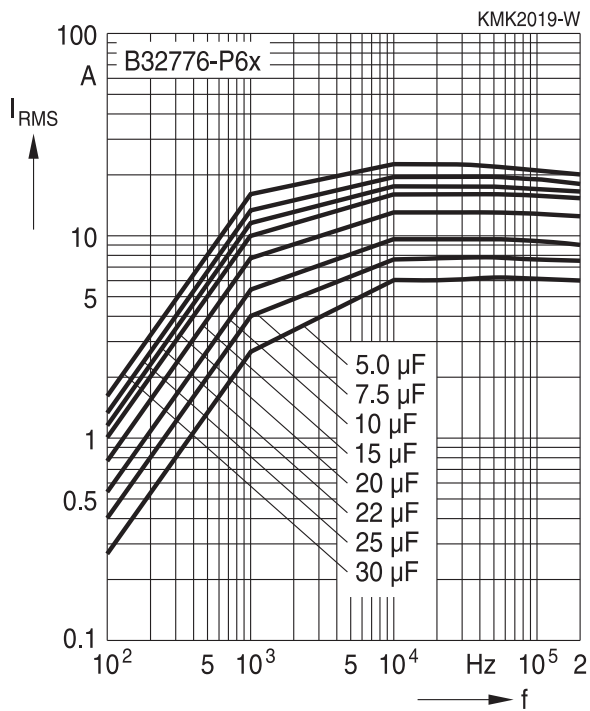

700 V DC

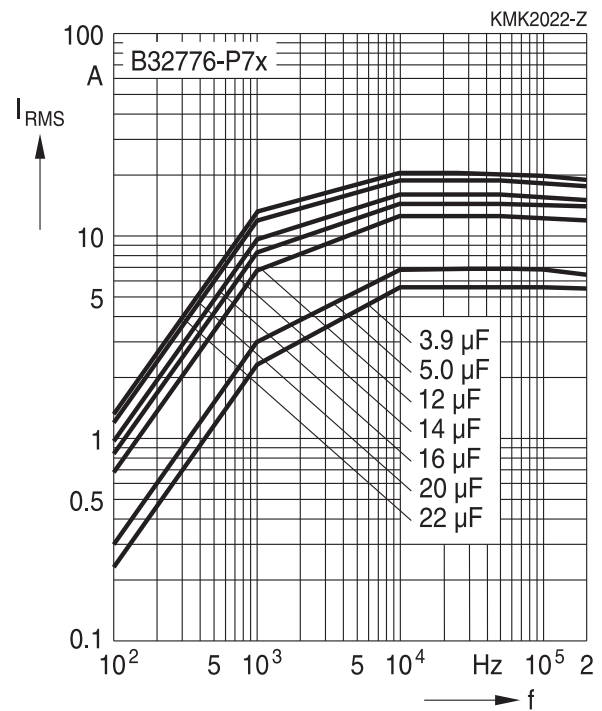

840 V DC

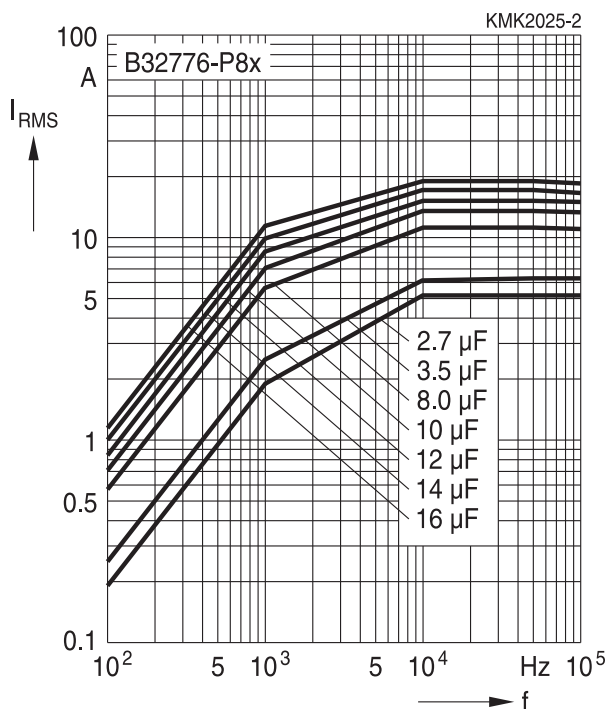

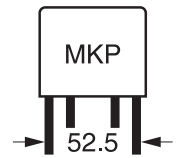

**Characteristics curves**

**Permissible current  $I_{RMS}$  versus frequency  $f$  (for sinusoidal waveforms,  $T_A \leq 85\text{ °C}$ )**

For  $T_A > 85\text{ °C}$ , please use derating factor  $F_T$ .

**Lead spacing 52.5 mm**

**630 V DC**

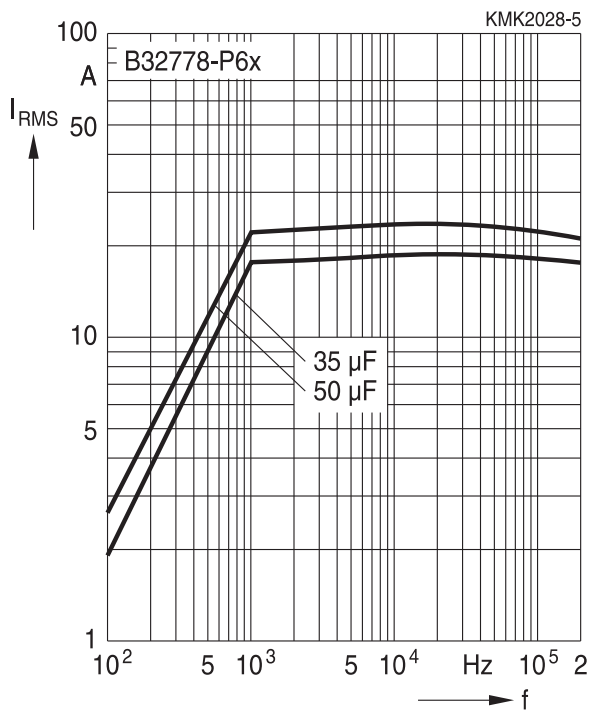

**700 V DC**

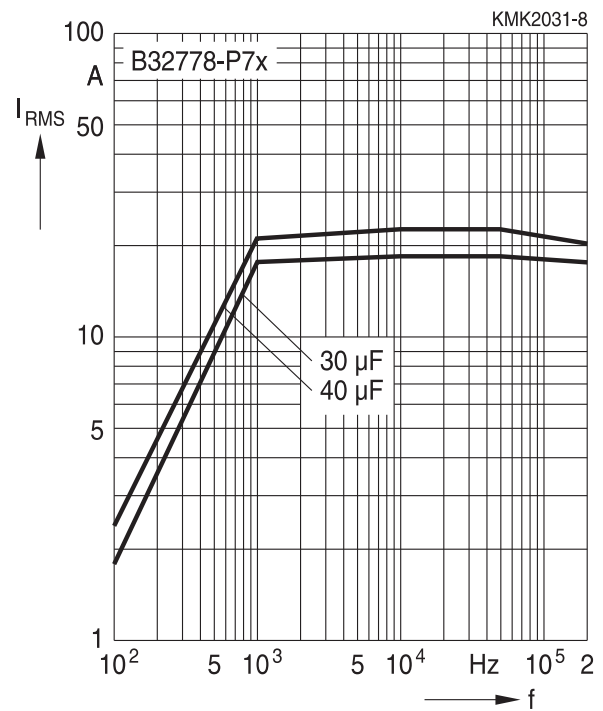

**840 V DC**

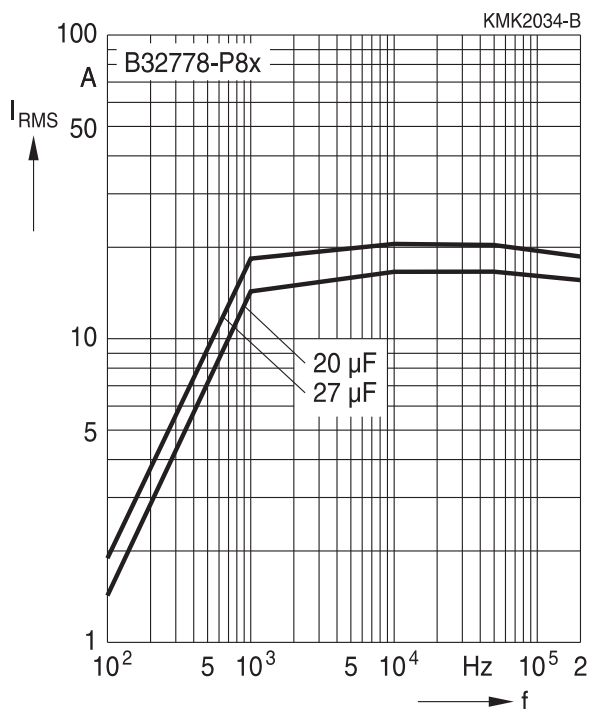



B32774P ... B32778P

MKP DC link – 125 °C series up to 50 µF

**Curves characteristics ( $I_{RMS}$  derating versus temperature)**

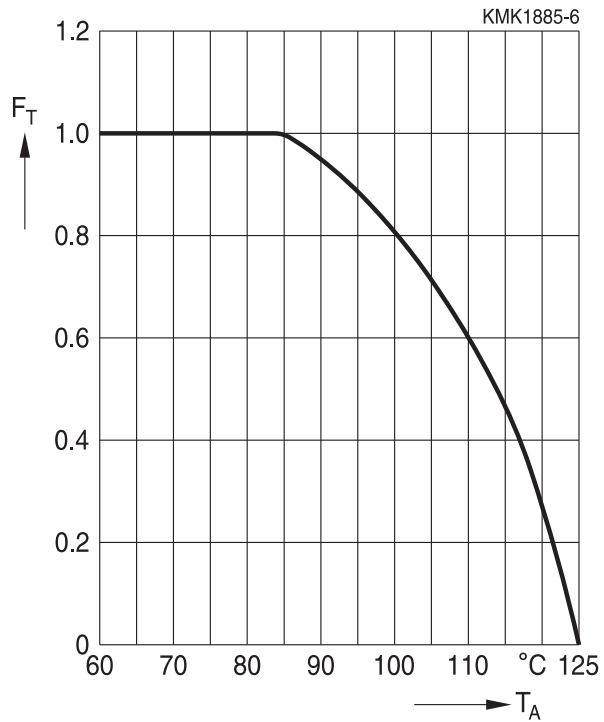

Maximum  $I_{RMS}$  current as function of the ambient temperature:  $I_{RMS}(T_A) = F_T \times I_{RMS}(85\text{ °C})$

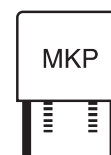

### Heat transference for self heating calculation

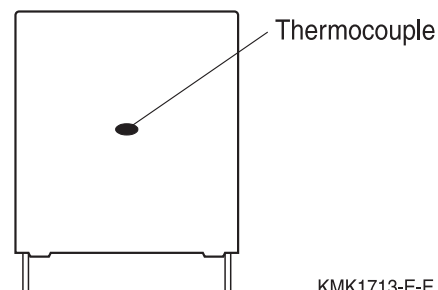

Figure 1

KMK1713-E-E

Box dimensions			Equivalent heat coefficient
w (mm)	h (mm)	l (mm)	G (mW/°C)
11.0	19.0	31.5	25
11.0	21.0	31.5	28
12.5	21.5	31.5	30
13.5	23.0	31.5	32
14.0	24.5	31.5	35
15.0	24.5	31.5	36
16.0	32.0	31.5	45
18.0	27.5	31.5	44
18.0	33.0	31.5	48
19.0	30.0	31.5	48
21.0	31.0	31.5	51
22.0	36.5	31.5	58
12.0	22.0	42.0	70
14.0	25.0	42.0	43
16.0	28.5	42.0	50
18.0	32.5	42.0	59
20.0	39.5	42.0	72
24.0	19.0	42.0	50
24.0	15.0	42.0	44
28.0	37.0	42.0	83
28.0	42.5	42.0	90
30.0	45.0	42.0	100
33.0	48.0	42.0	110
30.0	45.0	57.5	125
35.0	50.0	57.5	145

The equivalent heat coefficient "**G (mW/°C)**" is given for measuring the temperature on the lateral surface of the plastic box as figure1 shows. By using a thermocouple and avoiding effect of radiation and convection the temperature measured during operation conditions should be a result of the dissipated power divided by the equivalent heat coefficient.



B32774P ... B32778P

MKP DC link – 125 °C series up to 50 µF

### Self heating by power dissipation and equivalent heat coefficient

The  $I_{RMS}$  and consequently the power dissipation must be limited during operation in order to not exceed the maximum limit of  $\Delta T$  allowed for this series.  $\Delta T_{max}$  given for this series is equal or lower than 15 °C at rated temperature (85 °C), for higher ambient temperatures  $\Delta T_{max}(T)$  will have the same derating factor than  $I_{RMS}$  versus temperature and then an equivalent derating as per:

$$\Delta T_{max}(T) = (\text{Factor})^2 \times \Delta T(85\text{ °C}).$$

For any particular  $I_{RMS}$  the  $\Delta T$  may be calculated by:

$$\Delta T(\text{°C}) = P_{dis}(\text{mW}) / G(\text{mW/°C}).$$

Where  $\Delta T(\text{°C})$  is the difference between the temperature measured on the box (see figure 1) and the ambient temperature when capacitor is working during normal operation;

$$\Delta T(\text{°C}) = T_{op}(\text{°C}) - T_A(\text{°C}).$$

It represents the increasing of temperature provoked by the  $I_{RMS}$  during operation.

$G(\text{mW/°C})$  is the equivalent heat coefficient described above and  $P_{dis}(\text{mW})$  is the dissipated power defined by:

$$P_{dis}(\text{mW}) = ESR_{typ}(\text{m}\Omega) \times I_{RMS}^2(\text{A}_{RMS}).$$

### Example for thermal calculation:

We will take as reference B32778P6506K (50 µF/630 V DC) type for thermal calculation. Considering the following load and capacitor characteristics:

$I_{RMS}$ : 15  $A_{RMS}$  at 20 kHz

$T_A$ : 100 °C

35 × 50 × 57.5 box

$G(\text{mW/°C})$ : 145

Then we have to find the  $ESR_{typ}$  at 20 kHz what is approximately 2.9 mΩ.

So according to  $P_{dis}(\text{mW}) = ESR_{typ}(\text{m}\Omega) \times I_{RMS}^2(\text{A}_{RMS})$

we have the following:  $P_{dis}(\text{mW}) = 2.9\text{ m}\Omega \times 10\text{ A}_{RMS}^2 = 290\text{ mW}.$

And as per  $\Delta T(\text{°C}) = P_{dis}(\text{mW}) / G(\text{mW/°C})$

we have the following:  $\Delta T(\text{°C}) = 290(\text{mW}) / 145(\text{mW/°C}) = 2.0\text{ °C}.$

What is below of the  $\Delta T_{max}(100\text{ °C}) = (\text{Factor})^2 \times \Delta T(85\text{ °C}) = (0.80)^2 \times 15\text{ °C} = 9.6\text{ °C}.$

On the other hand we may confirm that max  $I_{RMS}$  at 20 kHz at 85 °C = 23.5  $A_{RMS}$ .

And then max  $I_{RMS}$  for 85 °C of ambient temperature is defined as follows:

$$I_{RMS}(100\text{ °C}) = \text{Factor} \times I_{RMS}(85\text{ °C}) = 0.80 \times 23.5\text{ A}_{RMS} = 18.8\text{ A}_{RMS}.$$

What confirms once again that  $I_{RMS}$  (10  $A_{RMS}$  at 20 kHz at 100 °C) is below the max specified for such frequency and ambient temperature.

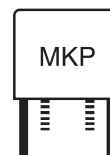

### Service life

#### Life time expectancy - typical curve

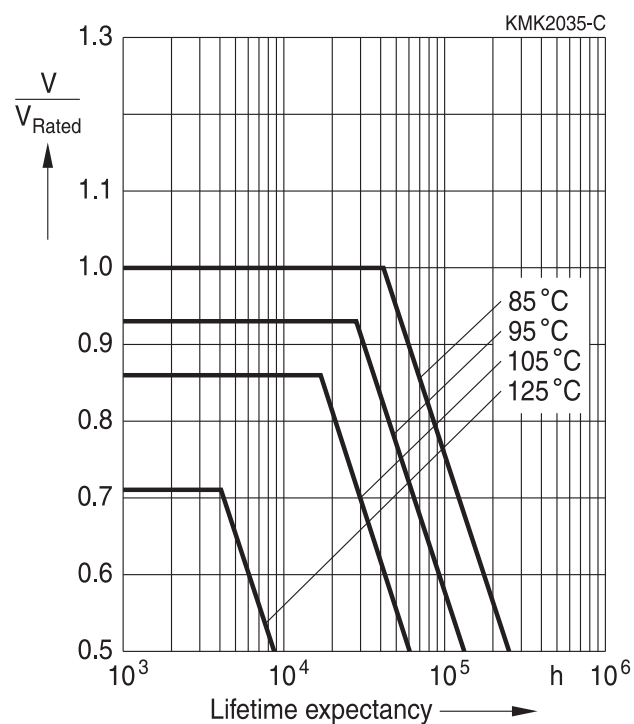

Note:

- (1) Confidence level of 98%
- (2) Life expectancy is given as a function of operating temperature (capacitor body temperature).



B32774P ... B32778P

MKP DC link – 125 °C series up to 50 µF

## Testing and Standards

Test	Reference	Conditions of test	Performance requirements
Electrical parameters (Routine test)	IEC61071:2007	Voltage between terminals, 1.5 V <sub>R</sub> , during 10 s Insulation resistance, R <sub>ins</sub> at 500 V Capacitance, C at 1 kHz (room temperature) Dissipation factor, tan δ at 1/10 kHz (room temperature)	Within specified limits
Robustness of terminations (Type test)	IEC 60068-2-21:2006	Tensile strength (test Ua1) Wire diameter   Tensile force 0.5 < d <sub>1</sub> ≤ 0.8 mm   10 N 0.8 < d <sub>1</sub> ≤ 1.25 mm   20 N	Capacitance and tan δ within specified limits
Resistance to soldering heat (Type test)	IEC 60068-2-20:2008, test Tb, method 1A	Solder bath temperature at 260 ±5 °C, immersion for 10 seconds	ΔC/C <sub>0</sub>   ≤ 2%  Δ tan δ  ≤ 0.002
Bump (Type test)	IEC 60384-16:2005	Test Eb: Total 4000 bumps with 390 m/s <sup>2</sup> mounted on PCB 6 ms duration	No visible damage  ΔC/C <sub>0</sub>   ≤ 2%  Δ tan δ  ≤ 0.002 R <sub>ins</sub> ≥ 50% of initial limit
Climatic sequence (Type test)	IEC 60384-16:2005	Dry heat Tb / 16 h Damp heat cyclic, 1 <sup>st</sup> cycle +55 °C / 24 h / 95% ... 100% RH Cold Ta / 2 h Damp heat cyclic, 5 cycles +55 °C / 24 h / 95% ... 100% RH	No visible damage  ΔC/C <sub>0</sub>   ≤ 3%  Δ tan δ  ≤ 0.001 R <sub>ins</sub> ≥ 50% of initial limit
Thermal shock	AEC-Q200D	–55 °C ... +85 °C, 1000 cycles	No visible damage  ΔC/C <sub>0</sub>   ≤ 2%  Δ tan δ  ≤ 0.002 (1kHz) R <sub>ins</sub> ≥ 50% of initial limit
Vibration	AEC-Q200D	5 g for 20 minutes, 12 cycles, each of 3 orientations (X, Y, Z axis), 240 min/axis, total 12 hours Test from 10-2000 Hz	No visible damage





Test	Reference	Conditions of test	Performance requirements
Advanced humidity test	AEC-Q200D	40 °C / 93% RH / 1000 hours with $V_R$ 60 °C / 95% RH / 500 hours with $V_R$	No visible damage $ \Delta C/C_0  \leq 5\%$ $ \Delta \tan \delta / \tan \delta  \leq 400\%$ (1 kHz) $R_{ins} \geq 50\%$ of initial limit
		$V_R = 630$ : 85 °C / 85% RH / 1000 hours with 450 V DC $V_R = 700$ : 85 °C / 85% RH / 1000 hours with 500 V DC $V_R = 840$ : 85 °C / 85% RH / 1000 hours with 600 V DC	$ \Delta C/C_0  \leq 5\%$ $ \Delta \tan \delta  \leq 0.005$ (1kHz) $R_{ins} \geq 50\%$ of initial limit
En-durance (Type test)	IEC 60384-16:2005	85 °C / 1.25 $V_R$ / 1000 hours or 105 °C / 1.25 $V_{op}$ / 1000 hours or 125 °C / 1.25 $V_{op}$ / 1000 hours	No visible damage $ \Delta C/C_0  \leq 5\%$ $ \Delta \tan \delta  \leq 0.005$ (1 kHz) $R_{ins} \geq 50\%$ of initial limit

## Mounting guidelines

### 1 Soldering

#### 1.1 Solderability of leads

The solderability of terminal leads is tested to IEC 60068-2-20, test Ta, method 1.

Before a solderability test is carried out, terminals are subjected to accelerated ageing (to IEC 60068-2-2, test Ba: 4 h exposure to dry heat at 155 °C). Since the ageing temperature is far higher than the upper category temperature of the capacitors, the terminal wires should be cut off from the capacitor before the ageing procedure to prevent the solderability being impaired by the products of any capacitor decomposition that might occur.

Solder bath temperature	235 ±5 °C
Soldering time	2.0 ±0.5 s
Immersion depth	2.0 +0/−0.5 mm from capacitor body or seating plane
Evaluation criteria:	
Visual inspection	Wetting of wire surface by new solder ≥90%, free-flowing solder



**B32774P ... B32778P**

**MKP DC link – 125 °C series up to 50 µF**

## 1.2 Resistance to soldering heat

Resistance to soldering heat is tested to IEC 60068-2-20, test Tb, method 1.

Conditions:

Series	Solder bath temperature	Soldering time
MKT boxed (except 2.5 × 6.5 × 7.2 mm) coated uncoated (lead spacing >10 mm)	260 ±5 °C	10 ±1 s
MFP MKP (lead spacing >7.5 mm)		
MKT boxed (case 2.5 × 6.5 × 7.2 mm)		
MKP (lead spacing ≤7.5 mm) MKT uncoated (lead spacing ≤10 mm) insulated (B32559)		5 ±1 s  <4 s recommended soldering profile for MKT uncoated (lead spacing ≤ 10 mm) and insulated (B32559)

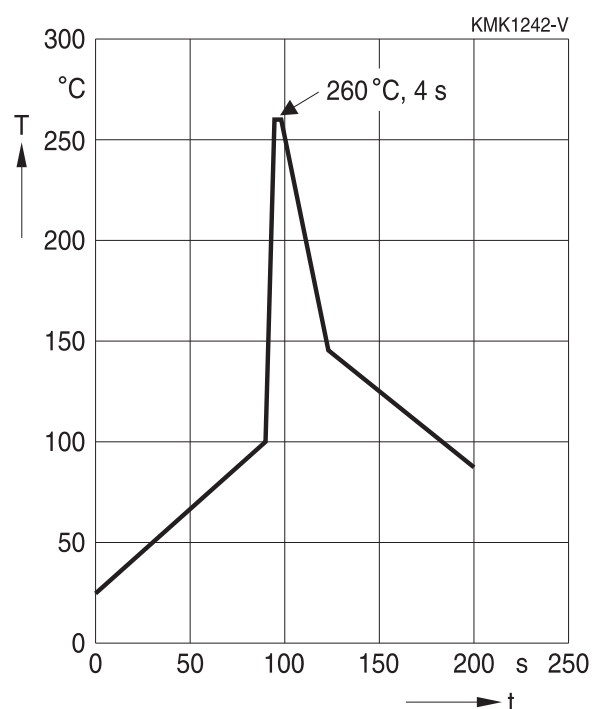

Immersion depth	2.0 +0/−0.5 mm from capacitor body or seating plane
Shield	Heat-absorbing board, (1.5 ±0.5) mm thick, between capacitor body and liquid solder
Evaluation criteria:	
Visual inspection	No visible damage
$\Delta C/C_0$	2% for MKT/MKP/MFP 5% for EMI suppression capacitors
$\tan \delta$	As specified in sectional specification

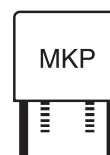

### 1.3 General notes on soldering

Permissible heat exposure loads on film capacitors are primarily characterized by the upper category temperature  $T_{max}$ . Long exposure to temperatures above this type-related temperature limit can lead to changes in the plastic dielectric and thus change irreversibly a capacitor's electrical characteristics. For short exposures (as in practical soldering processes) the heat load (and thus the possible effects on a capacitor) will also depend on other factors like:

- Pre-heating temperature and time
- Forced cooling immediately after soldering
- Terminal characteristics:  
diameter, length, thermal resistance, special configurations (e.g. crimping)
- Height of capacitor above solder bath
- Shadowing by neighboring components
- Additional heating due to heat dissipation by neighboring components
- Use of solder-resist coatings

The overheating associated with some of these factors can usually be reduced by suitable countermeasures. For example, if a pre-heating step cannot be avoided, an additional or reinforced cooling process may possibly have to be included.

### Recommendations

As a reference, the recommended wave soldering profile for our film capacitors is as follows:

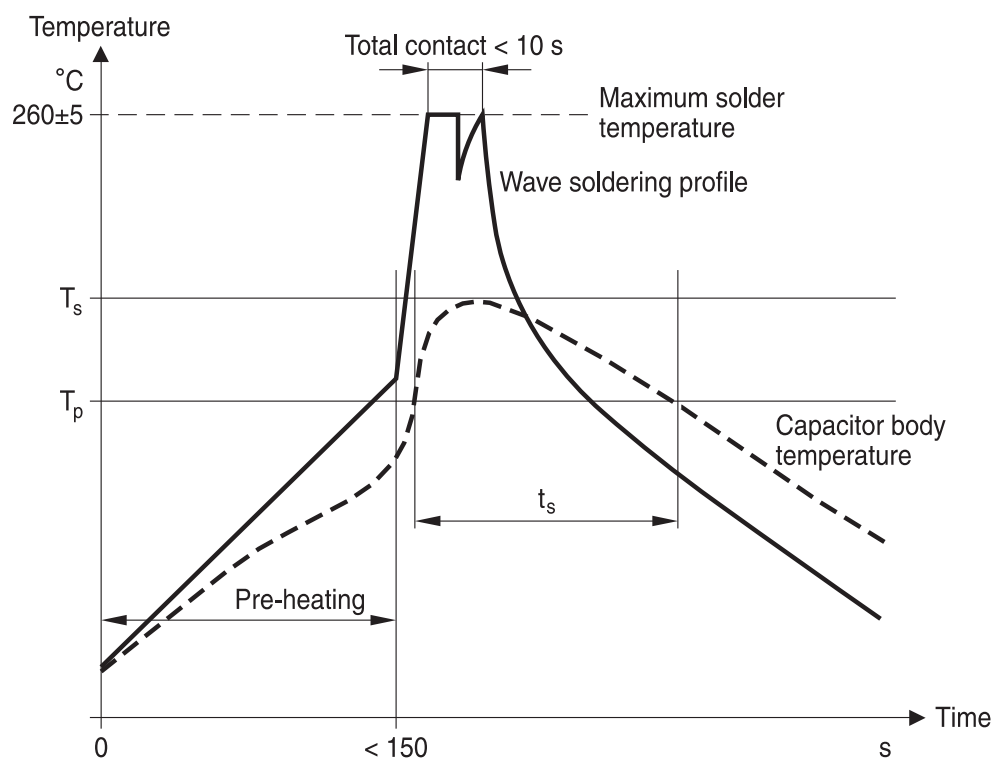

$T_s$ : Capacitor body maximum temperature at wave soldering

$T_p$ : Capacitor body maximum temperature at pre-heating

KMK1745-A-E



**B32774P ... B32778P**

**MKP DC link – 125 °C series up to 50 µF**



Body temperature should follow the description below:

- MKP capacitor
  - During pre-heating:  $T_p \leq 110 \text{ °C}$
  - During soldering:  $T_s \leq 120 \text{ °C}$ ,  $t_s \leq 45 \text{ s}$
- MKT capacitor
  - During pre-heating:  $T_p \leq 125 \text{ °C}$
  - During soldering:  $T_s \leq 160 \text{ °C}$ ,  $t_s \leq 45 \text{ s}$

When SMD components are used together with leaded ones, the film capacitors should not pass into the SMD adhesive curing oven. The leaded components should be assembled after the SMD curing step.

Leaded film capacitors are not suitable for reflow soldering.

In order to ensure proper conditions for manual or selective soldering, the body temperature of the capacitor ( $T_s$ ) must be  $\leq 120 \text{ °C}$ .

One recommended condition for manual soldering is that the tip of the soldering iron should be  $< 360 \text{ °C}$  and the soldering contact time should be no longer than 3 seconds.

For uncoated MKT capacitors with lead spacings  $\leq 10 \text{ mm}$  (B32560/B32561) the following measures are recommended:

- pre-heating to not more than  $110 \text{ °C}$  in the preheater phase
- rapid cooling after soldering

Please refer to our Film Capacitors Data Book in case more details are needed.

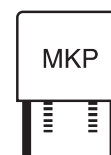

## Cautions and warnings

- Do not exceed the upper category temperature (UCT).
- Do not apply any mechanical stress to the capacitor terminals.
- Avoid any compressive, tensile or flexural stress.
- Do not move the capacitor after it has been soldered to the PC board.
- Do not pick up the PC board by the soldered capacitor.
- Do not place the capacitor on a PC board whose PTH hole spacing differs from the specified lead spacing.
- Do not exceed the specified time or temperature limits during soldering.
- Avoid external energy inputs, such as fire or electricity.
- Avoid overload of the capacitors.
- Consult us if application is with severe temperature and humidity condition.
- There are no serviceable or repairable parts inside the capacitor. Opening the capacitor or any attempts to open or repair the capacitor will void the warranty and liability of TDK Electronics.
- Please note that the standards referred to in this publication may have been revised in the meantime.

The table below summarizes the safety instructions that must always be observed. A detailed description can be found in the relevant sections of the chapters "General technical information" and "Mounting guidelines".

Topic	Safety information	Reference chapter "General technical information"
Storage conditions	Make sure that capacitors are stored within the specified range of time, temperature and humidity conditions.	4.5 "Storage conditions"
Flammability	Avoid external energy, such as fire or electricity (passive flammability), avoid overload of the capacitors (active flammability) and consider the flammability of materials.	5.3 "Flammability"
Resistance to vibration	Do not exceed the tested ability to withstand vibration. The capacitors are tested to IEC 60068-2-6:2007. TDK Electronics offers film capacitors specially designed for operation under more severe vibration regimes such as those found in automotive applications. Consult our catalog "Film Capacitors for Automotive Electronics".	5.2 "Resistance to vibration"



**B32774P ... B32778P**

**MKP DC link – 125 °C series up to 50 µF**

Topic	Safety information	Reference chapter "Mounting guidelines"
Soldering	Do not exceed the specified time or temperature limits during soldering.	1 "Soldering"
Cleaning	Use only suitable solvents for cleaning capacitors.	2 "Cleaning"
Embedding of capacitors in finished assemblies	When embedding finished circuit assemblies in plastic resins, chemical and thermal influences must be taken into account. Caution: Consult us first, if you also wish to embed other uncoated component types!	3 "Embedding of capacitors in finished assemblies"

### Display of ordering codes for TDK Electronics products

The ordering code for one and the same product can be represented differently in data sheets, data books, other publications, on the company website, or in order-related documents such as shipping notes, order confirmations and product labels. The varying representations of the ordering codes are due to different processes employed and do not affect the specifications of the respective products.

Detailed information can be found on the Internet under [www.tdk-electronics.tdk.com/orderingcodes](http://www.tdk-electronics.tdk.com/orderingcodes).

### Correlation of data sheet values and modelling tool outputs

Data sheet values and results of design tools may deviate as they have not been derived in the same context.

While data sheets show individual parameter statements without considering a possible dependency to other parameters. Tools model a complete given scenario as input and processed inside the tool.

Furthermore as we constantly strive to improve our models, the results of tools can change over time and be a non-binding indication only.



## Symbols and terms

Symbol	English	German
$\alpha$	Heat transfer coefficient	Wärmeübergangszahl
$\alpha_C$	Temperature coefficient of capacitance	Temperaturkoeffizient der Kapazität
A	Capacitor surface area	Kondensatoroberfläche
$\beta_C$	Humidity coefficient of capacitance	Feuchtekoeffizient der Kapazität
C	Capacitance	Kapazität
$C_R$	Rated capacitance	Nennkapazität
$\Delta C$	Absolute capacitance change	Absolute Kapazitätsänderung
$\Delta C/C$	Relative capacitance change (relative deviation of actual value)	Relative Kapazitätsänderung (relative Abweichung vom Ist-Wert)
$\Delta C/C_R$	Capacitance tolerance (relative deviation from rated capacitance)	Kapazitätstoleranz (relative Abweichung vom Nennwert)
dt	Time differential	Differentielle Zeit
$\Delta t$	Time interval	Zeitintervall
$\Delta T$	Absolute temperature change (self-heating)	Absolute Temperaturänderung (Selbsterwärmung)
$\Delta \tan \delta$	Absolute change of dissipation factor	Absolute Änderung des Verlustfaktors
$\Delta V$	Absolute voltage change	Absolute Spannungsänderung
dV/dt	Time differential of voltage function (rate of voltage rise)	Differentielle Spannungsänderung (Spannungsflankensteilheit)
$\Delta V/\Delta t$	Voltage change per time interval	Spannungsänderung pro Zeitintervall
E	Activation energy for diffusion	Aktivierungsenergie zur Diffusion
ESL	Self-inductance	Eigeninduktivität
ESR	Equivalent series resistance	Ersatz-Serienwiderstand
f	Frequency	Frequenz
$f_1$	Frequency limit for reducing permissible AC voltage due to thermal limits	Grenzfrequenz für thermisch bedingte Reduzierung der zulässigen Wechselspannung
$f_2$	Frequency limit for reducing permissible AC voltage due to current limit	Grenzfrequenz für strombedingte Reduzierung der zulässigen Wechselspannung
$f_r$	Resonant frequency	Resonanzfrequenz
$F_D$	Thermal acceleration factor for diffusion	Therm. Beschleunigungsfaktor zur Diffusion
$F_T$	Derating factor	Deratingfaktor
i	Current (peak)	Stromspitze
$I_C$	Category current (max. continuous current)	Kategoriestrom (max. Dauerstrom)



**B32774P ... B32778P**

**MKP DC link – 125 °C series up to 50 µF**

Symbol	English	German
$I_{RMS}$	(Sinusoidal) alternating current, root-mean-square value	(Sinusförmiger) Wechselstrom
$i_z$	Capacitance drift	Inkonstanz der Kapazität
$k_0$	Pulse characteristic	Impuls Kennwert
$L_S$	Series inductance	Serieninduktivität
$\lambda$	Failure rate	Ausfallrate
$\lambda_0$	Constant failure rate during useful service life	Konstante Ausfallrate in der Nutzungsphase
$\lambda_{test}$	Failure rate, determined by tests	Experimentell ermittelte Ausfallrate
$P_{diss}$	Dissipated power	Abgegebene Verlustleistung
$P_{gen}$	Generated power	Erzeugte Verlustleistung
$Q$	Heat energy	Wärmeenergie
$\rho$	Density of water vapor in air	Dichte von Wasserdampf in Luft
$R$	Universal molar constant for gases	Allg. Molarkonstante für Gas
$R$	Ohmic resistance of discharge circuit	Ohmscher Widerstand des Entladekreises
$R_i$	Internal resistance	Innenwiderstand
$R_{ins}$	Insulation resistance	Isolationswiderstand
$R_P$	Parallel resistance	Parallelwiderstand
$R_S$	Series resistance	Serienwiderstand
$S$	severity (humidity test)	Schärfegrad (Feuchtetest)
$t$	Time	Zeit
$T$	Temperature	Temperatur
$\tau$	Time constant	Zeitkonstante
$\tan \delta$	Dissipation factor	Verlustfaktor
$\tan \delta_D$	Dielectric component of dissipation factor	Dielektrischer Anteil des Verlustfaktors
$\tan \delta_P$	Parallel component of dissipation factor	Parallelanteil des Verlustfaktors
$\tan \delta_S$	Series component of dissipation factor	Serienanteil des Verlustfaktors
$T_A$	Temperature of the air surrounding the component	Temperatur der Luft, die das Bauteil umgibt
$T_{max}$	Upper category temperature	Obere Kategorietemperatur
$T_{min}$	Lower category temperature	Untere Kategorietemperatur
$t_{OL}$	Operating life at operating temperature and voltage	Betriebszeit bei Betriebstemperatur und -spannung
$T_{op}$	Operating temperature, $T_A + \Delta T$	Betriebstemperatur, $T_A + \Delta T$
$T_R$	Rated temperature	Nenntemperatur
$T_{ref}$	Reference temperature	Referenztemperatur
$t_{SL}$	Reference service life	Referenz-Lebensdauer





Symbol	English	German
$V_{AC}$	AC voltage	Wechselspannung
$V_C$	Category voltage	Kategorie <span>spannung</span>
$V_{C,RMS}$	Category AC voltage	(Sinusförmige) Kategorie-Wechselspannung
$V_{CD}$	Corona-discharge onset voltage	Teilentlade-Einsatzspannung
$V_{ch}$	Charging voltage	Ladespannung
$V_{DC}$	DC voltage	Gleichspannung
$V_{FB}$	Fly-back capacitor voltage	Spannung (Flyback)
$V_i$	Input voltage	Eingangsspannung
$V_o$	Output voltage	Ausgangsspannung
$V_{op}$	Operating voltage	Betriebsspannung
$V_p$	Peak pulse voltage	Impuls-Spitzen <span>spannung</span>
$V_{pp}$	Peak-to-peak voltage Impedance	Spannungshub
$V_R$	Rated voltage	Nennspannung
$\hat{V}_R$	Amplitude of rated AC voltage	Amplitude der Nenn-Wechsel <span>spannung</span>
$V_{RMS}$	(Sinusoidal) alternating voltage, root-mean-square value	(Sinusförmige) Wechsel <span>spannung</span>
$V_{SC}$	S-correction voltage	Spannung bei Anwendung "S-correction"
$V_{sn}$	Snubber capacitor voltage	Spannung bei Anwendung "Beschaltung"
$Z$	Impedance	Scheinwiderstand
$e$	Lead spacing	Rastermaß

## Important notes

The following applies to all products named in this publication:

1. Some parts of this publication contain **statements about the suitability of our products for certain areas of application**. These statements are based on our knowledge of typical requirements that are often placed on our products in the areas of application concerned. We nevertheless expressly point out **that such statements cannot be regarded as binding statements about the suitability of our products for a particular customer application**. As a rule, we are either unfamiliar with individual customer applications or less familiar with them than the customers themselves. For these reasons, it is always ultimately incumbent on the customer to check and decide whether a product with the properties described in the product specification is suitable for use in a particular customer application.
2. We also point out that **in individual cases, a malfunction of electronic components or failure before the end of their usual service life cannot be completely ruled out in the current state of the art, even if they are operated as specified**. In customer applications requiring a very high level of operational safety and especially in customer applications in which the malfunction or failure of an electronic component could endanger human life or health (e.g. in accident prevention or lifesaving systems), it must therefore be ensured by means of suitable design of the customer application or other action taken by the customer (e.g. installation of protective circuitry or redundancy) that no injury or damage is sustained by third parties in the event of malfunction or failure of an electronic component.
3. **The warnings, cautions and product-specific notes must be observed.**
4. In order to satisfy certain technical requirements, **some of the products described in this publication may contain substances subject to restrictions in certain jurisdictions (e.g. because they are classed as hazardous)**. Useful information on this will be found in our Material Data Sheets on the Internet ([www.tdk-electronics.tdk.com/material](http://www.tdk-electronics.tdk.com/material)). Should you have any more detailed questions, please contact our sales offices.
5. We constantly strive to improve our products. Consequently, **the products described in this publication may change from time to time**. The same is true of the corresponding product specifications. Please check therefore to what extent product descriptions and specifications contained in this publication are still applicable before or when you place an order. We also **reserve the right to discontinue production and delivery of products**. Consequently, we cannot guarantee that all products named in this publication will always be available. The aforementioned does not apply in the case of individual agreements deviating from the foregoing for customer-specific products.
6. Unless otherwise agreed in individual contracts, **all orders are subject to our General Terms and Conditions of Supply**.

## Important notes

7. **Our manufacturing sites serving the automotive business apply the IATF 16949 standard.** The IATF certifications confirm our compliance with requirements regarding the quality management system in the automotive industry. Referring to customer requirements and customer specific requirements (“CSR”) TDK always has and will continue to have the policy of respecting individual agreements. Even if IATF 16949 may appear to support the acceptance of unilateral requirements, we hereby like to emphasize that **only requirements mutually agreed upon can and will be implemented in our Quality Management System.** For clarification purposes we like to point out that obligations from IATF 16949 shall only become legally binding if individually agreed upon.
8. The trade names EPCOS, CarXield, CeraCharge, CeraDiode, CeraLink, CeraPad, CeraPlas, CSMP, CTVS, DeltaCap, DigiSiMic, ExoCore, FilterCap, FormFit, LeaXield, MiniBlue, MiniCell, MKD, MKK, ModCap, MotorCap, PCC, PhaseCap, PhaseCube, PhaseMod, PhiCap, PowerHap, PQSine, PQvar, SIFERRIT, SIFI, SIKOREL, SilverCap, SIMDAD, SiMic, SIMID, SineFormer, SIOV, ThermoFuse, WindCap, XieldCap are **trademarks registered or pending** in Europe and in other countries. Further information will be found on the Internet at [www.tdk-electronics.tdk.com/trademarks](http://www.tdk-electronics.tdk.com/trademarks).

Release 2020-06