

BZT52C2V0-HF Thru. BZT52C75-HF

RoHS Device
Halogen Free

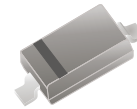

Features

- Large selection of zener voltages: 2V~75V.
- Tight voltage tolerance: $\pm 5\%$ for C-series.
- Ultra low-profile package well suited for automated assembly.
- MSL class 1 compatible.

Mechanical data

- Case: Molded plastic, SOD-123

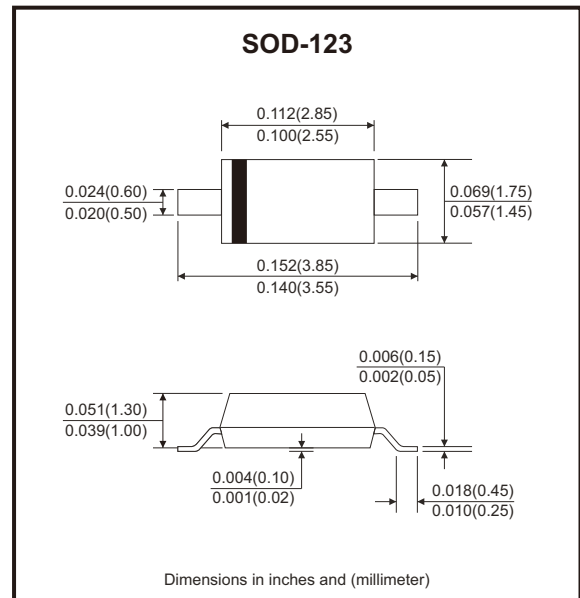

Circuit Diagram



Maximum Ratings ($T_A=25^\circ\text{C}$ unless otherwise noted)

Parameter	Symbol	Value	Unit
Forward voltage @ $I_F=10\text{mA}$	V_F	0.9	V
Power dissipation (collector)	P_C	500	mW
Thermal resistance, junction to ambient	$R_{\theta JA}$	250	$^\circ\text{C/W}$
Thermal resistance, junction to case	$R_{\theta JC}$	140	$^\circ\text{C/W}$
Junction temperature range	T_J	-55 to +150	$^\circ\text{C}$
Storage temperature range	T_{STG}	-65 to +150	$^\circ\text{C}$

Note: 1. These ratings are limiting values above which the serviceability of the diodes may be impaired.

Electrical Characteristics (TA=25°C unless otherwise noted)

Part Number	Zener Voltage				Maximum Zener Impedance			Temperature Coefficient @ I _{ZT}		Maximum Reverse Current I _R @ V _R		Marking Code
	V _Z @ I _{ZT}			I _{ZT}	Z _{ZT} @I _{ZT}	Z _{ZK} @I _{ZK}	I _{ZK}	T _c (mV/°C)		I _R (μA)	V _R (V)	
	Min(V)	Typ(V)	Max(V)	(mA)	(Ω)	(Ω)	(mA)	Min.	Max.			
BZT52C2V0-HF	1.90	2.0	2.10	5.0	100	600	1.0	-3.5	0	150	1.0	WY
BZT52C2V2-HF	2.09	2.2	2.31	5.0	100	600	1.0	-3.5	0	150	1.0	22•
BZT52C2V4-HF	2.20	2.4	2.60	5.0	100	600	1.0	-3.5	0	50	1.0	WX
BZT52C2V7-HF	2.50	2.7	2.90	5.0	100	600	1.0	-3.5	0	20	1.0	W1
BZT52C3V0-HF	2.80	3.0	3.20	5.0	95	600	1.0	-3.5	0	10	1.0	W2
BZT52C3V3-HF	3.10	3.3	3.50	5.0	95	600	1.0	-3.5	0	5.0	1.0	W3
BZT52C3V6-HF	3.40	3.6	3.80	5.0	90	600	1.0	-3.5	0	5.0	1.0	W4
BZT52C3V9-HF	3.70	3.9	4.10	5.0	90	600	1.0	-3.5	0	3.0	1.0	W5
BZT52C4V3-HF	4.00	4.3	4.60	5.0	90	600	1.0	-3.5	0	3.0	1.0	W6
BZT52C4V7-HF	4.40	4.7	5.00	5.0	80	500	1.0	-3.5	0	3.0	2.0	W7
BZT52C5V1-HF	4.80	5.1	5.40	5.0	60	480	1.0	-2.7	1.2	2.0	2.0	W8
BZT52C5V6-HF	5.20	5.6	6.00	5.0	40	400	1.0	-2.0	2.5	1.0	2.0	W9
BZT52C6V2-HF	5.80	6.2	6.60	5.0	10	150	1.0	0.4	3.7	3.0	4.0	WA
BZT52C6V8-HF	6.40	6.8	7.14	5.0	15	80	1.0	1.2	4.5	2.0	4.0	WB
BZT52C7V5-HF	7.00	7.5	7.90	5.0	15	80	1.0	2.5	5.3	1.0	5.0	WC
BZT52C8V2-HF	7.70	8.2	8.70	5.0	15	80	1.0	3.2	6.2	0.7	5.0	WD
BZT52C9V1-HF	8.50	9.1	9.60	5.0	15	100	1.0	3.8	7.0	0.5	6.0	WE
BZT52C10-HF	9.40	10	10.60	5.0	20	150	1.0	4.5	8.0	0.2	7.0	WF
BZT52C11-HF	10.40	11	11.60	5.0	20	150	1.0	5.4	9.0	0.1	8.0	WG
BZT52C12-HF	11.40	12	12.70	5.0	25	150	1.0	6.0	10.0	0.1	8.0	WH
BZT52C13-HF	12.40	13	14.10	5.0	30	170	1.0	7.0	11.0	0.1	8.0	WI
BZT52C15-HF	13.80	15	15.60	5.0	30	200	1.0	9.2	13.0	0.1	10.5	WJ
BZT52C16-HF	15.30	16	17.10	5.0	40	200	1.0	10.4	14.0	0.1	11.2	WK
BZT52C18-HF	16.80	18	19.10	5.0	45	225	1.0	12.4	16.0	0.1	12.6	WL
BZT52C20-HF	18.80	20	21.20	5.0	55	225	1.0	14.4	18.0	0.1	14.0	WM
BZT52C22-HF	20.80	22	23.30	5.0	55	250	1.0	16.4	20.0	0.1	15.4	WN
BZT52C24-HF	22.80	24	25.60	5.0	70	250	1.0	18.4	22.0	0.1	16.8	WO
BZT52C27-HF	25.10	27	28.90	2.0	80	300	0.5	21.4	25.3	0.1	18.9	WP
BZT52C30-HF	28.00	30	32.00	2.0	80	300	0.5	24.4	29.4	0.1	21.0	WQ
BZT52C33-HF	31.00	33	35.00	2.0	80	325	0.5	27.4	33.4	0.1	23.1	WR

Company reserves the right to improve product design , functions and reliability without notice. REV:A

Electrical Characteristics (TA=25°C unless otherwise noted)

Part Number	Zener Voltage			Maximum Zener Impedance			Temperature Coefficient @ I _{ZT} T _c (mV/°C)		Maximum Reverse Current I _R @ V _R		Marking Code	
	V _Z @ I _{ZT}			I _{ZT}	Z _{ZT} @I _{ZT}	Z _{ZK} @I _{ZK}	I _{ZK}	Min.	Max.	(μA)		(V)
	Min(V)	Typ(V)	Max(V)	(mA)	(Ω)	(Ω)	(mA)					
BZT52C36-HF	34.00	36	38.00	2.0	90	350	0.5	30.4	37.4	0.1	25.2	WS
BZT52C39-HF	37.00	39	41.00	2.0	130	350	0.5	33.4	41.2	0.1	27.3	WT
BZT52C43-HF	40.00	43	46.00	2.0	100	700	1.0	10.0	12.0	0.1	32.0	WU
BZT52C47-HF	44.00	47	50.00	2.0	100	750	1.0	10.0	12.0	0.1	35.0	WV
BZT52C51-HF	48.00	51	54.00	2.0	100	750	1.0	10.0	12.0	0.1	38.0	WW
BZT52C56-HF	53.20	56	58.80	2.0	200	400	0.5	10.0	12.0	0.045	39.2	WX•
BZT52C62-HF	58.90	62	65.10	2.0	215	423	0.5	10.0	12.0	0.045	43.4	6E
BZT52C68-HF	64.60	68	71.40	2.0	240	447	0.5	10.0	12.0	0.045	47.6	6F
BZT52C75-HF	71.25	75	78.75	2.0	255	470	0.5	10.0	12.0	0.045	52.5	6H

Rating and Characteristic Curves (BZT52C2V0-HF Thru. BZT52C75-HF)

Fig.1 - Power Derating Curve

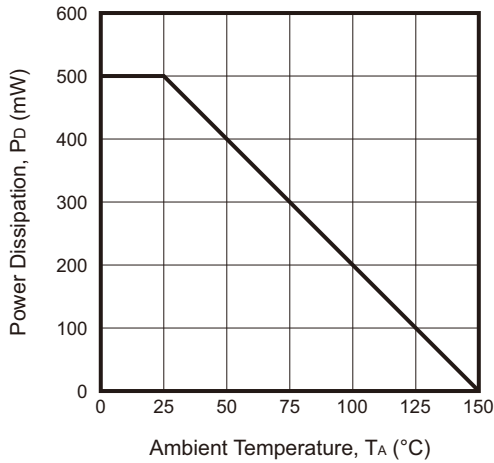

Fig.2 - Typical Zener Breakdown Characteristics

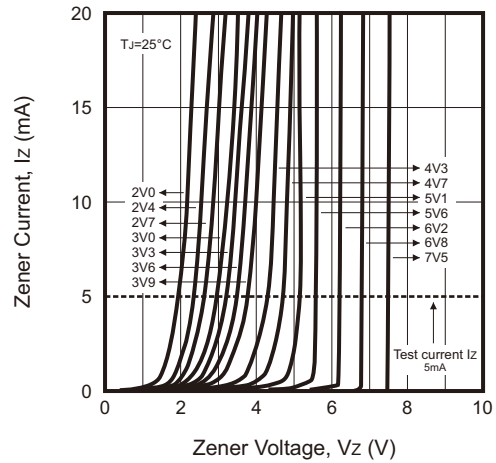

Fig.3 - Typical Zener Breakdown Characteristics

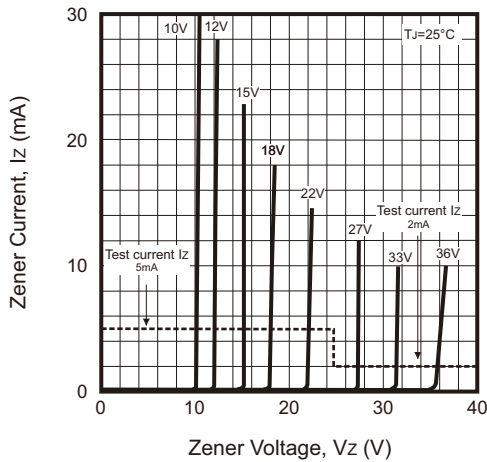

Fig.4 - Typical Zener Breakdown Characteristics

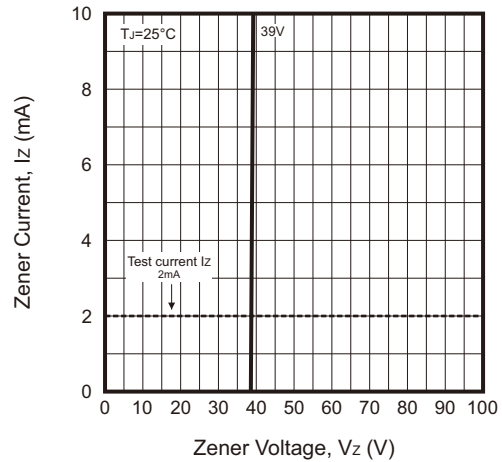

Fig.5 - Typical Temperature Coefficient of Zener Voltage

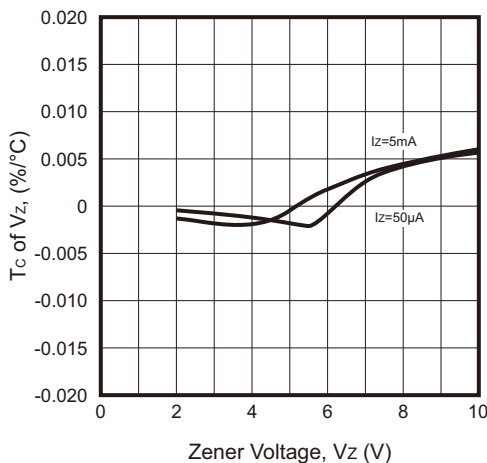
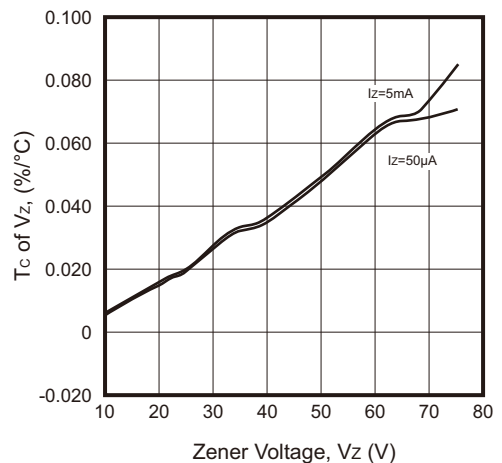

Fig.6 - Typical Temperature Coefficient of Zener Voltage



Company reserves the right to improve product design, functions and reliability without notice.

REV:A

Reel Taping Specification

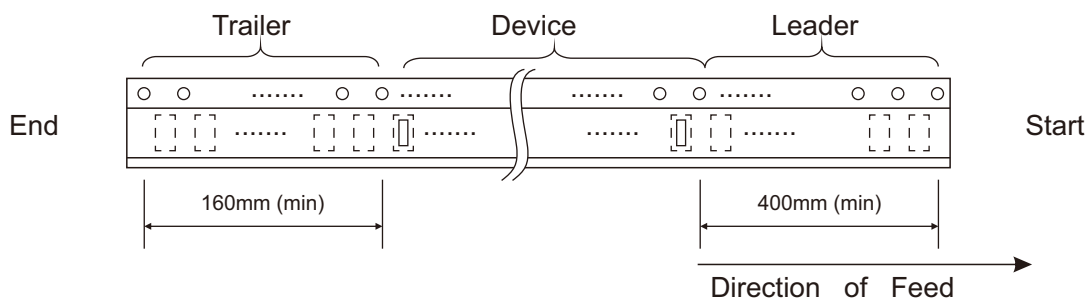
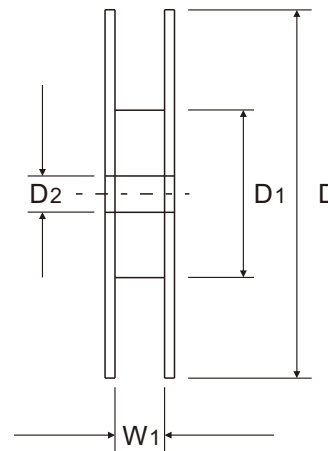
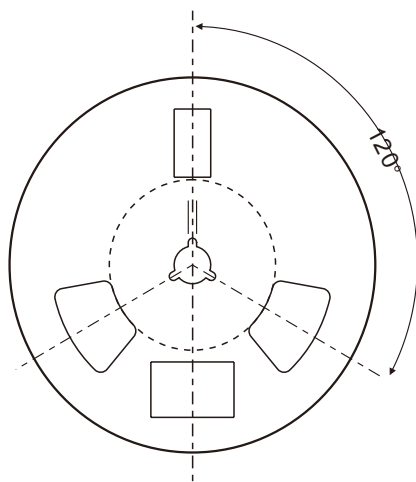
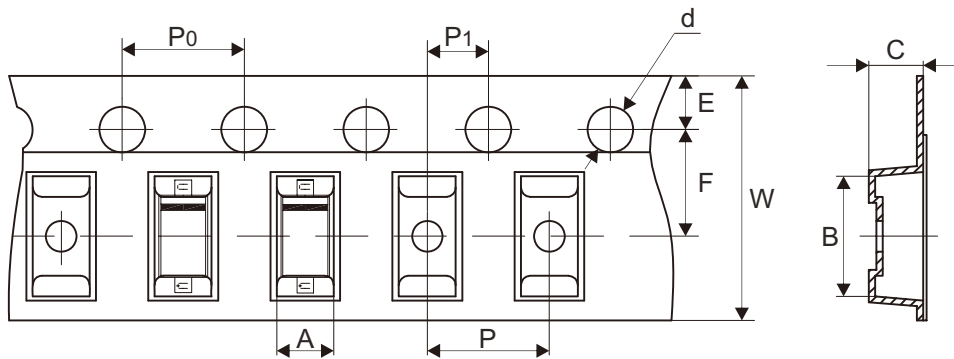

SOD-123	SYMBOL	A	B	C	d	D	D1	D2
	(mm)	1.85 ± 0.10	3.94 ± 0.10	1.57 ± 0.10	1.55 ± 0.05	178.00 ± 1.00	54.00 ± 0.50	13.00 ± 0.50
	(inch)	0.073 ± 0.004	0.155 ± 0.004	0.062 ± 0.004	0.061 ± 0.002	7.008 ± 0.039	2.126 ± 0.020	0.512 ± 0.020

SOD-123	SYMBOL	E	F	P	P1	P0	W	W1
	(mm)	1.75 ± 0.10	3.50 ± 0.05	4.00 ± 0.10	2.00 ± 0.05	4.00 ± 0.10	8.00 + 0.30 - 0.10	9.50 ± 1.00
	(inch)	0.069 ± 0.004	0.138 ± 0.002	0.157 ± 0.004	0.079 ± 0.002	0.157 ± 0.004	0.315 + 0.012 - 0.004	0.374 ± 0.039

Company reserves the right to improve product design, functions and reliability without notice. REV:A

Marking Code

Part Number	Marking Code
BZT52Cxxx-HF series	See Page 2~3



XX/XXX = Product type marking code

█ = Cathode band

Suggested PAD Layout

SIZE	SOD-123	
	(mm)	(inch)
A	2.36	0.093
B	0.91	0.036
C	1.22	0.048
D	4.19	0.165

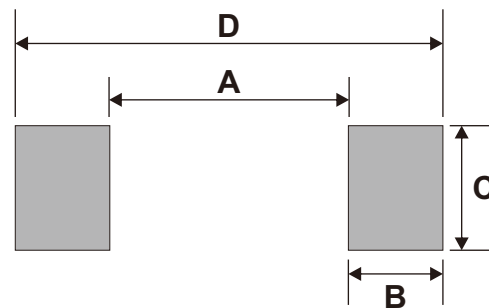

Note: 1.The pad layout is for reference purposes only.

Standard Packaging

Case Type	REEL PACK	
	REEL (pcs)	Reel Size (inch)
SOD-123	3,000	7