



Quality Products. Service Excellence.

EMI/RFI Chokes 1538 Series

Features

- High saturation flux density ferrite rods.
- 1" long leads, tinned to within 1/8" of body.
- Ideal for filtering or energy storage inductors.
- Inductance measured at @ 1Khz. with 0 amps. D.C. current, typical inductance change is less than 5% @ twice rated current.
- Ambient temperature range -60 C to +85 C

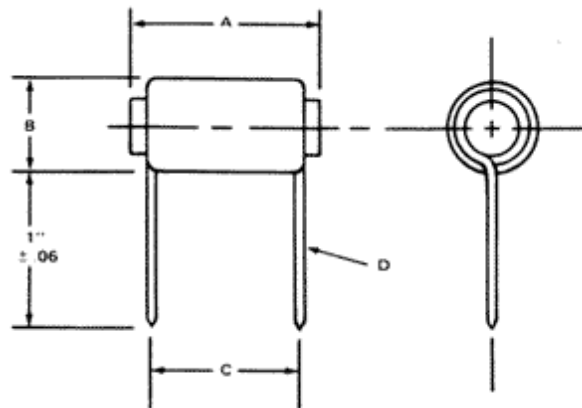

Part No.	Inductance L uH +/- 10%	SRF MHz	R - D.C. Max Ohms	I - D.C. Max Amps	Maximum Dim. A	Maximum Dim. B	Typ. Dim. C	Typ. Dim. D
1538M01	5	32.4	0.013	10	0.88	0.63	0.50	0.04
1538M02	10	21.6	0.017	9	1.12	0.63	0.69	0.04
1538M03	27	5.6	0.03	7	0.88	0.81	0.44	0.04
1538M04	50	3.44	0.04	5.6	0.88	0.81	0.75	0.04
1538M05	100	2.08	0.061	4.9	1.12	0.81	0.94	0.04
1538M06	150	1.84	0.069	4.6	1.38	0.81	1.06	0.04
1538M07	250	1.1	0.089	4	1.62	0.81	1.31	0.04
1538M08	5	27.2	0.009	14	0.88	0.64	0.75	0.05
1538M09	10	21.7	0.012	12	1.12	0.64	1.00	0.05
1538M10	27	5.6	0.022	9	0.88	0.88	0.56	0.05
1538M11	50	4.4	0.028	8	1.12	0.88	0.75	0.05
1538M12	68	3.6	0.034	7.3	1.12	0.88	0.88	0.05
1538M13	100	2.4	0.038	6.8	1.38	0.88	1.00	0.05
1538M14	150	1.6	0.046	6.3	1.62	0.88	1.25	0.05
1538M15	5	34.7	0.006	19	1.12	0.69	0.81	0.07
1538M16	10	20	0.008	16	1.38	0.94	1.22	0.07
1538M17	27	6.2	0.014	12.5	1.12	0.94	0.69	0.07
1538M18	50	3.8	0.02	10.5	1.38	0.94	0.94	0.07

Part No.	Inductance L uH +/- 10%	SRF MHz	R - D.C. Max Ohms	I - D.C. Max Amps	Maximum Dim. A	Maximum Dim. B	Typ. Dim. C	Typ. Dim. D
1538M19	68	3.2	0.023	10	1.38	0.94	1.12	0.07
1538M20	100	2.2	0.027	10	1.62	0.94	1.31	0.07
1538M21	5	30.8	0.004	23	1.38	0.72	0.94	0.08
1538M22	10	20	0.006	20	1.69	0.72	1.50	0.08
1538M23	27	6.4	0.01	15	1.38	1.00	0.94	0.08
1538M24	50	3.5	0.013	15	1.62	1.00	1.12	0.08

Tags: choke, emi, rfi, flux density, ferrite rods, filter, energy storage

Data subject to change without notice

© 2023. Hammond Manufacturing Ltd. All rights reserved.