

LDB, Unencapsulated Stacked Chip, Size 1206 – 1812, 16 VDC and 50 VDC

Overview

Polyphenylene sulphide (PPS) film capacitor for surface mounting.

Applications

Typical applications include timing, filtering, and use as a memory capacitor. The LDB Series is designed for high stability, accuracy, and temperature.

Benefits

- Rated voltage: 16 – 50 VDC
- Capacitance range: 0.0033 – 0.1 μ F
- EIA Size 1206 – 1812
- Capacitance tolerance: \pm 2%, \pm 5%
- Climatic category: 55/125/56
- RoHS compliance and lead-free terminations
- Operating temperature range of -55°C to +125°C

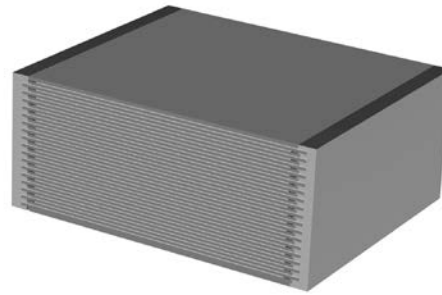

Part Number System

LDB	A	A	2120	G	C	5	N	0
Series	Rated Voltage (VDC)	Size Code	Capacitance Code (pF)	Capacitance Tolerance	Dielectric	Version	Packaging	Internal Use
Metallized PPS	A = 16 C = 50	See Dimension Table	Digits two – four indicate the first three digits of the capacitance value. First digit indicates the number of zeros to be added.	G = \pm 2% J = \pm 5%	C = PPS	5 = Standard	See Ordering Options Table	0 (Standard)

Dimensions – Millimeters

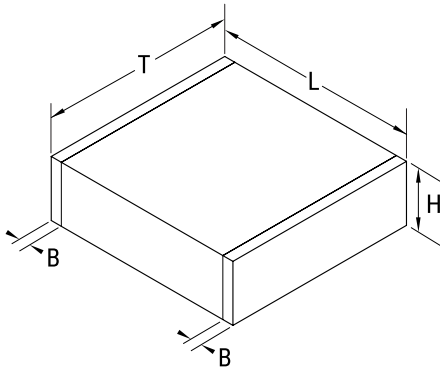

Size Code	Chip Size (EIA)	T		H (Maximum)	L		B	
		Nominal	Tolerance		Nominal	Tolerance	Nominal	Tolerance
A	1206	1.7	±0.2	See Part Number Table	3.3	+0.3/-0.1	0.4	+0.5/-0.3
B	1210	2.5	±0.3		3.3	+0.3/-0.1	0.4	+0.5/-0.3
C	1812	3.3	±0.3		4.7	+0.3/-0.2	0.4	+0.5/-0.3

Landing Areas and Solder Paste Suggestions

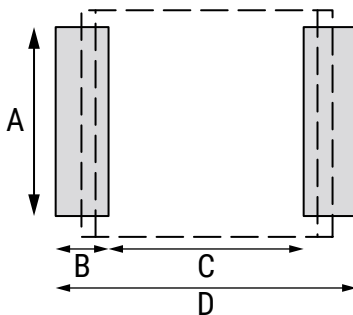

Size	Dimensions in mm				Size	Dimensions in mm			
	A	B	C	D		A	B	C	D
1206	1.5	1.1	2.3	4.5	2824	5.7	2.3	5.3	9.9
1210	2.3	1.1	2.3	4.5	4030	7.4	2.6	8.2	13.4
1812	3.0	1.7	3.1	6.5	5040	9.6	2.6	10.7	15.9
2220	4.6	2.1	3.9	8.1	6054	12.6	2.6	13.2	18.4

These landing area dimensions have the aim of taking full advantage of the new RoHS 6 terminations design.

We suggest to use a Sn/Ag/Cu solder paste (suggested thickness: 0.10 – 0.15 mm).

If a NOT Lead Free solder paste is used, a minimum peak temperature of 210°C on the component's body is suggested.

Ordering Options Table

Packaging Type	Packaging Code
Standard Packaging Options	
Tape & Reel (Standard Reel)	N

Performance Characteristics

Rated Voltage (VDC)	16	50
Capacitance Range (µF)	0.012 – 0.1	0.0033 – 0.1
Chip Size (EIA)	1206 – 1812	
Capacitance Values	E12 series	
Capacitance Tolerance	±2%, ±5%	
Category Temperature Range	-55°C to +125°C	
Rated Temperature	+105°C	
Voltage Derating	V_c (category voltage) = V_R (rated voltage) up to 105°C. V_c should be decreased by 1.25%/°C from +105°C to +125°C	
Climatic Category	55/125/56	
Capacitance Drift	Maximum 1% after a 2 year storage period at a temperature of +10°C to +40°C and a relative humidity of 40% to 60%	
Reliability (Reference MIL-HDBK-217)	Failure rate ≤ 1 FIT, $T = +40^\circ\text{C}$, $V = 0.5 \times V_R$	
	1 FIT = 10^{-9} failures / (components * hours)	
	Failure criteria: open or short circuit, cap. change > 10%, DF 2 times the catalog limits, IR < 0.005 x initial limit	
Insulation Resistance	Measured at +25°C ±5°C	
	Between Terminals	
	3,000 MΩ	
	Charging time: 1 minute Charging voltage: 10 VDC for $V_R = 16$ VDC 50 VDC for $V_R = 50$ VDC	
Dissipation Factor	Maximum Values at 25°C ±5°C	
	1 kHz	0.6%
Surge Voltage Test	1.75 x V_R (5 seconds; $T = 25 \pm 5^\circ\text{C}$)	

PPS Dielectric Typical Temperature Graphs

PPS Dielectric Typical Frequency Graphs

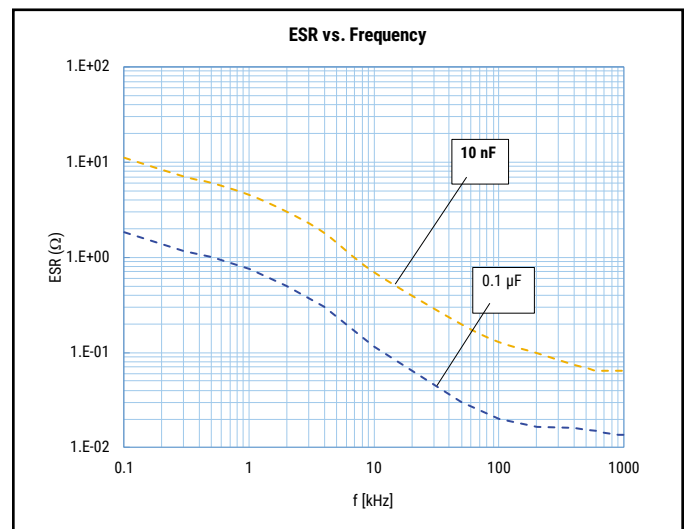
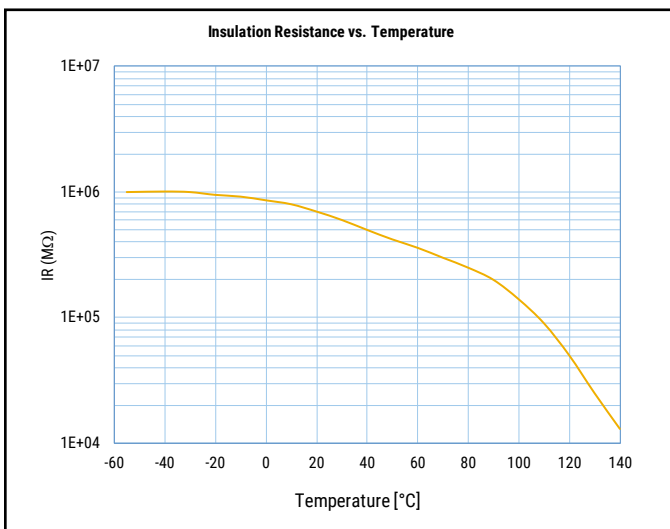
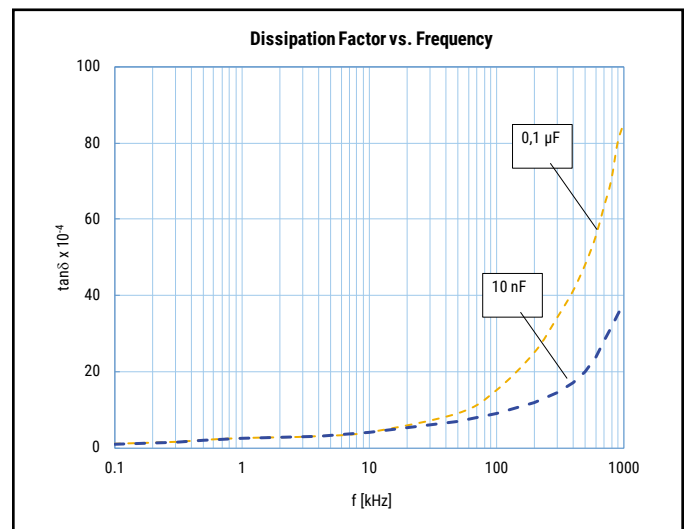
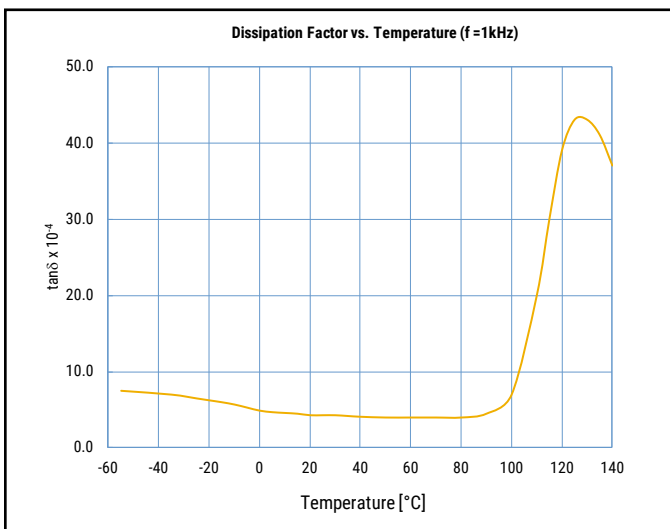
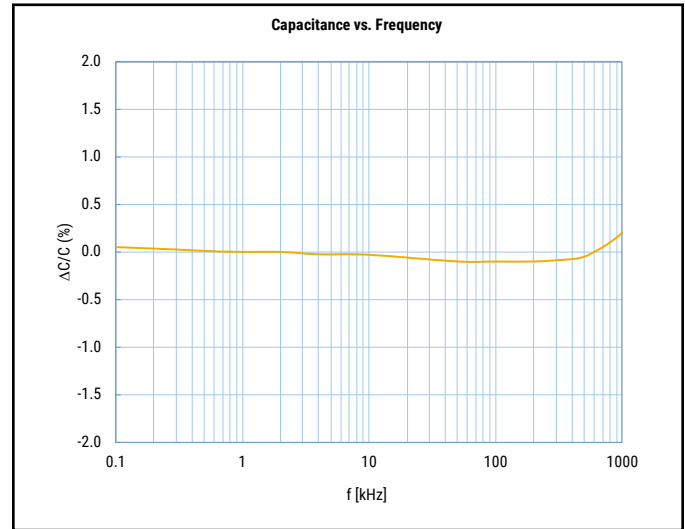
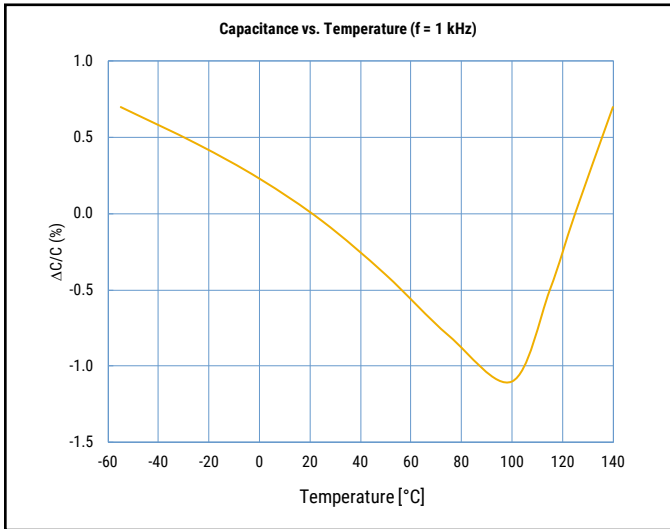

PEN and PPS Impedance vs. Frequency

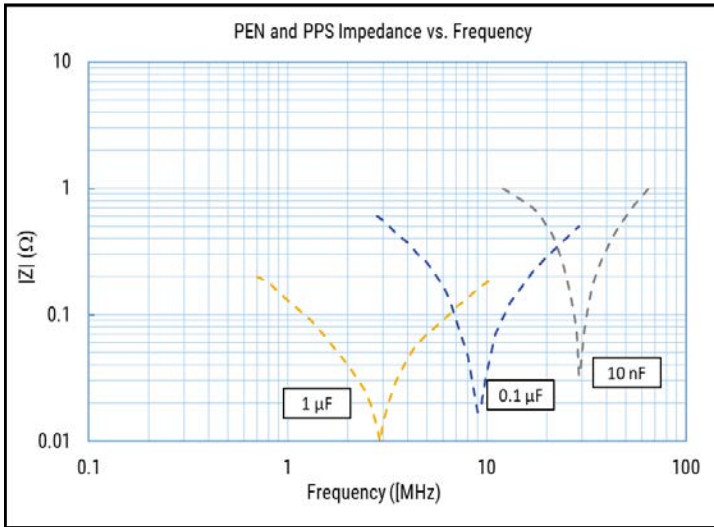

Environmental Compliance

All KEMET surface mount capacitors are RoHS Compliant.



Environmental Test Data

Damp Heat, Steady State	
Test Conditions	
Temperature	+40°C ±2°C
Relative Humidity (RH)	93% ±2%
Test Duration	56 days
Performance	
Capacitance Change Δ C/C	≤ 5%
DF Change (Δtgδ)	≤ 30 x 10 ⁻⁴ at 1 kHz
Insulation Resistance	≥ 50% of limit value
Endurance	
Test Conditions	
Temperature	125°C ±2°C
Test Duration	2,000 hours
Voltage Applied	1.25 x V _C
Performance	
Capacitance Change Δ C/C	≤ 3%
DF Change (Δtgδ)	≤ 30 x 10 ⁻⁴ at 1 kHz
Insulation Resistance	≥ 50% of limit value
Rapid Change of Temperature	
Test Conditions	
Temperature	1 hour at -55°C, 1 hour at +125°C
Number of Cycles	1,000
Performance	
Capacitance Change Δ C/C	≤ 3%
DF Change (Δtgδ)	≤ 50 x 10 ⁻⁴ at 1 kHz
Insulation Resistance	≥ limit value
No Mechanical Damage	

Reflow	
Test Conditions	See Solder Process
Performance	
Capacitance Change Δ C/C	≤ 3%
DF Change (Δtgδ)	≤ 50 x 10 ⁻⁴ at 1 kHz
Insulation Resistance	≥ limit value
No Mechanical Damage	
Bending	
Test Conditions	
Deflection	1 – 6 mm
Performance	
Capacitance Change Δ C/C	≤ 1%
No visible damage on the terminations (peeling) neither on the body (cracking)	

Table 1 – Ratings & Part Number Reference

VDC	Capacitance Value (µF)	Size Code	Dimensions in mm			Chip Size	New KEMET Part Number	Legacy Part Number
			W	H (max)	L			
16	0.012	A	1.7	1.1	3.3	1206	DBAA2120(1)C5N0	LDBAA2120(1)C5N0
16	0.015	A	1.7	1.1	3.3	1206	DBAA2150(1)C5N0	LDBAA2150(1)C5N0
16	0.018	A	1.7	1.1	3.3	1206	DBAA2180(1)C5N0	LDBAA2180(1)C5N0
16	0.022	A	1.7	1.1	3.3	1206	DBAA2220(1)C5N0	LDBAA2220(1)C5N0
16	0.027	A	1.7	1.1	3.3	1206	DBAA2270(1)C5N0	LDBAA2270(1)C5N0
16	0.033	A	1.7	1.1	3.3	1206	DBAA2330(1)C5N0	LDBAA2330(1)C5N0
16	0.039	A	1.7	1.2	3.3	1206	DBAA2390(1)C5N0	LDBAA2390(1)C5N0
16	0.047	A	1.7	1.3	3.3	1206	DBAA2470(1)C5N0	LDBAA2470(1)C5N0
16	0.056	B	2.5	1.7	3.3	1210	DBAB2560(1)C5N0	LDBAB2560(1)C5N0
16	0.068	B	2.5	1.7	3.3	1210	DBAB2680(1)C5N0	LDBAB2680(1)C5N0
16	0.082	B	2.5	1.7	3.3	1210	DBAB2820(1)C5N0	LDBAB2820(1)C5N0
16	0.10	B	2.5	2.0	3.3	1210	DBAB3100(1)C5N0	LDBAB3100(1)C5N0
50	0.0033	A	1.7	1.1	3.3	1206	DBCA1330(1)C5N0	LDBCA1330(1)C5N0
50	0.0039	A	1.7	1.1	3.3	1206	DBCA1390(1)C5N0	LDBCA1390(1)C5N0
50	0.0047	A	1.7	1.1	3.3	1206	DBCA1470(1)C5N0	LDBCA1470(1)C5N0
50	0.0056	A	1.7	1.1	3.3	1206	DBCA1560(1)C5N0	LDBCA1560(1)C5N0
50	0.0068	A	1.7	1.1	3.3	1206	DBCA1680(1)C5N0	LDBCA1680(1)C5N0
50	0.0082	A	1.7	1.1	3.3	1206	DBCA1820(1)C5N0	LDBCA1820(1)C5N0
50	0.010	A	1.7	1.1	3.3	1206	DBCA2100(1)C5N0	LDBCA2100(1)C5N0
50	0.012	A	1.7	1.1	3.3	1206	DBCA2120(1)C5N0	LDBCA2120(1)C5N0
50	0.015	B	2.5	1.4	3.3	1210	DBCB2150(1)C5N0	LDBCB2150(1)C5N0
50	0.018	B	2.5	1.5	3.3	1210	DBCB2180(1)C5N0	LDBCB2180(1)C5N0
50	0.022	B	2.5	1.5	3.3	1210	DBCB2220(1)C5N0	LDBCB2220(1)C5N0
50	0.027	B	2.5	1.5	3.3	1210	DBCB2270(1)C5N0	LDBCB2270(1)C5N0
50	0.033	B	2.5	1.7	3.3	1210	DBCB2330(1)C5N0	LDBCB2330(1)C5N0
50	0.039	B	2.5	1.9	3.3	1210	DBCB2390(1)C5N0	LDBCB2390(1)C5N0
50	0.047	B	2.5	2.3	3.3	1210	DBCB2470(1)C5N0	LDBCB2470(1)C5N0
50	0.056	C	3.3	1.7	4.7	1812	DBCC2560(1)C5N0	LDBCC2560(1)C5N0
50	0.068	C	3.3	1.7	4.7	1812	DBCC2680(1)C5N0	LDBCC2680(1)C5N0
50	0.082	C	3.3	1.7	4.7	1812	DBCC2820(1)C5N0	LDBCC2820(1)C5N0
50	0.10	C	3.3	2.0	4.7	1812	DBCC3100(1)C5N0	LDBCC3100(1)C5N0
VDC	Capacitance Value (µF)	Size Code	W (mm)	H (mm)	L (mm)	Chip Size	New KEMET Part Number	Legacy Part Number

(1) G = ±2%, J = ±5%.

Soldering Process

Reflow Recommendations	
Preheating	
Maximum Preheating Time	180 seconds
Minimum Temperature	150°C
Maximum Temperature	200°C
Solder Flow	
Maximum Time within T_{max} and $T_{max} - 5^{\circ}\text{C}$ (ΔT_5)	30 seconds ($T_{max} \leq 250^{\circ}\text{C}$)
	10 seconds ($250^{\circ}\text{C} < T_{max} \leq 260^{\circ}\text{C}$)
Maximum Time Over 217°C (ΔT_{217})	150 seconds
Maximum Temperature Ramp Rate	3°C/seconds (heating)
	6°C/seconds (cooling)
Second reflow	
If two reflow processes are needed, be sure that before the second reflow, the temperature on the capacitor's surface is lower than 50°C.	

* Maximum Temperature on the component's body (T_{max}): = 260 °C.

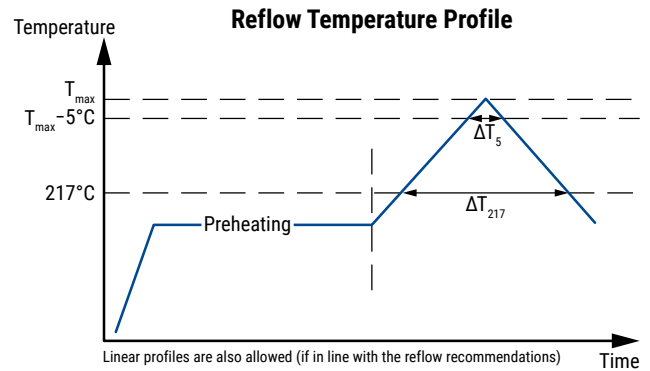

Flux/Cleaning/Storage and Moisture

Flux suggestions

KEMET suggests to use a no-clean flux with a halogen content lower than 0.1%.

Cleaning suggestions

To clean the PCB assembly, KEMET recommends using a suitable solvent like Isopropyl alcohol, deionized water, or neutral pH detergents. Aggressive solvents shall not be used. For any different cleaning solvent used, please contact KEMET Technical Services to analyze the potential impact on KEMET products.

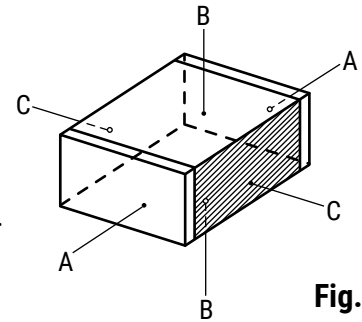

Fig. 1

Storage and moisture recommendations

KEMET SMD Film Capacitors are supplied in a MBB (Moisture Barrier Bag) Class 1. We can guarantee a 24 month shelf life (temperature $\leq 40^{\circ}\text{C}$ /relative humidity $\leq 90\%$). After the MBB has been opened, components may stay in areas with controlled temperature and humidity (temperature $\leq 30^{\circ}\text{C}$ /relative humidity $\leq 60\%$) for 168 hours [MSL 3]. For longer periods of time and/or higher temperature and/or higher relative humidity values, it is absolutely necessary to protect the components against humidity. If the reel inside the MBB is partially used, KEMET recommends to re-use the same MBB or to avoid areas without controlled temperature and humidity (see above). If the above conditions are not respected, components require a baking (minimum time: 48 hours at $55 \pm 5^{\circ}\text{C}$) before the reflow.

Manual assembly recommendations

If PCBs are assembled manually, care must be taken to avoid any mechanical damage to the components.

Our recommendations are the following (see Fig. 1):

- 1) When using tweezers, the components should be gripped across the two terminations (A)
- 2) Avoid any contact with the two cutting surfaces (C)
- 3) A vacuum pen is recommended on the top and bottom surfaces (B)

Flux/Cleaning/Storage and Moisture cont.

Manual soldering recommendations

LDE and LDB series have been designed for Surface Mount Technology, pick-and- place machines, and reflow soldering systems. Issues may occur using a manual soldering iron because the typical temperature for manual soldering is approximately 350°C. Therefore please pay careful attention:

- Never touch the capacitor body with the soldering iron but rather touch the soldering iron and the end termination with the tin wire edge (see Figure 2)
- If the soldering iron is equipped with a temperature controlling device, set the temperature to $250 \pm 3^{\circ}\text{C}$ and proceed as per Figure 2 (the maximum soldering time, on both terminations, is 5 seconds)
- A soldering iron that is NOT equipped with a temperature controlling device is not an ideal situation and operator experience is extremely important in this case. If you have a soldering iron that does not have a temperature controlling device, please use the following practical suggestions:
 - 1) Proceed as per Figure 2
 - 2) As soon as the tin wire starts melting, move the soldering iron away as quickly as possible
 - 3) Wait a few seconds and check that the soldering joint has been properly created
- If the soldering iron is equipped with a hot air flow device, set the hot air temperature to $250 \pm 3^{\circ}\text{C}$ and do not send the hot air directly onto the capacitor plastic body. In this situation, the operator's experience is very important.
- In any case, avoid mass-mounting SMD Film Capacitors manually.

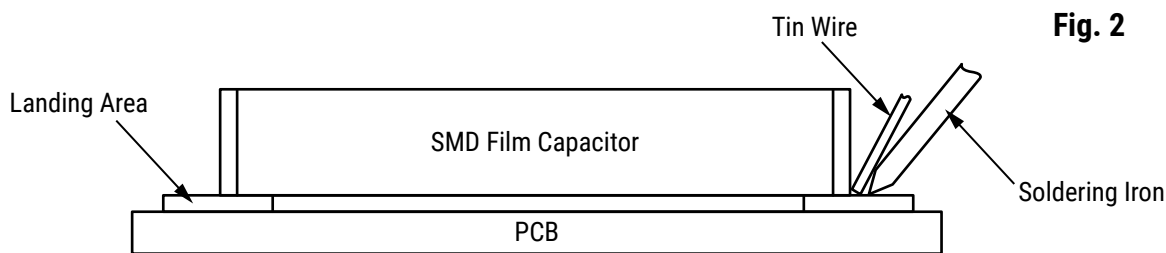

Packaging Quantities

Chip Size (EIA)	Height (mm)	Reel	Chip Size (EIA)	Height (mm)	Reel
1206	1.1	3,000	1210	1.9	2,250
1206	1.2	3,000	1210	2.0	2,250
1206	1.3	3,000	1210	2.3	2,250
1210	1.4	2,250	1812	1.7	4,000
1210	1.5	2,250	1812	2.0	3,000
1210	1.7	2,250			

Production Process Basic Suggestions

In case of:	Typical cause	Typical solution
No solder joint on one end termination	Landing area dimensions	See landing areas suggestions, page 9
	Solder paste quality	See solder paste suggestions, page 9
	Not-uniform solder paste thickness on the landing areas	Set the dispensing solder paste machine properly
	Wrong position of the capacitor on the landing areas	Set the pick and place machine properly
	Thermal profile temperature	See reflow recommendations, page 7
	Bad temperature distribution in the reflow oven	Check the reflow oven temperature distribution and variations"
No solder joint on both end termination	Landing area dimensions	See landing areas suggestions, page 9
	Solder paste quality	See solder paste suggestions, page 9
	No solder paste on the landing areas	Set the dispensing solder paste machine properly
	Thermal profile temperature	See reflow recommendations, page 7
	Bad temperature distribution in the reflow oven	Check the reflow oven temperature distribution and variations
	Oxidated end terminations	See moisture recommendations, page 8
Capacitor's body mechanical deformation	Too long time over 217°C	See reflow recommendations, page 7
	Too long time within T_{max} and $T_{max} - 5^{\circ}C$	See reflow recommendations, page 7
	Too high temperature ramp rate	See reflow recommendations, page 7
	Capacitor damaged by a soldering iron	See manual soldering recommendations, page 8
Capacitance drop (up to 20%)	Too long time over 217°C	See reflow recommendations, page 7
	Too long time within T_{max} and $T_{max} - 5^{\circ}C$	See reflow recommendations, page 7
	Too high temperature ramp rate	See reflow recommendations, page 7
	Capacitor damaged by a soldering iron	See manual soldering recommendations, page 8
Capacitance drop (over 20%)	Capacitor damaged by a soldering iron	See manual soldering recommendations, page 8

Note: Small fissures on the capacitor's cutting surface are actually slight detachments of two adjacent metallized film layers and have to be considered only as an aesthetic issue related to the SMD Film Capacitors' manufacturing process and technology.

Therefore, small fissures on SMD Film Capacitors are not comparable to cracks on SMD Ceramics.

Fissures do not influence SMD Film Capacitors' reliability in any way.

Carrier Taping & Packaging (IEC 60286-3)

Horizontal Taping Orientation

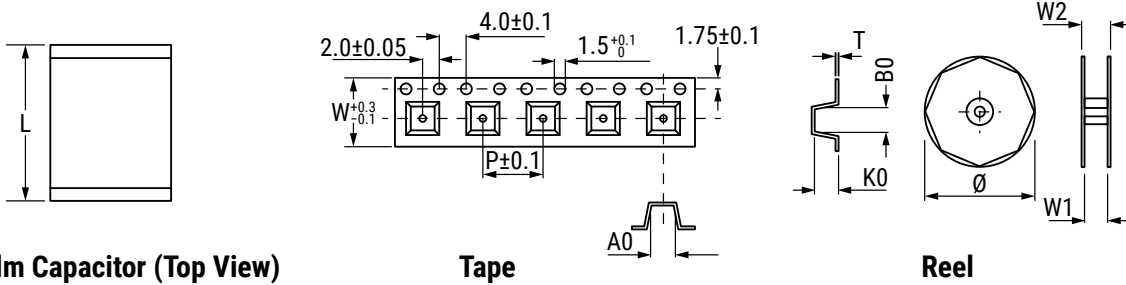

SMD Film Capacitor (Top View)

Tape

Reel

Chip Size (EIA) Horizontal Mounting	Dimensions in mm			Taping Specification							
	W	H	L	W	P ₁	A ₀	B ₀	K ₀	D	W ₁	W ₂
	Nominal	Nominal	Nominal	-0.1/+0.3	±0.1	Nominal	Nominal	Nominal	±2.0	-0/+2	Maximum
1206	1.7	All	3.3	8.0	4.0	2.0	3.8	1.3	180	8.0	12.0
1210	2.5	All	3.3	8.0	4.0	3.0	3.8	2.1	180	8.0	12.0
1812	3.3	≤ 1.9	4.7	12.0	8.0	3.8	5.3	2.0	330	12.0	16.0
1812	3.3	2.1 – 2.6	4.7	12.0	8.0	3.9	5.2	2.6	330	12.0	16.0

In accordance with IEC 60286-3

Materials:

- carrier tape: antistatic material
- cover tape: polyester + polythene
- reel: recyclable polystyrene

All parts in reels are packed in hermetically sealed Moisture Barrier Bag (MBB) Class 1.

KEMET Electronics Corporation Sales Offices

For a complete list of our global sales offices, please visit www.kemet.com/sales.

Disclaimer

YAGEO Corporation and its affiliates do not recommend the use of commercial or automotive grade products for high reliability applications or manned space flight.

All product specifications, statements, information and data (collectively, the "Information") in this datasheet are subject to change. The customer is responsible for checking and verifying the extent to which the Information contained in this publication is applicable to an order at the time the order is placed. All Information given herein is believed to be accurate and reliable, but it is presented without guarantee, warranty, or responsibility of any kind, expressed or implied.

Statements of suitability for certain applications are based on KEMET Electronics Corporation's ("KEMET") knowledge of typical operating conditions for such applications, but are not intended to constitute – and KEMET specifically disclaims – any warranty concerning suitability for a specific customer application or use. The Information is intended for use only by customers who have the requisite experience and capability to determine the correct products for their application. Any technical advice inferred from this Information or otherwise provided by KEMET with reference to the use of KEMET's products is given gratis, and KEMET assumes no obligation or liability for the advice given or results obtained.

Although KEMET designs and manufactures its products to the most stringent quality and safety standards, given the current state of the art, isolated component failures may still occur. Accordingly, customer applications which require a high degree of reliability or safety should employ suitable designs or other safeguards (such as installation of protective circuitry or redundancies) in order to ensure that the failure of an electrical component does not result in a risk of personal injury or property damage.

Although all product-related warnings, cautions and notes must be observed, the customer should not assume that all safety measures are indicated or that other measures may not be required.

Additional information about production site flexibility can be found [here](#)

KEMET is a registered trademark of KEMET Electronics Corporation.