

## 15A,30V High Efficiency Synchronous Step-Down DC/DC Converter

### Description

NDP13B01QB is a high efficiency, monolithic synchronous step-down DC/DC converter utilizing a Jitter frequency, average current mode control architecture. Capable of delivering up to 15A continuous load with excellent line and load regulation. The device operates from an input voltage range of 7V to 30V and provides an adjustable output voltage from 3.3V to 25V.

The NDP13B01QB features short circuit and thermal protection circuits to increase system reliability. The internal soft-start avoids input inrush current during startup.

The NDP13B01QB require a minimum number of external components, and a wide array of protection features to enhance reliability.

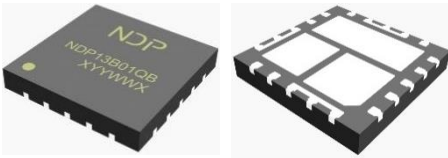

### Features

- VIN Range : 7V to 30V
- 15A Continuous Output Current
- Up to 93% Efficiency @ 24V Input
- Dual-Channel CC/CV Mode Control
- Brick Wall Current Limit
- Built in Adjustable Line-Compensation
- Adjustable Output Voltages
- Output Voltage Accuracy:  $\pm 1.5\%$
- Current Limit Accuracy:  $\pm 4mV$
- Integrated  $4.5m\Omega$  High Side Switch
- Integrated  $3.2m\Omega$  Low Side Switch
- Programable Frequency: 130kHz~300kHz
- Burst Mode Operation at Light Load
- Internal Loop Compensation
- Internal Soft Start
- Thermally Enhanced QFN5\*5 Package

### Applications

- Car Charger
- Rechargeable Portable Devices
- Networking Systems
- Distributed Power Systems

### Typical Application

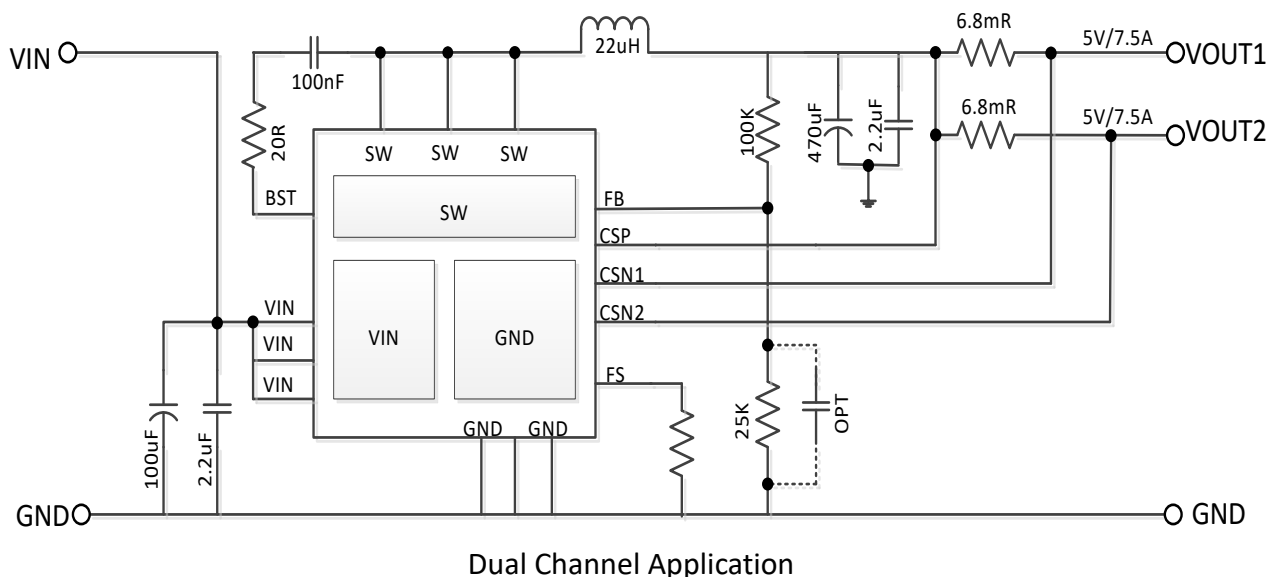



**Notes:**

- (1) **RoHS:** Quoted from **RoHS Detective (EU) 2015/863**, Deep-Pool defines "RoHS" to mean semiconductor products that are compliant with the current EU RoHS requirements. Where designed to be soldered at high temperatures, "RoHS" products are suitable for use in specified lead-free processes. Deep-Pool may reference these types of products as "**Pb-Free**".
- (2) **RoHS Exempt:** Deep-Pool defines "RoHS Exempt" to mean products that contain lead but are compliant with EU RoHS pursuant to a specific EU RoHS exemption.
- (3) **Green:** Deep-Pool defines "Green" to mean the content of Chlorine (Cl) and Bromine (Br) based flame retardants meet JEDEC (**JS709C**) low halogen requirements of  $\leq 1000$ ppm threshold.
- (4) **MSL, Peak Temp.** - The Moisture Sensitivity Level rating according to the JEDEC (**J-STD-020F**) industry standard classifications, as well as the peak solder temperature of SMT and the floor life after unpacking, which customers should pay attention and strictly comply with the standard to use.
- (5) There may be additional marking, which relates to the logo, the lot trace code information, or the environmental category on the device.

The information provided on this page represents **Deep-Pool's** knowledge and belief as of the date that it is provided. **Deep-Pool** bases its knowledge and belief on information provided by third parties and makes no representation or warranty as to the accuracy of such information. Efforts are underway to better integrate information from third parties. **Deep-Pool** has taken and continues to take reasonable steps to provide representative and accurate information but may not have conducted destructive testing or chemical analysis on incoming materials and chemicals. **Deep-Pool** and **Deep-Pool** suppliers consider certain information to be proprietary, and thus CAS numbers and other limited information may not be available for release.

**Pin Function and Definition**

Pin	Name	Description
1,2,3, PAD1	GND	Ground
4,5,9,11, 15	NC	No Connected
6,7,8, PAD2	VIN	Power Input
10	BST	Boot Strap
12,13,14, PAD3	SW	Switching, Connected With a Inductor
16	FB	Feedback of Output Voltage
17	CSP	Positive Pole of Current Sense
18	CSN1	Negative Pole1 of Current Sense
19	CSN2	Negative Pole2 of Current Sense
20	FS	Connect a Resistor to GND for Frequency Setting

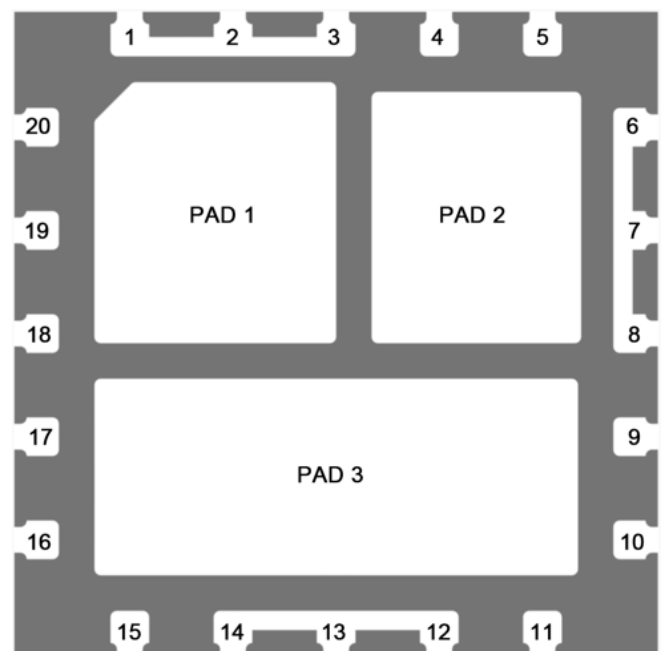

## Absolute Maximum Ratings (at TA = 25°C)

Characteristics	Symbol	Rating	Unit
VIN to GND		-0.3 to 30	V
SW to GND		-0.3 to VIN+0.3	V
BST to GND		-0.3 to VIN+7	V
FB, FS to GND		-0.3 to 6	V
CSP, CSN1, CSN2 to GND		-0.3 to 25	V
Operating Junction Temperature	TA	-40 to 150	°C
Storage Junction Temperature	Tstg	-65 to 150	°C

### Notes:

Stresses at or above those listed under Absolute Maximum Ratings may cause permanent damage to the product. This is a stress rating only; functional operation of the product at these or any other conditions above those indicated in the operational section of this specification is not implied. Operation beyond the maximum operating conditions for extended periods may affect product reliability.

## Recommended Operating Range

ELECTRICAL PARAMETER	MINIMUM	TYPICAL	MAXIMUM	UNIT
Input Voltage (VIN)	8		28	V
Output Voltage (VOUT)	3.6		20	V
Output Current (IOUT)			15	A
Maximum Duty Cycle (D <sub>MAX</sub> )			95	%
Thermal Resistance from Junction to case ( $\theta_{JC}$ )		15		°C/W
Thermal Resistance from Junction to ambient ( $\theta_{JA}$ )		40		°C/W

## Electrical Characteristics

T<sub>J</sub> = 25°C, V<sub>IN</sub> = 12V, unless otherwise noted.

Characteristics	Symbol	Conditions	Min	Typ	Max	Units
Input Voltage	V <sub>IN</sub>		7	-	30	V
UVLO OFF Voltage	V <sub>UVLO_OFF</sub>	V <sub>IN</sub> Rising		6.8	7	V
UVLO ON Voltage	V <sub>UVLO_ON</sub>	V <sub>IN</sub> Falling	6.2			V
Input Over Voltage Protect	V <sub>OVP</sub>			30		V
Quiescent Current	I <sub>CCQ</sub>	No Switch		1300		μA
Standby Current	I <sub>SB</sub>	No Load		1.7	2.2	mA
FB Reference Voltage	V <sub>REF</sub>		0.985	1	1.015	V
FB Bias Current	I <sub>FB</sub>				0.2	μA
Current Sense AMP	V <sub>CS1</sub>	CSP-CSN1	51	55	59	mV
	V <sub>CS2</sub>	CSP-CSN2	51	55	59	mV
Switching Frequency	F <sub>SW</sub>	FS Floating	110	130	150	kHz
		Connect 75kΩ Resister to GND	240	300	360	kHz
FS Shut Down Voltage	V <sub>FS_EN</sub>			0.6		V
Maximum Duty Cycle				98		%
Minimum On-Time				250		ns
Current Limit	I <sub>LIMIT</sub>		15			A
V <sub>OUT</sub> Short Protect	V <sub>SCP</sub>			3.0		V
Hiccup Interval	T <sub>HICCUP</sub>	FS Floating		400		ms
Soft Start Time	T <sub>SS</sub>			2		ms
R <sub>DSON</sub> of Power MOSFET	R <sub>DSON_H</sub>	Temperature=25°C		4.5		mΩ
	R <sub>DSON_L</sub>	Temperature=25°C		3.2		mΩ
Thermal Regulation Temperature	T <sub>TR</sub>			145		°C
Thermal shutdown Temperature	T <sub>SD</sub>			165		°C
Thermal Shutdown Hysteresis Temperature	T <sub>SH</sub>			30		°C

## Typical Performance Characteristics

T<sub>J</sub> = 25°C, V<sub>IN</sub> = 12V, unless otherwise noted.

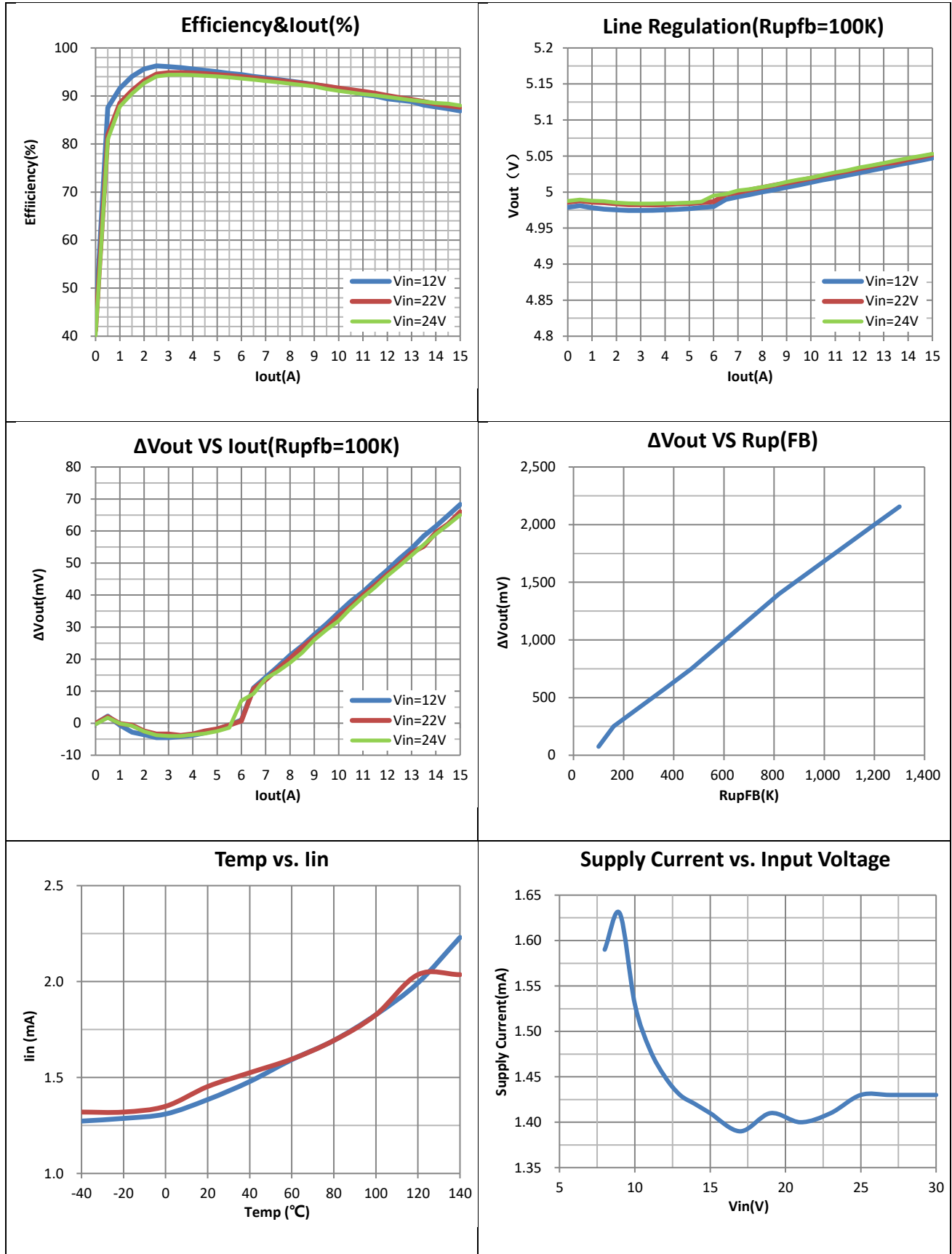

### Power On

Vin=12V, Vout=5.05V, Iout=15A  
(CH1=Vin, CH2=SW, CH3=Vout, CH4=Isw)

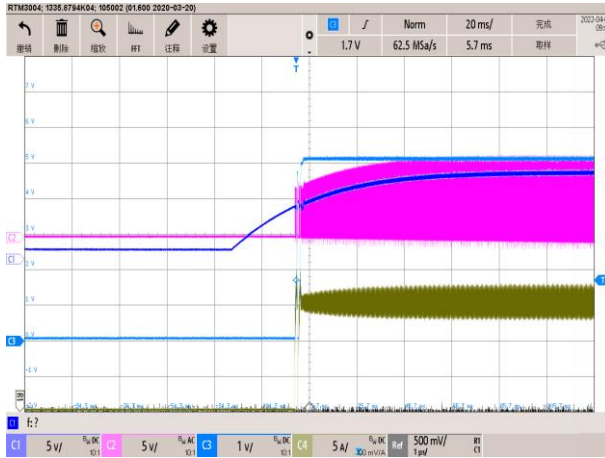

### Power Off

Vin=12V, Vout=5.05V, Iout=15A  
(CH1=Vin, CH2=SW, CH3=Vout, CH4=Isw)

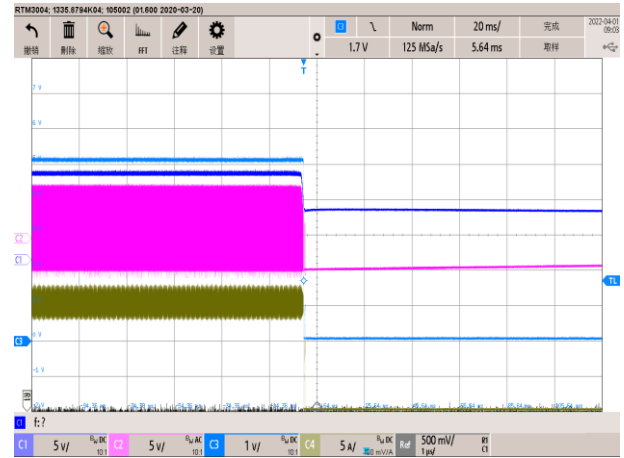

### Power On

Vin=24V, Vout=5.05V, Iout=15A  
(CH1=Vin, CH2=SW, CH3=Vout, CH4=Isw)

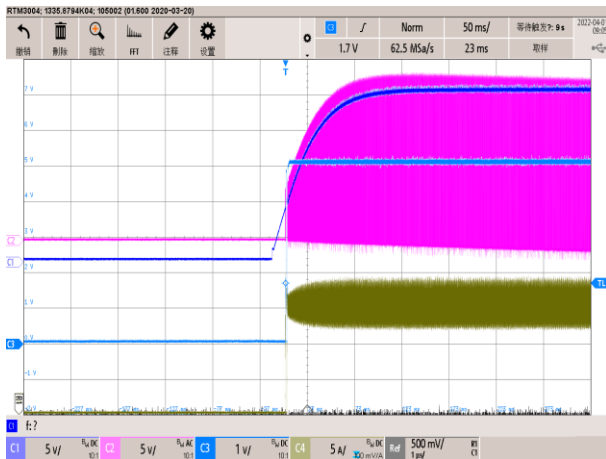

### Power Off

Vin=24V, Vout=5.05V, Iout=15A  
(CH1=Vin, CH2=SW, CH3=Vout, CH4=Isw)

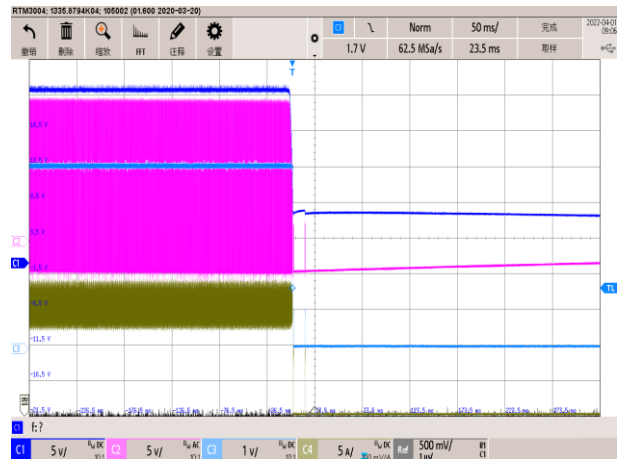

### Output Voltage Ripple

Vin=12V, Vout=5.05V, Iout=12A  
(CH1=Vin, CH2=SW, CH3=Vout, CH4=Isw)

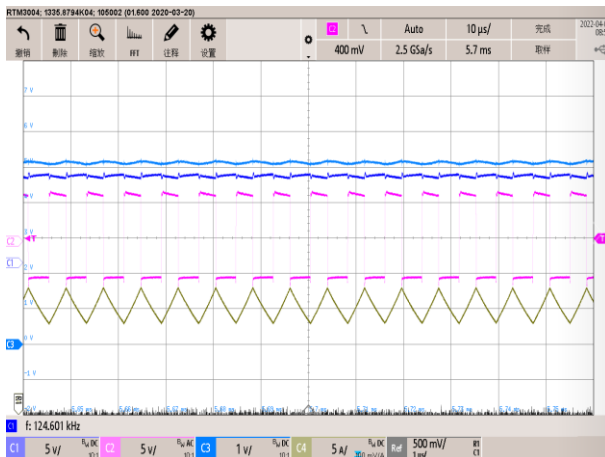

### Output Voltage Ripple

Vin=24V, Vout=5.05V, Iout=12A  
(CH1=Vin, CH2=SW, CH3=Vout, CH4=Isw)

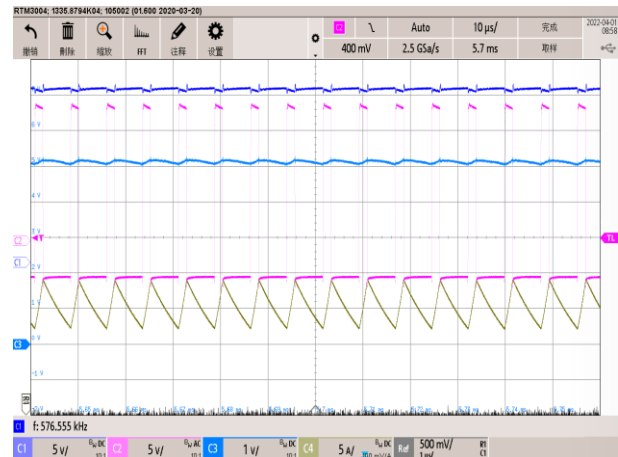

**Short Circuit**  
 Vin=12V, Freq=2.5Hz  
 (CH2=SW)

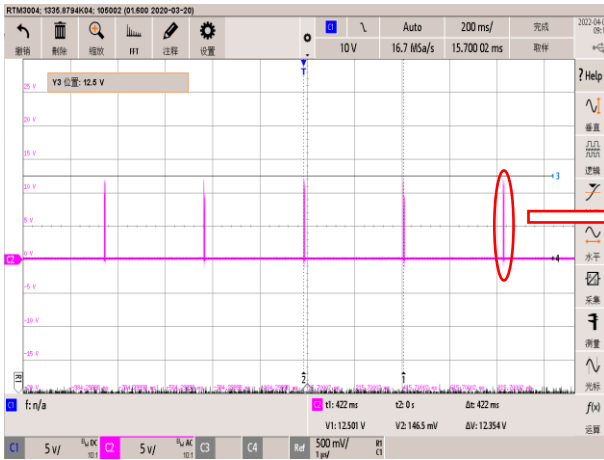

**Short Circuit**  
 Vin=12V, Freq=115kHz  
 (CH2=SW)

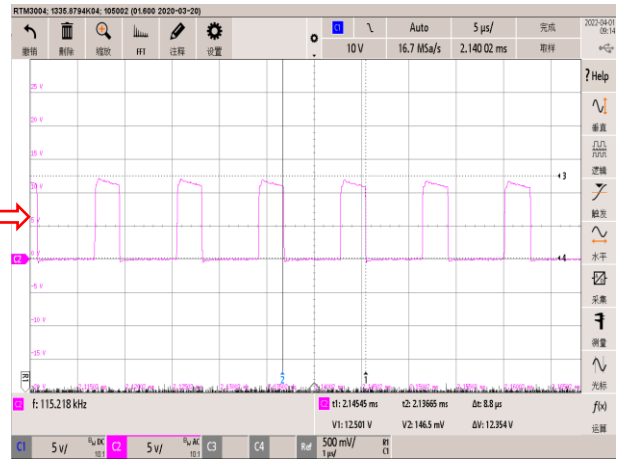

**Short Circuit**  
 Vin=24V, Freq=2.5Hz  
 (CH2=SW)

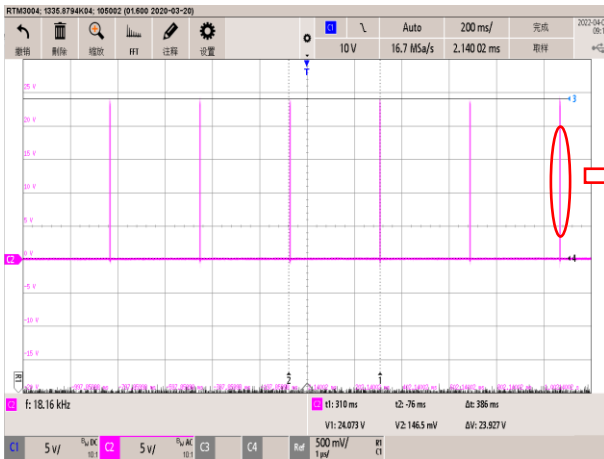

**Short Circuit**  
 Vin=24V, Freq=105kHz  
 (CH2=SW)

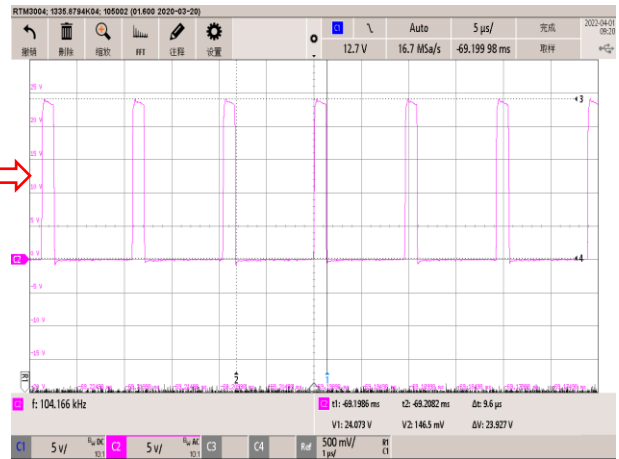



## Block Diagram

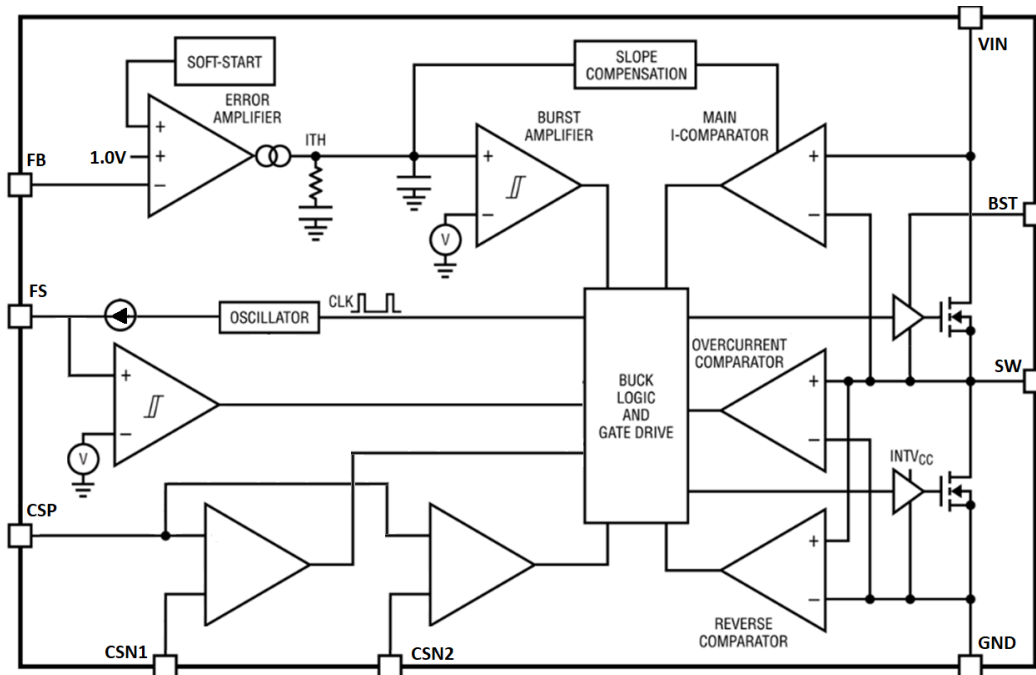

## Operational Description

The NDP13B01QB is a high efficiency, monolithic, synchronous step-down DC/DC converter utilizing a jitter frequency, average current mode control architecture. Average current mode control enables fast and precise control of the output current. It operates through a wide  $V_{IN}$  range and regulates with low quiescent current. An error amplifier compares the output voltage with an internal reference voltage of 1.0V and adjusts the peak inductor current accordingly. Overvoltage and undervoltage comparators will turn off the regulator.

### Main Control Loop

During normal operation, the internal top power switch (N-channel MOSFET) is turned on at the beginning of each clock cycle, causing the inductor current to increase. The sensed inductor current is then delivered to the average current amplifier, whose output is compared with a saw-tooth ramp. When the

voltage exceeds the  $V_{duty}$  voltage, the PWM comparator trips and turns off the top power MOSFET. After the top power MOSFET turns off, the synchronous power switch (N-channel MOSFET) turns on, causing the inductor current to decrease. The bottom switch stays on until the beginning of the next clock cycle, unless the reverse current limit is reached and the reverse current comparator trips. In closed-loop operation, the average current amplifier creates an average current loop that forces the average sensed current signal to be equal to the internal ITH voltage. Note that the DC gain and compensation of this average current loop is automatically adjusted to maintain an optimum current-loop response. The error amplifier adjusts the ITH voltage by comparing the divided-down output voltage ( $V_{FB}$ ) with a 1.0V reference voltage. If the load current changes, the error amplifier adjusts the average inductor current as needed to keep the output voltage in regulation.

## Low Current Operation

The discontinuous-conduction modes (DCMs) are available to control the operation of the NDP13B01QB at low currents. Burst Mode operation automatically switch from continuous operation to the Burst Mode operation when the load current is low.

## Cable Drop Compensation

Due to the resistive of charger's output Cable, The NDP13B01QB built in a simple user programmable cable voltage drop compensation using the impedance at the FB pin. Choose the proper resistance values for charger's output cable as show in Table 1:

$R_{FB\_TOP}$  is the upper resistor the resistors divider net.

$R_{FB\_LOW}$  is the lower resistor the resistors divider net.

$R_{FB\_TOP}$ (k $\Omega$ )	$R_{FB\_LOW}$ (k $\Omega$ )	Typ Cable Drop Compensation (mV)
100	25	150
160	39	250
360	91	570
470	120	750
820	200	1400
1200	300	2000

Table 1

## Frequency Selection and Shutdown

The switching frequency of the NDP13B01QB can be programmed through an external resistor between 130 kHz and 300 kHz, floating this pin set the switching frequency to 130 kHz, an external resistor can set the frequency up to 300 kHz. The switching frequency is set using the FS pins as shown in Table 2:

FS Resistor(K $\Omega$ )	Frequency (Hz)
Floating	130K
1000	150K
750	160K
510	170K
300	190K
200	210K
150	240K
75	300K

Table 2

When the FS pin is below 0.6V, the NDP13B01QB enters a low current shutdown state, reducing the DC supply current to 1.3mA.

## Constant Voltage Output

NDP13B01QB presets the VFB voltage to 1V. The Output can be set by extra resistance.

$$V_{OUT} = V_{FB} * \frac{R_{FB\_TOP} + R_{FB\_LOW}}{R_{FB\_LOW}}$$

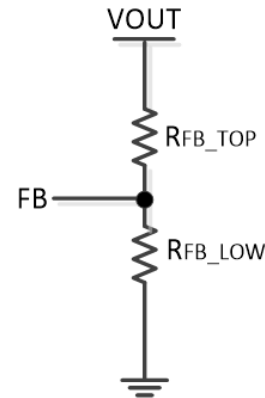

## Applications Information

### Input Capacitor ( $C_{IN}$ ) Selection

The input capacitance  $C_{IN}$  is needed to filter the square wave current at the drain of the top power MOSFET. To prevent large voltage transients from occurring, a low ESR input capacitor sized for the maximum RMS current should be used. The maximum RMS current is given by:

$$I_{RMS} \cong I_{OUT(MAX)} \frac{V_{OUT}}{V_{IN}} \sqrt{\frac{V_{IN}}{V_{OUT}} - 1}$$

This formula has a maximum at  $V_{IN} = 2V_{OUT}$ , where:  
 $I_{RMS} \cong I_{OUT}/2$ .

This simple worst-case condition is commonly used for design because even significant deviations do not offer much relief. Note that ripple current ratings from capacitor manufacturers are often based on only 2000 hours of life which makes it advisable to further derate the capacitor, or choose a capacitor rated at a higher temperature than required. Several capacitors may also be paralleled to meet size or height requirements in the design. For low input voltage applications, sufficient bulk input capacitance is

needed to minimize transient effects during output load changes.

### Output Capacitor ( $C_{OUT}$ ) Selection

The selection of  $C_{OUT}$  is determined by the effective series resistance (ESR) that is required to minimize voltage ripple and load step transients as well as the amount of bulk capacitance that is necessary to ensure that the control loop is stable. Loop stability can be checked by viewing the load transient response. The output ripple,  $\Delta V_{OUT}$ , is determined by:

$$\Delta V_{OUT} < \Delta I_L \left( \frac{1}{8 \cdot f \cdot C_{OUT}} + ESR \right)$$

The output ripple is highest at maximum input voltage since  $\Delta I_L$  increases with input voltage. Multiple capacitors placed in parallel may be needed to meet the ESR and RMS current handling requirements. Dry tantalum, special polymer, aluminum electrolytic, and ceramic capacitors are all available in surface mount packages. Special polymer capacitors are very low ESR but have lower capacitance density than other types. Tantalum capacitors have the highest capacitance density, but it is important to only use types that have been surge tested for use in switching power supplies. Aluminum electrolytic capacitors have significantly higher ESR, but can be used in cost-sensitive applications provided that consideration is given to ripple current ratings and long-term reliability. Ceramic capacitors have excellent low ESR characteristics and small footprints.

### Inductor Selection

Given the desired input and output voltages, the inductor value and operating frequency determine the ripple current:

$$\Delta I_L = \frac{V_{OUT}}{F * L} \left( 1 - \frac{V_{OUT}}{V_{IN(MAX)}} \right)$$

Lower ripple current reduces power losses in the inductor, ESR losses in the output capacitors and output voltage ripple. Highest efficiency operation is

obtained at low frequency with small ripple current. However, achieving this requires a large inductor. There is a trade-off between component size, efficiency, and operating frequency. A reasonable starting point is to choose a ripple current that is about 40% of  $I_{OUT(MAX)}$ . To guarantee that ripple current does not exceed a specified maximum, the inductance should be chosen according to:

$$L = \frac{V_{OUT}}{F * \Delta I_{L(MAX)}} \left( 1 - \frac{V_{OUT}}{V_{IN(MAX)}} \right)$$

Once the value for L is known, the type of inductor must be selected. Actual core loss is independent of core size for a fixed inductor value, but is very dependent on the inductance selected. As the inductance or frequency increases, core losses decrease. Unfortunately, increased inductance requires more turns of wire and therefore copper losses will increase. Copper losses also increase as frequency increases. Ferrite designs have very low core losses and are preferred at high switching frequencies, so design goals can concentrate on copper loss and preventing saturation. Ferrite core material saturates “hard”, which means that inductance collapses abruptly when the peak design current is exceeded. This results in an abrupt increase in inductor ripple current and consequent output voltage ripple. Do not allow the core to saturate!

Different core materials and shapes will change the size/current and price/current relationship of an inductor. Toroid or shielded pot cores in ferrite or permalloy materials are small and don't radiate much energy, but generally cost more than powdered iron core inductors with similar characteristics. The choice of which style inductor to use mainly depends on the price versus size requirements and any radiated field/EMI requirements. New designs for surface mount inductors are available from Coilcraft, Toko, Vishay, NEC/Tokin, TDK and Würth Elektronik.

## Efficiency Considerations

The percent efficiency of a switching regulator is equal to the output power divided by the input power times 100%. It is often useful to analyze individual losses to determine what is limiting the efficiency and which change would produce the most improvement. Percent efficiency can be expressed as: % Efficiency =  $100\% - (\text{Loss1} + \text{Loss2} + \dots)$  where Loss1, Loss2, etc. are the individual losses as a percentage of input power. Although all dissipative elements in the circuit produce losses, three main sources usually account for most of the losses in NDP13B01QB circuits: 1) I<sup>2</sup>R losses, 2) switching and biasing losses, 3) other losses.

## Thermal Conditions

In most applications, the NDP13B01QB does not dissipate much heat due to its high efficiency and low thermal resistance. However, in applications where the NDP13B01QB is running at high ambient temperature, high VIN, and maximum output current

load, the heat dissipated may exceed the maximum junction temperature of the part.

If the junction temperature reaches approximately 165°C, both power switches will be turned off until the temperature drops about 30°C cooler. To avoid the NDP13B01QB from exceeding the maximum junction temperature, the user will need to do some thermal analysis. The goal of the thermal analysis is to determine whether the power dissipated exceeds the maximum junction temperature of the part. If the application calls for a higher ambient temperature and/or higher switching frequency, care should be taken to reduce the temperature rise of the part by using a heat sink or forced air flow.

## EMI/EMC

To solve EMI electromagnetic interference, SW pin should add a circuit of RC filter, a 20Ω resistor and a 1nF capacitor, BST pin reserved 20Ω string 100nF. If the application version enough volume, can be reserved at input end type II circuit.

Package Outline Drawing

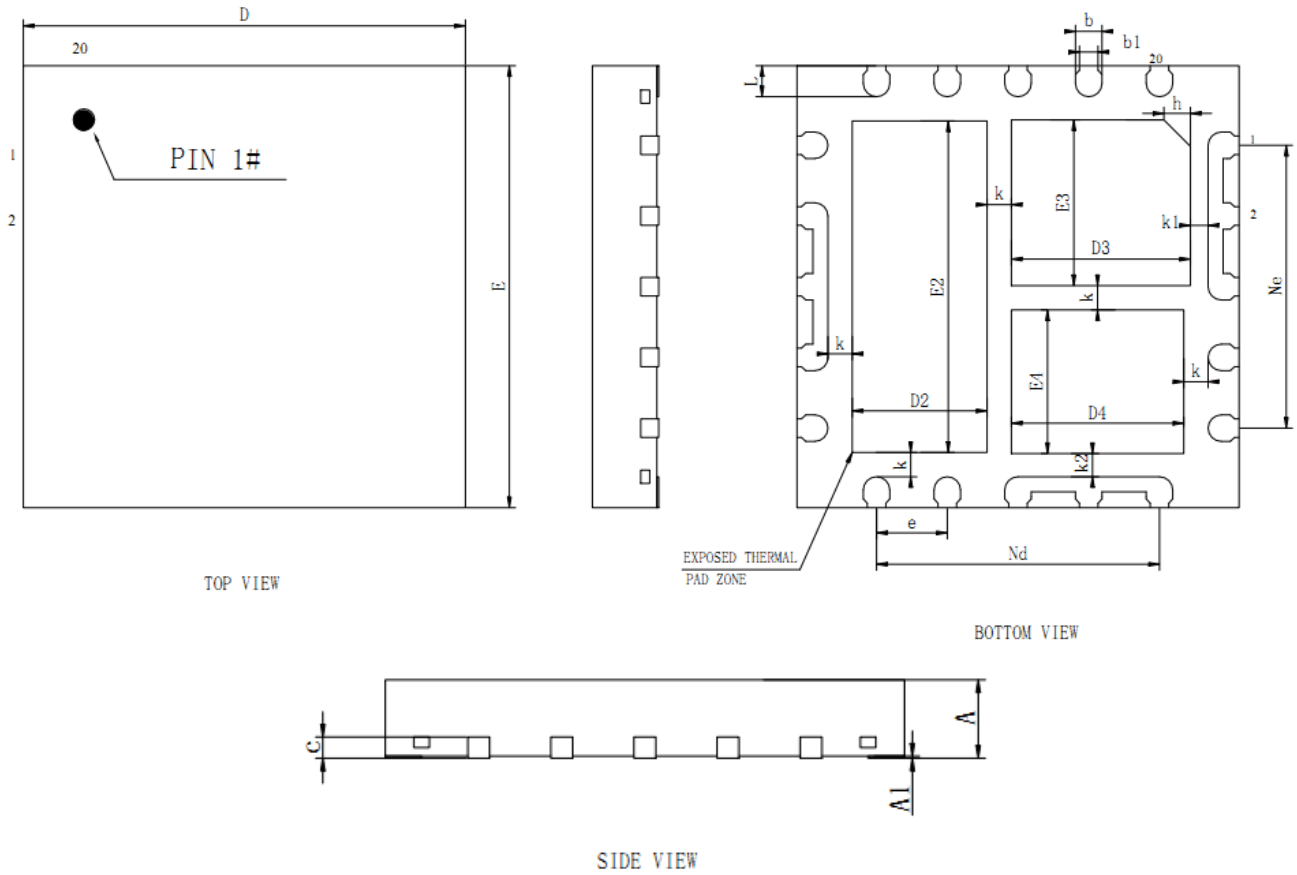

Dimensional References				Unit: mm			
SYMBOL	MIN	NOR	MAX	SYMBOL	MIN	NOR	MAX
A	0.7	0.75	0.8	Ne	3.20 REF		
A1	0.00	0.02	0.05	E	4.90	5.00	5.10
b	0.25	0.30	0.35	E2	3.65	3.75	3.85
b1	0.21REF			E3	1.775	1.875	1.975
c	0.203 REF			E4	1.525	1.625	1.725
D	4.90	5.00	5.10	L	0.30	0.35	0.40
D2	1.425	1.525	1.625	h	0.25	0.30	0.35
D3	1.925	2.025	2.125	K	0.275 REF		
D4	1.85	1.95	2.05	K1	0.20 REF		
e	0.80 REF			K2	0.2625 REF		
Nd	3.20 REF						

Notes

1. Use millimeters as the primary measurement
2. Dimensioning and tolerances conform to ASME Y14.5M. – 1994
3. These dimensions do not include mold flash or protrusions.
4. Mold flash or protrusions shall not exceed 0.15mm

## Disclaimer

ALL PRODUCT, PRODUCT SPECIFICATIONS AND DATA ARE SUBJECT TO CHANGE WITHOUT NOTICE TO IMPROVE RELIABILITY, FUNCTION OR DESIGN OR OTHERWISE.

**Jiangsu Deep-Pool Microelectronics Co., Ltd**, and its affiliates, agents, employees, as well as all persons acting on its or their behalf (collectively, “**Deep-Pool**”), disclaim any and all liability for any errors, inaccuracies or incompleteness contained in any datasheet or in any other disclosure relating to any product.

**Deep-Pool** makes no warranty, representation or guarantee regarding the suitability of the products for any particular purpose or the continuing production of any product. To the maximum extent permitted by applicable law, Deep-Pool disclaims (a) any and all liability arising out of the application or use of any product, (b) any and all liability, including without limitation special, consequential or incidental damages, and (c) any and all implied warranties, including warranties of fitness for particular purpose, non-infringement and merchantability.

Statements regarding on the suitability of products for certain types of applications are based on Deep-Pool's knowledge of typical requirements that are often placed on Deep-Pool products in generic applications. Such statements are not binding statements about the suitability of products for a particular application. It is the customer's responsibility to validate that a particular product with the properties described in the product specification is suitable for use in a particular application. Parameters provided in datasheets or specifications may vary in different applications and performance may vary over time. All operating parameters, including typical parameters, must be validated for each customer application by the customer's technical experts. Product specifications should not be expanded or otherwise modify Deep-Pool's terms and conditions of purchase, including but not limited to the warranty announced therein.

Unless expressly stated in writing, Deep-Pool products are not designed for use in medical, life-saving, or life-sustaining applications or for any other application in which the failure of product could result in personal injury or death. Customers who use or sell Deep-Pool products not expressly indicated for use in such applications do so at their own risk. Please contact authorized Deep-Pool personnel to obtain written terms and conditions regarding products designed for such applications.