

THIS DRAWING IS UNPUBLISHED. RELEASED FOR PUBLICATION 20  
 © COPYRIGHT 20 BY - ALL RIGHTS RESERVED.

REVISIONS				
P	LTR	DESCRIPTION	DATE	APVD
D2		REVISED PER ECR-16-011494	20JUN2017	NK CX
D3		ECO-19-006934	13MAY2019	AP WS
D4		REVISED PER ECN-22-158558	20JUN2022	WLS VS
D5		REVISED PER ECN-23-242776	14DEC2023	WLS VS

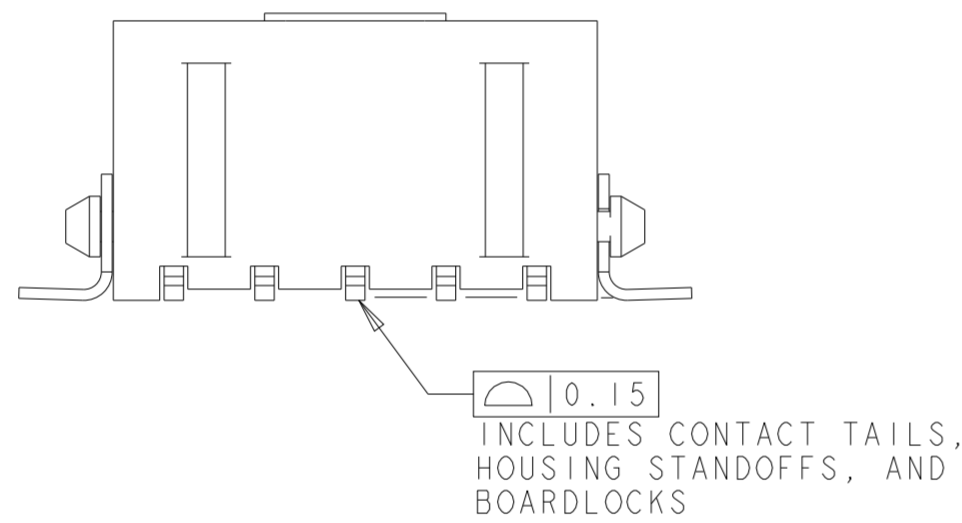
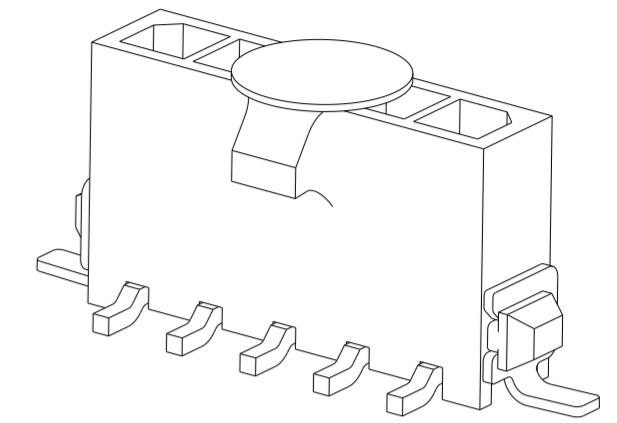
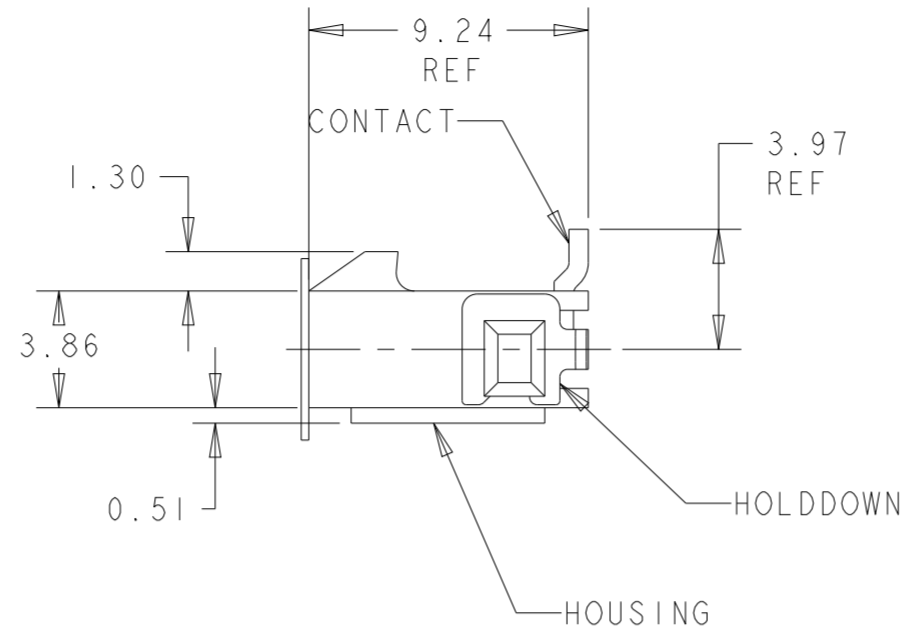
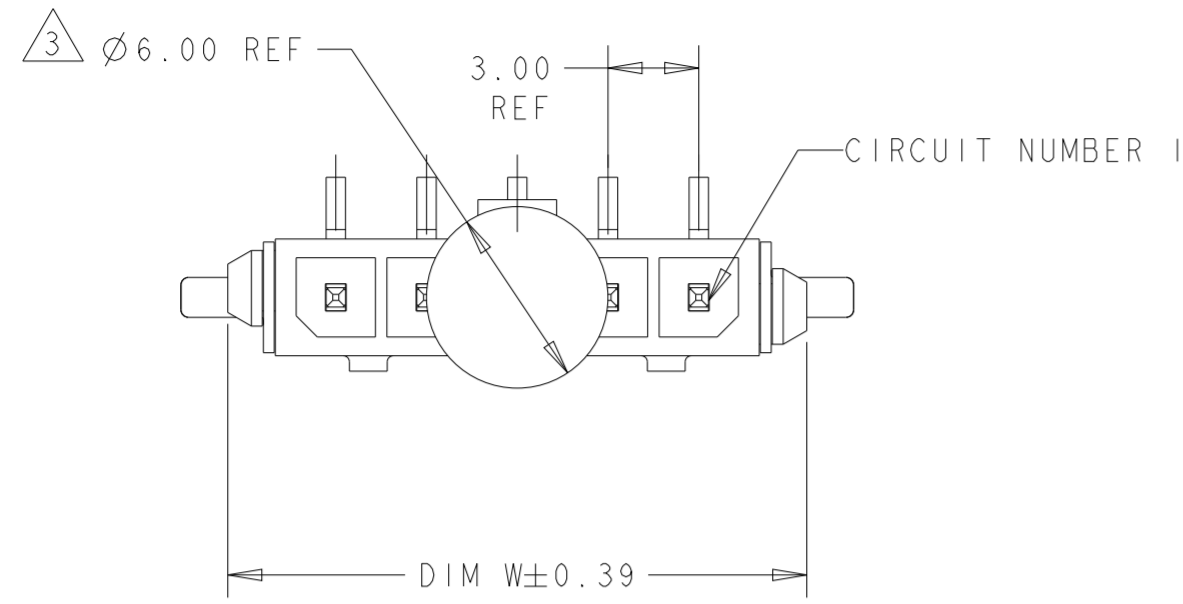

- 1 MATERIAL: HOUSING - UL 94V-0 RATED HIGH TEMP NYLON, COLOR BLACK.  
CONTACTS - BRASS  
HOLDDOWNS - PHOSPHOR BRONZE.
- 2 RECOMMENDED PC BOARD THICKNESS OF 1.57.
- 3 KAPTON VACUUM PICK UP BUTTON.
- 4 PLATING: CONTACTS - 0.38µm MINIMUM GOLD ON MATING AREA,  
2.54µm MINIMUM MATTE TIN ON SOLDER TAILS,  
ALL OVER 1.27µm MINIMUM NICKEL.  
HOLDDOWNS - 2.54µm MINIMUM MATTE TIN OVER 1.27µm MINIMUM NICKEL.
- 5 COUNTERPART RECOMMENDED IS PN 1445022 OR 2008571 (DASH ACC. TO NUMBER OF POSITION).
- 6 FOR REELING DIRECTION AND PACKAGING TYPE, SEE SPECIFICATION 114-13000.

OBSOLETE

33.00	40.41	40.00	12	3-1445087-2
30.00	37.41	37.00	11	3-1445087-1
27.00	34.41	34.00	10	3-1445087-0
24.00	31.41	31.00	9	2-1445087-9
21.00	28.41	28.00	8	2-1445087-8
18.00	25.41	25.00	7	2-1445087-7
15.00	22.41	22.00	6	2-1445087-6
12.00	19.41	19.00	5	2-1445087-5
9.00	16.41	16.00	4	2-1445087-4
6.00	13.41	13.00	3	2-1445087-3
3.00	10.41	10.00	2	2-1445087-2
DIM Z	DIM V	DIM W	NO. OF POSN	PART NUMBER

THIS DRAWING IS A CONTROLLED DOCUMENT.		DWN J. ROOT 09OCT2000	TE Connectivity	
DIMENSIONS: mm		CHK K. WHITAKER 20-FEB-2001		
TOLERANCES UNLESS OTHERWISE SPECIFIED:		APVD C. JONES 20-FEB-2001	NAME VERTICAL SURFACE MOUNT HEADER ASSY, 15 MIC GOLD CONTACTS, SURFACE MOUNT, HOLDDOWNS, SGL ROW, MICRO MATE-N-LOK™	
0 PLC ± 1 PLC ± 2 PLC ±0.20 3 PLC ± 4 PLC ± ANGLES ±° FINISH		PRODUCT SPEC 108-1836	SIZE A2	CAGE CODE 00779
MATERIAL 1		APPLICATION SPEC 114-13000	DRAWING NO C-1445087	RESTRICTED TO -
		WEIGHT -	SCALE 4:1	SHEET 1 OF 2
		CUSTOMER DRAWING	REV D5	

THIS DRAWING IS UNPUBLISHED. RELEASED FOR PUBLICATION 20  
 © COPYRIGHT 20 BY - ALL RIGHTS RESERVED.

REVISIONS				
P	LTR	DESCRIPTION	DATE	APVD
-	-	SEE SHEET 1	-	-

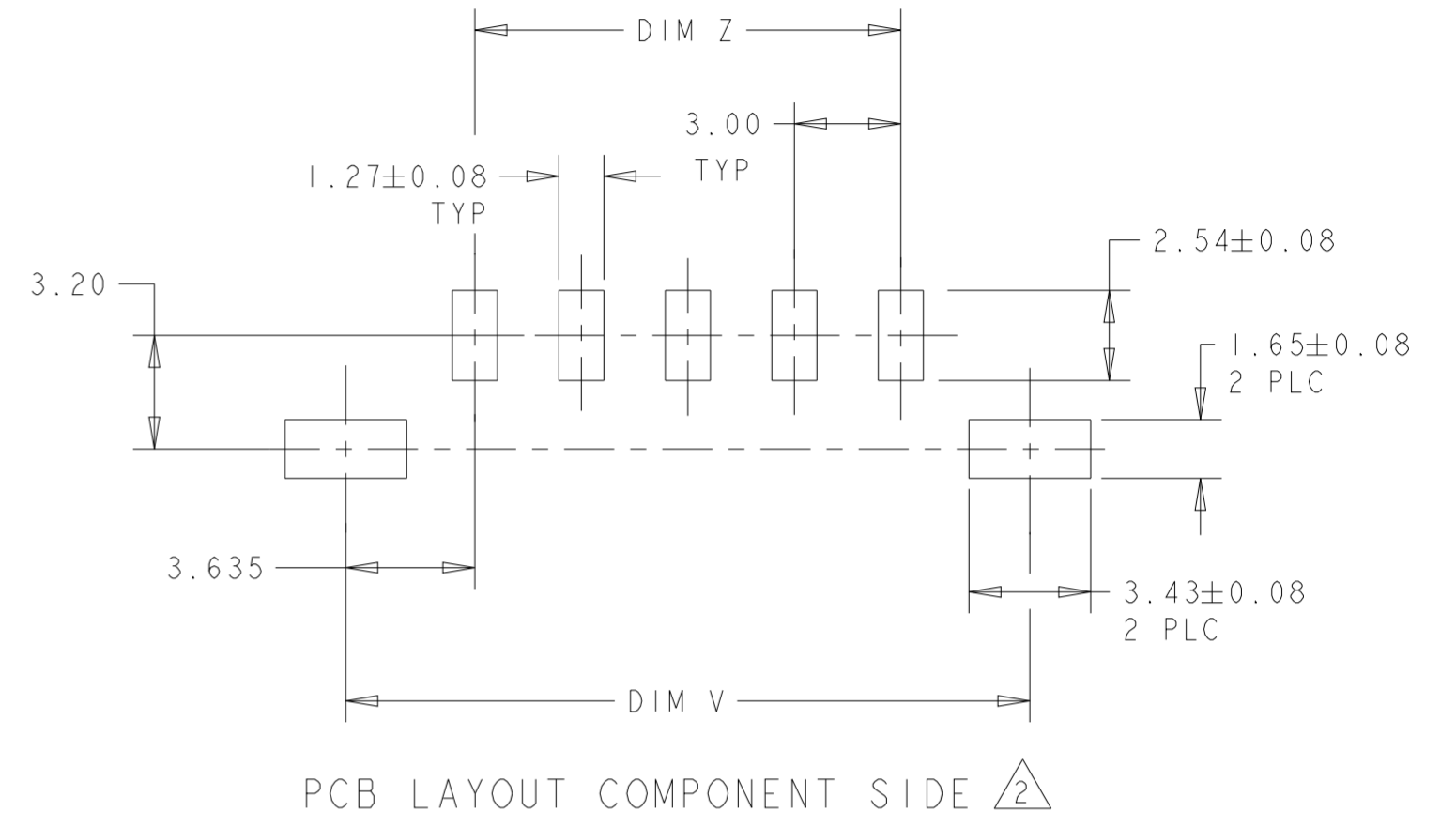
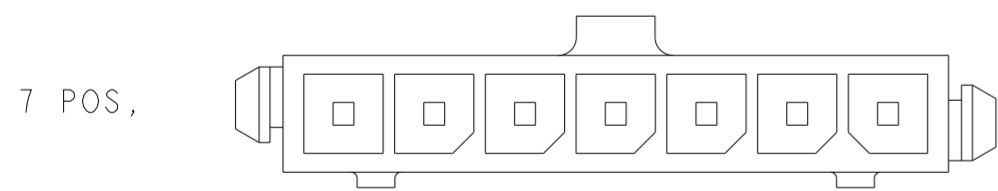
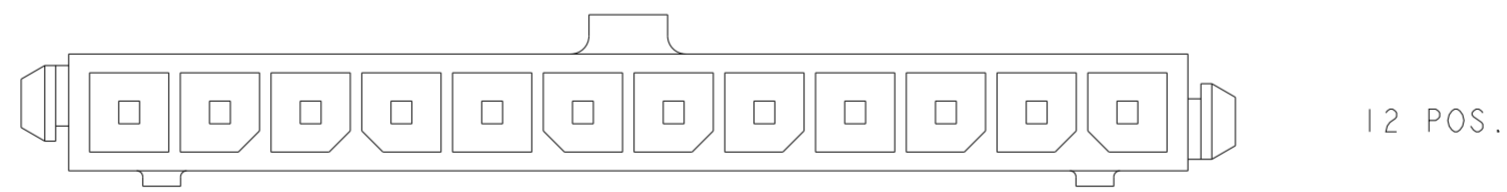
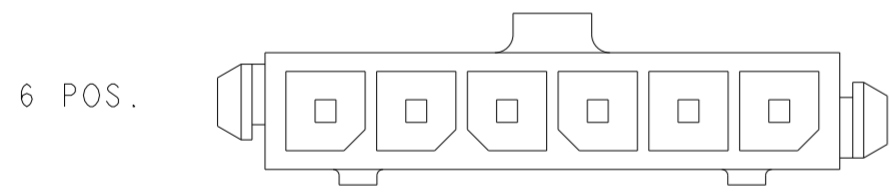
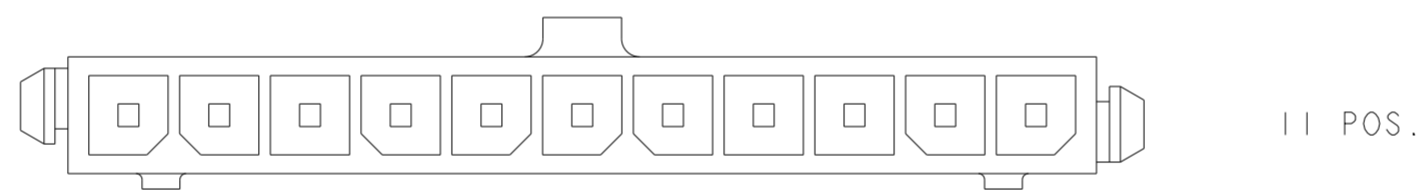
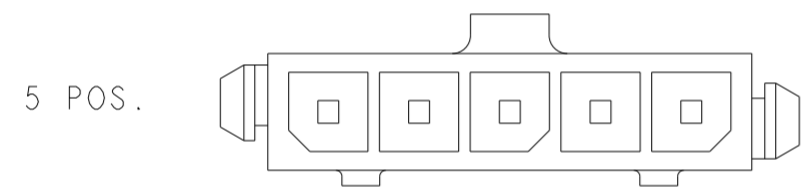
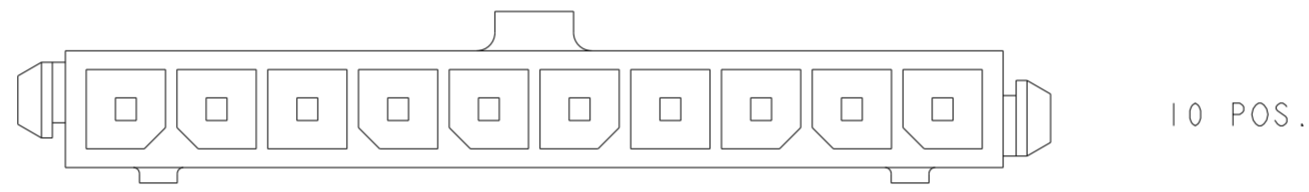
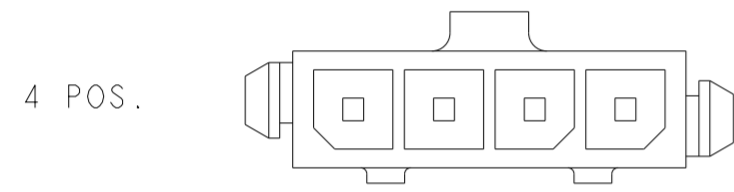
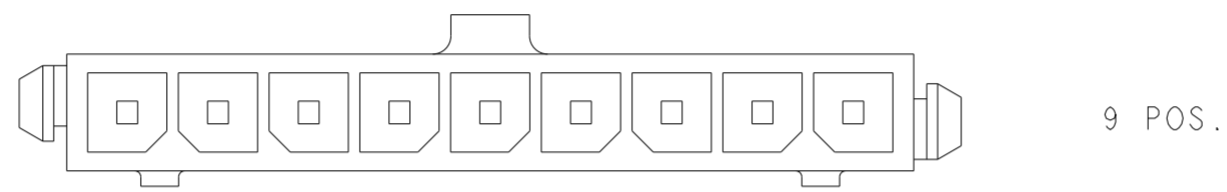
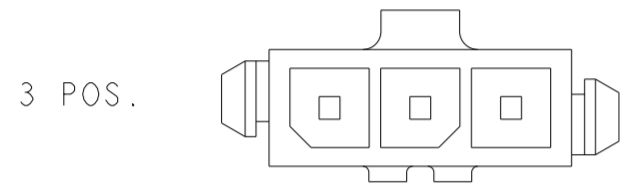
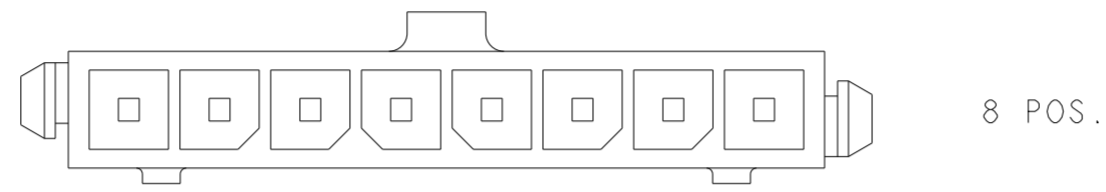
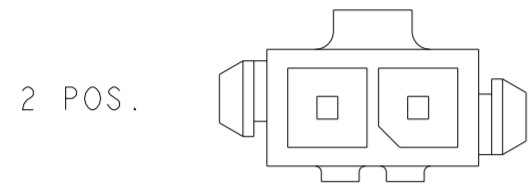

KEYING BY POSITION SIZE

THIS DRAWING IS A CONTROLLED DOCUMENT.		DWN J. ROOT 09OCT2000	TE Connectivity	
DIMENSIONS: mm		CHK K. WHITAKER 20-FEB-2001		
TOLERANCES UNLESS OTHERWISE SPECIFIED:		APVD C. JONES 20-FEB-2001	NAME VERTICAL SURFACE MOUNT HEADER ASSY, 15 MIC GOLD CONTACTS, SURFACE MOUNT HOLDDOWNS, SGL ROW, MICRO MATE-N-LOK	
		PRODUCT SPEC 108-1836	SIZE A2	CAGE CODE 00779
MATERIAL		APPLICATION SPEC 114-13000	DRAWING NO C-1445087	RESTRICTED TO
FINISH		WEIGHT	SCALE 4:1	SHEET 2 OF 2
-		CUSTOMER DRAWING	REV D5	