



Precision Voltage Regulator Controller

ADP3310

FEATURES

- ±1.5% Accuracy Over Line, Load and Temperature
- Low 800 μ A (Typical) Quiescent Current
- Shutdown Current: 1 μ A (Typical)
- Stable with 10 μ F Load Capacitor
- +2.5 V to +15 V Operating Range
- Fixed Output Voltage Options: 2.8 V, 3 V, 3.3 V, 5 V
- Up to 10 A Output Current
- SO-8 Package
- 40°C to +85°C Ambient Temperature Range
- Internal Gate to Source Protective Clamp
- Current and Thermal Limiting
- Programmable Current Limit
- Foldback Current Limit

APPLICATIONS

- Desktop Computers
- Handheld Instruments
- Cellular Telephones
- Battery Operated Devices
- Solar Powered Instruments
- High Efficiency Linear Power Supplies
- Battery Chargers

SOL

FUNCTIONAL BLOCK DIAGRAM

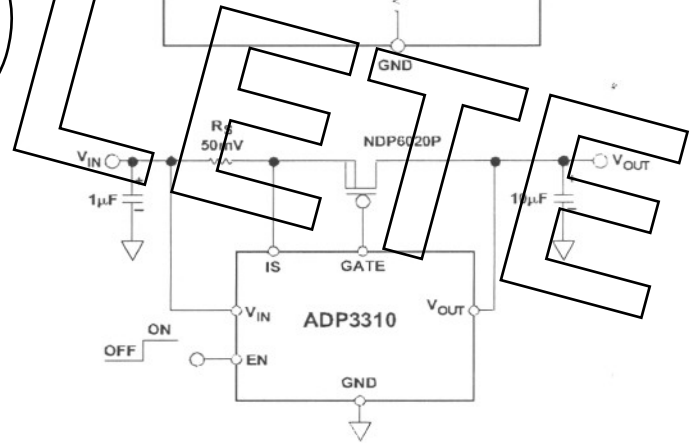
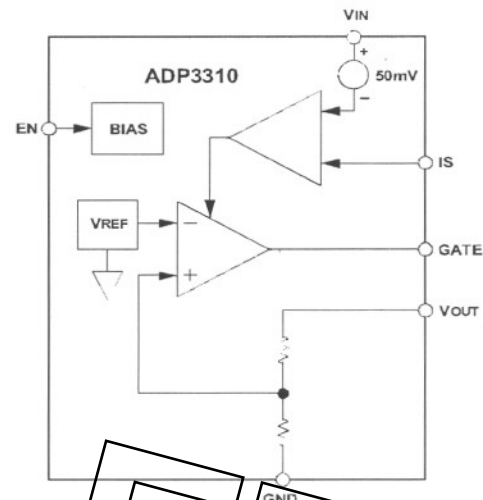

Figure 1. Typical Application Circuit

GENERAL DESCRIPTION

The ADP3310 is a precision voltage regulator controller that can be used with an external Power PMOS device such as the NDP6020P to form a two chip low dropout linear regulator. The low quiescent current (800 μ A) and the Enable feature make this device especially suitable for battery powered systems. The dropout voltage at 1 A is only 70 mV when used with the NDP6020P, allowing operation with minimal headroom and prolonging battery useful life. The ADP3310 can drive a wide range of currents, depending on the external PMOS device used.

Additional features of this device include: high accuracy ($\pm 1.5\%$) over line, load and temperature, gate-to-source voltage clamp to protect the external MOSFET and foldback current limit. A current limit threshold voltage of 50 mV (typ) allows 50 m Ω of board metal trace resistance to provide a 1 A current limit.

The ADP3310 operates from a wide input voltage range from 2.5 V to 15 V and is available in a small SO-8 package.

REV. A

Information furnished by Analog Devices is believed to be accurate and reliable. However, no responsibility is assumed by Analog Devices for its use, nor for any infringements of patents or other rights of third parties which may result from its use. No license is granted by implication or otherwise under any patent or patent rights of Analog Devices.

ADP3310—SPECIFICATIONS ($V_{IN} = V_{OUT} + 1\text{ V}$, $T_A = -40^\circ\text{C}$ to $+85^\circ\text{C}$ unless otherwise noted)

Parameter	Conditions	Symbol	Min	Typ	Max	Units
OUTPUT VOLTAGE ACCURACY (Figure 1)	$V_{IN} = V_{OUT} + 1\text{ V}$ to 15 V $V_{EN} = 2\text{ V}$, $I_{OUT} = 10\text{ mA}$ to 1 A	V_{OUT}	-1.5		+1.5	%
QUIESCENT CURRENT						
Shutdown Mode	$V_{IN} = 0\text{ V}$	I_{GND}		1	10	μA
Normal Mode	$V_{IN} = 2\text{ V}$, $I_{OUT} = 500\text{ }\mu\text{A}$	I_{GND}		800	1000	μA
GATE TO SOURCE CLAMP VOLTAGE	$V_{OUT} = 0\text{ V}$, $V_{IN} = 15\text{ V}$			8	10	V
GATE DRIVE MINIMUM VOLTAGE				0.7		V
GATE DRIVE CURRENT (SINK/SOURCE)			1			mA
GAIN $\left(\frac{\Delta V_{GS}}{\Delta V_{OUT}}\right)$				80		dB
CURRENT LIMIT THRESHOLD VOLTAGE	$V_{IN} - V_{IS}$		40	50	80	mV
LOAD REGULATION	$I_{OUT} = 10\text{ mA}$ to 1 A		-10		10	mV
LINE REGULATION	$V_{IN} = V_{OUT} + 1\text{ V}$ to 15 V $I_{OUT} = 100\text{ mA}$		-10		10	mV
SHUTDOWN INPUT VOLTAGE	V_{IH} V_{IL}	V_{EN}	2.0		0.4	V V
SHUTDOWN INPUT CURRENT	$V_{EN} = 0\text{ V}$ to 5.0 V	I_{EN}	-10		+10	μA

Specifications subject to change without notice.

ABSOLUTE MAXIMUM RATINGS*

Input Voltage, V_{IN}	+20 V
Enable Input Voltage	0.3 V to $V_{IN} + 0.3\text{ V}$
Operating Junction Temperature Range	-40°C to +125°C
Operating Temperature Range	-40°C to +85°C
Storage Temperature Range	-65°C to +150°C
Lead Temperature (Soldering, 10 sec)	+300°C
Vapor Phase (60 sec)	+215°C
Infrared (15 sec)	+220°C
θ_{JA} (4-Layer Board)	+121°C/W
θ_{JA} (2-Layer Board)	+150°C/W

*This is a stress rating only; operation beyond these limits can cause the device to be permanently damaged.

CAUTION

ESD (electrostatic discharge) sensitive device. Electrostatic charges as high as 4000 V readily accumulate on the human body and test equipment and can discharge without detection. Although the ADP3310 features proprietary ESD protection circuitry, permanent damage may occur on devices subjected to high energy electrostatic discharges. Therefore, proper ESD precautions are recommended to avoid performance degradation or loss of functionality.



ADP3310

ORDERING GUIDE

Model	Output Voltage	Package Option*
ADP3310AR-2.8	2.8 V	SO-8
ADP3310AR-3	3 V	SO-8
ADP3310AR-3.3	3.3 V	SO-8
ADP3310AR-5	5 V	SO-8

*SO = Small Outline. Contact the factory for the availability of other output voltage options from 5 V to 16.5 V.
 Refer to the ADP3319 data sheet for 1.8 V and 2.5 V output voltage options.
 Refer to the ADP3328 data sheet for adjustable output version.

**PIN CONFIGURATION
SO-8**

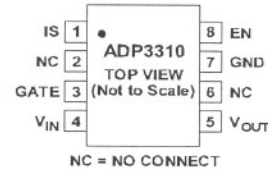

PIN FUNCTION DESCRIPTIONS

Pin SO-8	Name	Function
1	IS	Current Sense. Connected to the more negative terminal of the sense resistor as well as the Power MOSFET's source pin. IS must be tied to VIN pin if the current limit feature is not used.
2, 6	NC	No Connect.
3	GATE	Gate Drive for the external MOSFET.
4	VIN	Input Voltage. This is also the positive terminal connection of the current sense resistor.
5	VOUT	Output Voltage Sense. This pin is connected to the MOSFET's drain and directly to the load for optimal load regulation. Bypass to ground with a 10 μF or larger capacitor.
7	GND	Device Ground. This pin should be tied to system ground closest to the load.
8	EN	Enable. Pulling this pin to a logic High or tying the pin to the input voltage will enable the output. Pulling this pin low will disable the regulator output.

OBSOLETE

Table I. Alternate PMOS Devices

PMOS	NDP6020P	IRF7404	Si9434DY
Manufacturer	Fairchild	IR	Temic
R _{DS(ON)}	0.075 Ω @ V _{GS} = -2.5 V	0.06 Ω @ V _{GS} = -2.7 V	0.06 Ω @ V _{GS} = -2.5 V
I _D Continuous @ 25°C	-27 A @ V _{GS} = -4.5 V	-5.3 A @ V _{GS} = -4.5 V	-6.4 A
P _D @ 25°C	75 W	1.6 W	2.5 W
Derating Factor	0.5 W/°C	0.011 W/°C	1.6 W @ 70°C
Package	TO-220	SO-8	SO-8

ADP3310—Typical Performance Characteristics (Circuit of Figure 1)

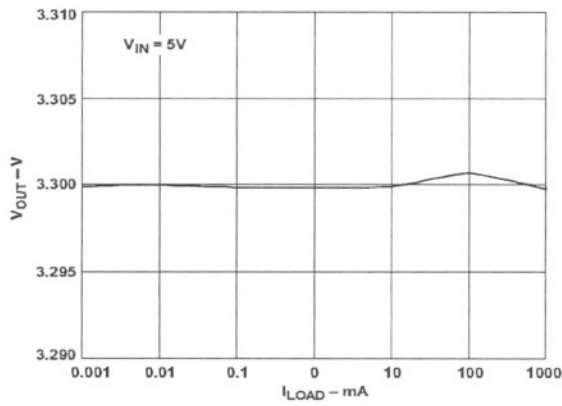

Figure 2. V_{OUT} vs. I_{LOAD} ($V_{IN} = 5V$)

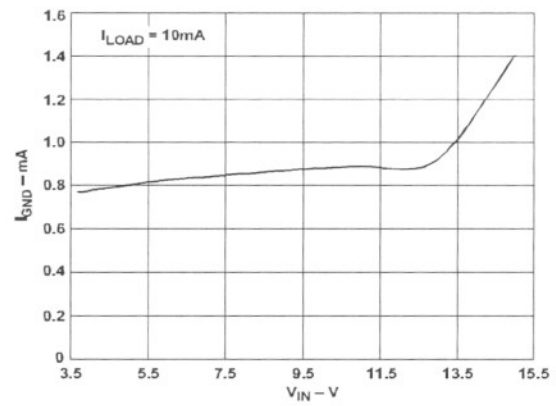

Figure 5. I_{GND} vs. V_{IN} ($I_{LOAD} = 10mA$)

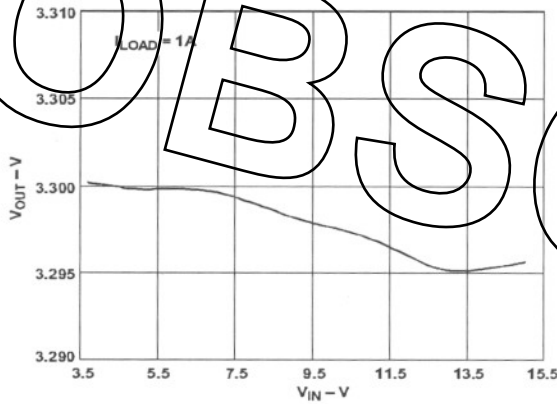

Figure 3. V_{OUT} vs. V_{IN} ($I_{LOAD} = 1A$)

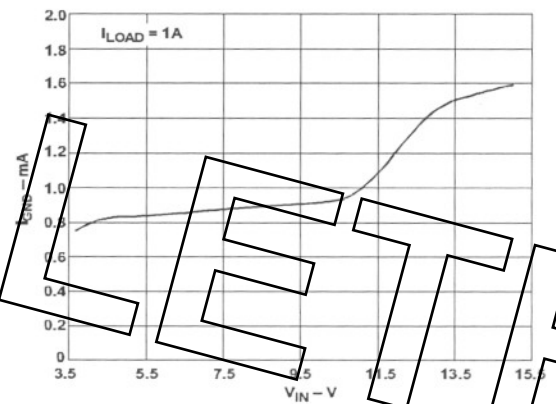

Figure 6. I_{GND} vs. V_{IN} ($I_{LOAD} = 1A$)

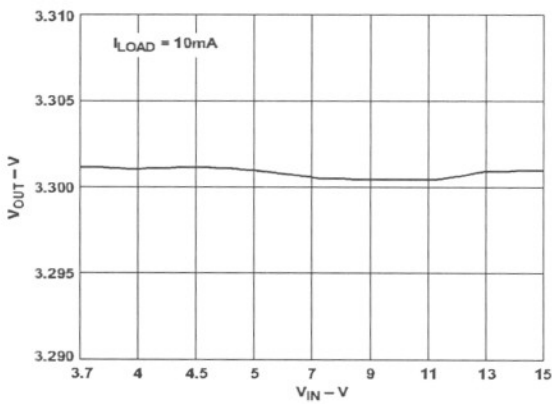

Figure 4. V_{OUT} vs. V_{IN} ($I_{LOAD} = 10mA$)

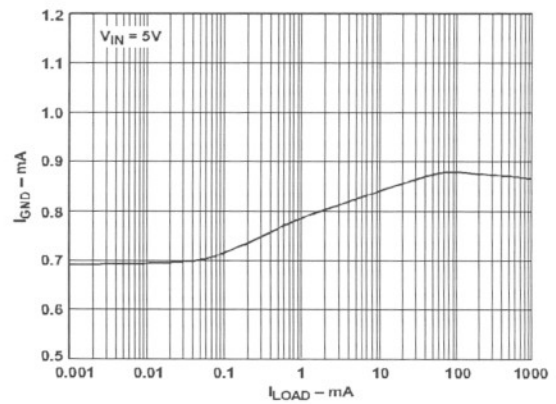

Figure 7. I_{GND} vs. I_{LOAD} ($V_{IN} = 5V$)

OBSOLETE

ADP3310

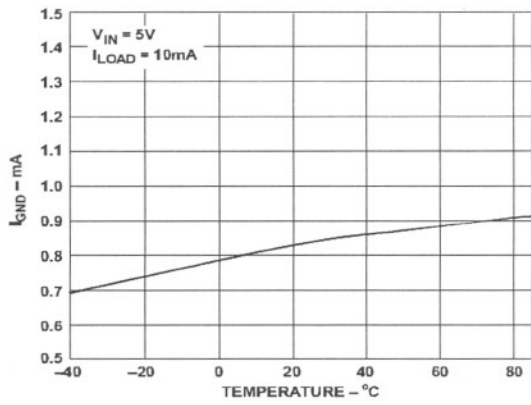

Figure 8. Quiescent Current vs. Temperature

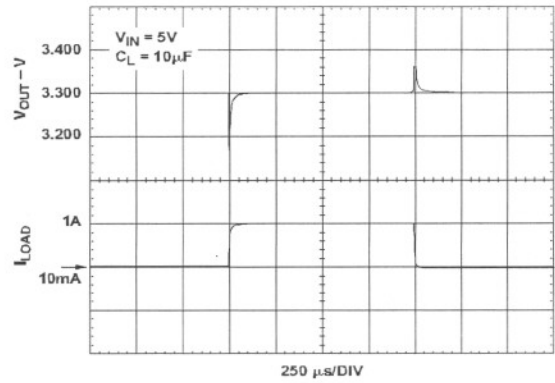

Figure 11. Load Transient Response

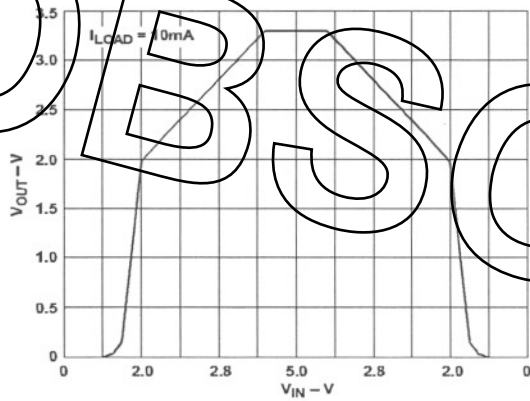

Figure 9. Power-Up/Power-Down

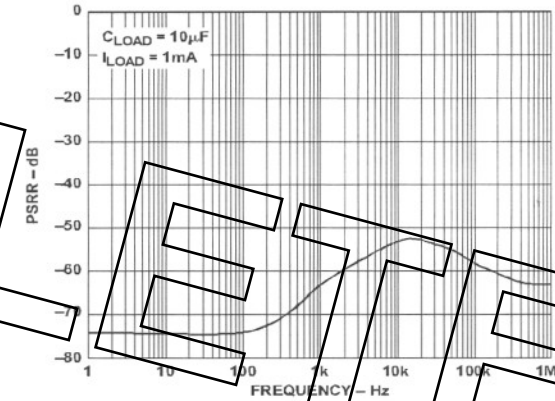

Figure 12. Ripple Rejection

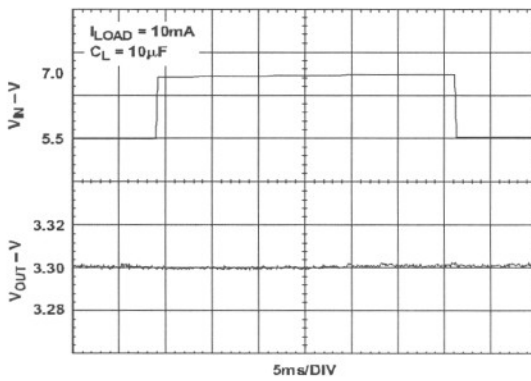

Figure 10. Line Transient Response—(10 µF Load)

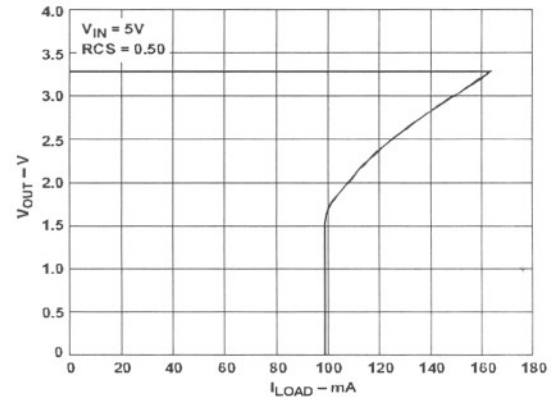

Figure 13. Foldback Current

OBSOLETE

ADP3310

APPLICATION INFORMATION

The ADP3310 is very easy to use. A P-channel power MOSFET and a small capacitor on the output is all that is needed to form an inexpensive ultralow dropout regulator. The advantage of using the ADP3310 controller is that it can drive a pass PMOS FET to provide a regulated output at high current.

FET Selection

The type and size of the pass transistor are determined by the threshold voltage, input-output voltage differential and load current. The selected PMOS must satisfy the physical and thermal design requirements. Table I shows a partial list of manufacturers providing the PMOS devices. To ensure that the maximum V_{GS} provided by the controller will turn on the FET at worst case conditions (i.e., temperature and manufacturing tolerances), the maximum available V_{GS} must be determined. Maximum V_{GS} is calculated as follows:

$$(1) V_{GS} = V_{IN} - V_{BE} - I_{OMAX} \times R_S$$

I_{OMAX} = Maximum Output Current
 R_S = Current Sense Resistor
 $V_{BE} \sim 0.7$ V (Room Temp)
 ~ 0.5 V (Hot)
 ~ 0.9 V (Cold)

For Example: $V_{IN} = 5$ V, $V_O = 3.3$ V and $I_{OMAX} = 3$ A,
 $V_{GS} = 5$ V - 0.7 V - 3 A \times 11 m Ω = 4.27 V

Equation (1) applies to a gate-to-source voltage less than the gate to source clamp voltage.

$$(2) V_{DS} = V_{IN} - V_O$$

$$V_{DS} = 5$$
 V - 3.3 V = 1.7 V

If $V_{IN} \leq 5$ V, logic level FET should be considered.
 If $V_{IN} > 5$ V, either logic level or standard MOSFET can be used.

The difference between V_{IS} and V_{OUT} (V_{DS}) must exceed the voltage drop due to the load current and the ON resistance of the FET. As a safety margin, it is recommended to use a MOSFET with a V_{GS} at least 1.5 times lower than the calculated V_{GS} value from Equation 1. Also, in the event the circuit is shorted to ground, the MOSFET must be able to conduct the maximum short circuit current. The selected MOSFET must satisfy these criteria; otherwise, a different pass device should be used. If the FET data is not available in the catalogue, contact the FET manufacturer.

Thermal Design

The maximum allowable thermal resistance between the FET junction and the highest ambient temperature must be taken into account to determine the type of FET package used. One square inch of PCB copper area as heatsink yields a typical $\theta_{JA} \sim 60^\circ\text{C/W}$ for the SOT-223 package and $\theta_{JA} \sim 50^\circ\text{C/W}$ for the SO-8 package. For substantially lower thermal resistances, D²PAK or TO-220 type of packages are recommended.

For normal applications, the FET can be directly mounted to the PCB. But, for higher power applications, an external heat sink is required to satisfy the θ_{JA} requirement and provide adequate heatsink. Calculating thermal resistance for $V_{IN} = 5$ V, $V_O = 3.3$ V, and $I_O = 3$ A:

$$\theta_{JA} = \frac{T_J - T_{AMBMAX}}{(V_{DSMAX} \times I_{OMAX})}$$

T_J = Junction Temperature
 T_{AMBMAX} = Maximum Ambient Temperature

V_{DSMAX} = Maximum Drain to Source Voltage
 I_{OMAX} = Maximum Output Current

$$\theta_{JA} = \frac{125 - 50}{1.7 \times 3} = 14.7^\circ\text{C/W}$$

For such a low θ_{JA} , a P-channel FET from Fairchild, such as NDP6020P in a heatsink mountable TO-220 package, is required. The required external heatsink is determined as follows:

$\theta_{CA} = \theta_{JA} - \theta_{JC}$
 θ_{CA} = Case-to-Ambient Thermal Resistance
 θ_{JA} = Junction-to-Ambient Thermal Resistance
 θ_{JC} = Junction-to-Case Thermal Resistance
 $\theta_{JC} = 2^\circ\text{C/W}$ for NDP6020P
 $\theta_{CA} = 14.7^\circ\text{C/W} - 2^\circ\text{C/W} = 12.7^\circ\text{C/W}$

For a safety margin, select a heatsink with a θ_{CA} less than half of the value calculated above to allow extended duration of short circuit. In a natural convection environment, a large heatsink such as 3" length of Type 63020 extrusion from Aavid Engineering is required.

External Capacitors

The ADP3310 is stable with virtually any good quality capacitors (anyCAPSM), independent of the capacitor's minimum ESR (Effective Series Resistance) value. The actual value of the capacitor and its associated ESR depends on the g_m and capacitance of the external PMOS device. A 10 μF capacitor at the output is sufficient to ensure stability for up to 10 A output current. Larger capacitors can be used if high output current surges are anticipated. Extremely low ESR capacitors (ESR=0) such as multilayer ceramic or OSCON are preferred because they offer lower ripple on the output. For less demanding requirements, a standard tantalum or even an aluminum electrolytic is adequate. However, if an aluminum electrolytic is used, be sure it meets the temperature requirements because aluminum electrolytic has poor performance over temperature.

Shutdown Mode

Applying a TTL high signal to the EN pin or tying it to the input pin will enable the output. Pulling this pin low or tying it to ground will disable the output. In shutdown mode, the controller's quiescent current is reduced to less than 1 μA .

Gate-to-Source Clamp

An 8 V gate-to-source voltage clamp is provided to protect the MOSFET in the event the output is suddenly shorted to ground. This allows the use of the new, low on-state resistance ($R_{DS(ON)}$) FETs.

Short Circuit Protection

The power FET is protected during short circuit conditions with a foldback type of current limiting which significantly reduces the current.

Current Sense Resistor

Current limit is achieved by setting an appropriate current sense resistor (R_S) across the current limit threshold voltage. Current limit sense resistor R_S is calculated as follows:

$$R_S = \frac{0.05}{(1.5 \times I_O)}$$

anyCAP is a trademark of Analog Devices, Inc.

ADP3310

Current Limit Threshold Voltage = 0.05 V
 Safety Factor = 1.5
 I_O = Output Current

R_S is not needed in circuits that do not require current limiting. In that case, the I_S pin must be tied to the input pin.

The simplest and cheapest sense resistor for high current applications, (i.e., Figure 1) is a PCB trace. The temperature dependence of the copper trace and the thickness tolerances of the trace must be taken into account in the design. The resistivity of copper has a positive temperature coefficient of $+0.39\%/^{\circ}\text{C}$. Copper's Tempco in conjunction with the proportional-to-absolute temperature (PTAT) current limit voltage can provide an accurate current limit. Table II provides the resistance value for PCB copper traces. Alternately, an appropriate sense resistor such as surface mount sense resistors available from KRL can be used.

PCB-Layout Issues

For optimum voltage regulation, place the load as close as possible to the device's V_{OUT} and GND pins. It is recommended to use dedicated PCB traces to connect the MOSFET's drain to the positive terminal and GND to the negative terminal of the load to avoid voltage drops along the high current carrying PCB traces.

Application Circuits

Typical 3 A LDO Circuit

The ADP3310 and a power MOSFET can be used to power the new generation of CPUs and microprocessors from the standard +5 V supply at a very low cost (Figure 14). This circuit provides low dropout, fast switching and high switching load current from 0 A to 3 A. Due to the high switching load current, capacitors with high ripple current carrying capability, such as OSCON or special tantalum capacitors from Sprague (593D), are recommended for the output.

Table II. Printed Circuit Copper Resistance

Conductor Thickness	Conductor Width In	Resistance mΩ/In
1/2 oz/ft ² (18 μm)	0.025	39.3
	0.050	19.7
	0.100	9.83
	0.200	4.91
	0.500	1.97
1 oz/ft ² (35 μm)	0.025	19.7
	0.050	9.83
	0.100	4.91
	0.200	2.46
	0.500	0.98
2 oz/ft ² (70 μm)	0.025	9.83
	0.050	4.91
	0.100	2.46
	0.200	1.23
	0.500	0.49
3 oz/ft ² (106 μm)	0.025	6.5
	0.050	3.25
	0.100	1.63
	0.200	0.81
	0.500	0.325

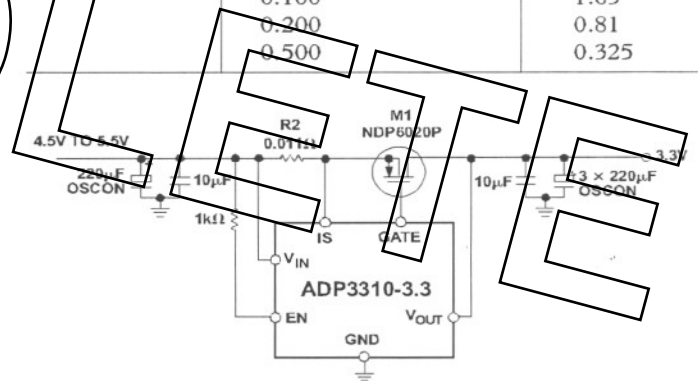

Figure 14. Typical 3 A Low Dropout Regulator Circuit

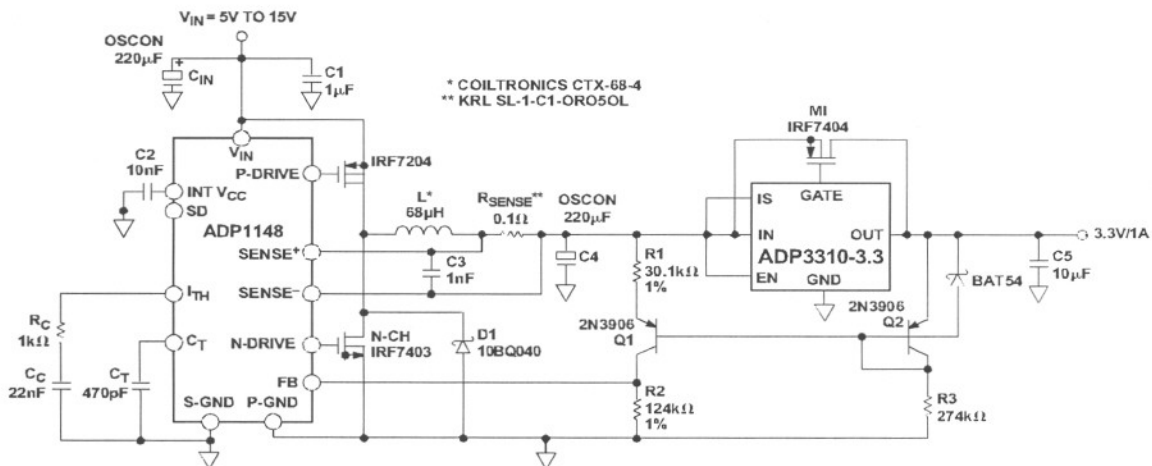

Figure 15. High Current Post Regulator with SOIC PMOS

ADP3310

High Current Post Regulator with SOIC PMOS

Post regulation for a switch-mode supply (Figure 15) can be implemented with a PMOS in an SO-8 package to provide a significant reduction in peak-to-peak ripple voltage. A constant dropout voltage in conjunction with low quiescent current yield a more efficient voltage regulator that can significantly extend battery life. The bottom waveform of Figure 16 is the output of the switching regulator. The top waveform is the output of the post regulator.

In applications where cost is a higher concern than efficiency, a resistor divider can be used to provide feedback instead of the current mirror. Power efficiency is lower in cases of light loads.

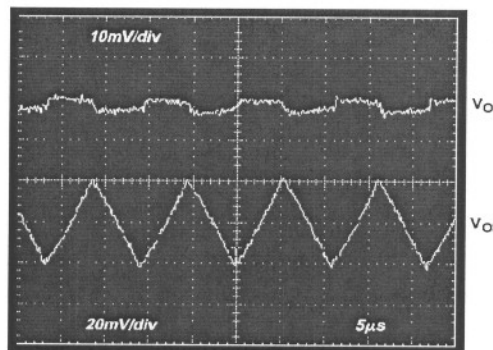
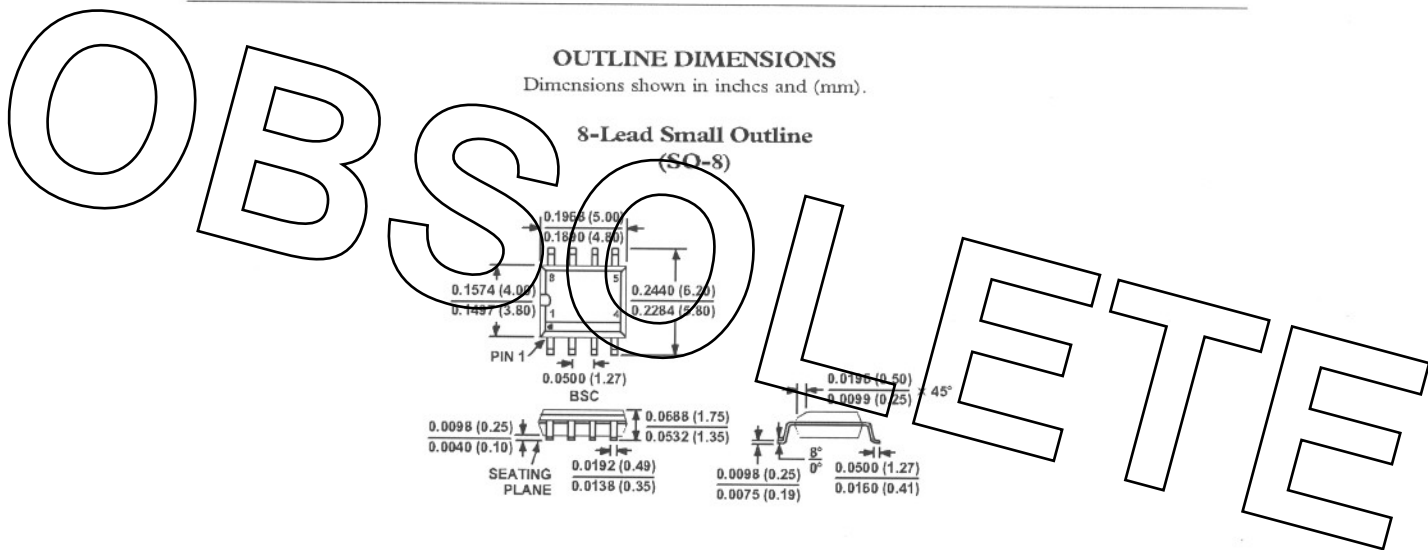

Figure 16. Pre-and Post-Regulated Voltage



C2982a-0-12/99 (rev. A)

PRINTED IN U.S.A.

OTC ALERT

GOLD...GOLD...GOLD

USCorp HAS STRUCK GOLD...

SYMBOL:	USCS
Recent Price	\$0.35
Market Cap:	9,000,000

ALERT... Symbol: USCS Recent Price: 0.35

THE BUSINESS

It has been over twenty years since the price of gold has shown such exciting upside action and potential. It has been just as long since conditions were right for an American Company to develop an American Gold asset. The **Twin Peaks Mine** in West-Central Arizona is such a property. The Twin Peaks Mines is about 80 miles North West of Phoenix, Arizona and 4 miles south-east of Bagdad, Arizona. Bagdad is the site of the Phelps Dodge open pit mine. Phelps Dodge employs 515 people, primarily producing copper (247 million pounds in 2000), molybdenum, gold and silver.

USCorp is a fully reporting public corporation trading on the Over The Counter Bulletin Board, Symbol: USCS. USCorp's wholly owned subsidiary USMetals, Inc., owns the mining leases to 141 lode mining claims that constitute the Twin Peaks Mine. USCorp is an exploration and development company that has **begun test production.**

1985 - Appraisal and Valuation

The Late Mr. N. H. Carouso, former President of Geo-Processing, Inc., was retained to make an economic valuation of the Twin Peaks Property. **The following is a statement from Mr. Carouso's report:** "It is felt that an early cash flow can be expected. Based on mining to a depth of 100 feet, the gross dollar potential using only 30% of the areas evaluated, **could be \$280,836,000.00.** Mr Caruso's report was based on a spot price of \$325/oz / gold and \$6.00/oz. / silver."

2002 - Appraisal and Valuation

Mr. Scott Spooner, Senior Geologist of Spooner & Associates reported 3,690,782 estimated reserve ounces of gold. Spooner reported silver estimated reserves at approximately 18,450,000 ounces at five ounces of silver for every ounce of gold. These estimates verify Caruso's **proven** findings.

Recent News Releases

7-22-03 - USCorp announces proven drilling program confirms proven gold reserves.

8-06-03 - USCorp announces completion of Twin Peaks Gold Mine "Phase One Plan of Operations"

USCorp's mission is to become a large and successful commercially producing, metals and minerals company. USCorp's growth strategy is geared towards additional future property acquisitions.

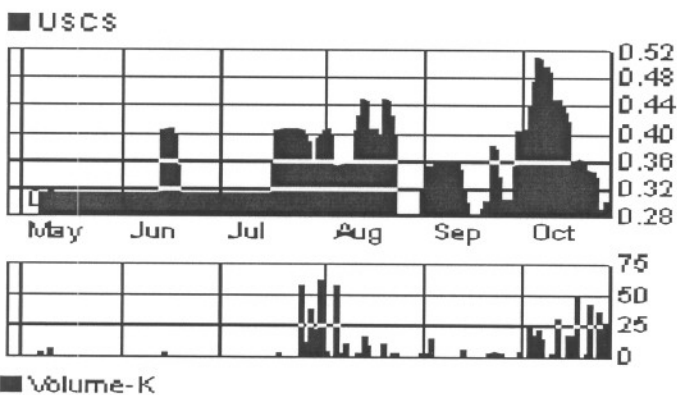

Disclaimer The publications and advertisements are not endorsements, recommendations, analysis or advisories of any nature by the Publisher. An affiliate of My Shareholders Inc does not give tax or investment advice or advocate the purchase or sale of any security or investment. An offer to buy or sell can be made only with accompanying disclosure documents and only in the states and provinces for which they are approved. It is strongly recommended that any purchase or sale decision be discussed with a financial adviser or broker prior to completing any such purchase or sale decision. We are not registered investment advisers, or broker-dealers, or members of any financial regulatory bodies. Since we receive compensation from some of the advertised companies there is an inherent conflict of interest in our statements and opinions and such statements and opinions cannot be considered independent. Compensation: In keeping with Section 17b of the Securities Act of 1933 this information was approved and provided by payee/ representatives...no warrants are made. An affiliate of My shareholder purchased 250,000 shares of USCS from Mike Lee who is a third party non affiliate Be aware of an inherent conflict of interest resulting from such compensation due to our intent to profit from the liquidation of these shares in the open market to cover the costs of publication and marketing. These materials may contain forward-thinking statements.

To Be Removed from our Database, Call Toll-Free: 1-888-528-8863.

Wall Street Stock Alerts

Symbol OTCPK:	EMTI.PK
Recent Price	\$0.215
Target Price :	\$1.00

STRONG BUY

News Flash:

Alarmingly, kidnapping in North America has risen to an all-time high of over 800 persons per day! Kinder Finder and Gadget Finder addresses an urgent societal need that is vital to every parent or guardian. Do not miss this trade!

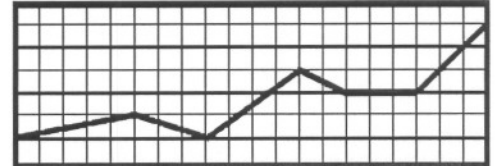

SYMBOL: EMTI.PK

Environmental Tech • OTCPK: EMTI.PK • Recent Price: \$ 0.215

Company Info: EMTI.PK

Environmental Technologies' products currently being developed for specific market applications include short- and long-range detection devices that can be hidden in clothing, or on valuables, and that will emit signals to loved ones or owners of articles. The technology provides a capability that is ideal for families living in fear of their children being kidnapped, or of having elderly family members, suffering from dementia or any other form of memory loss, wander off aimlessly without their loved one's knowledge.

Alarmingly, kidnapping in North America has risen to an all-time high of over 800 persons per day! Another promising application, "Find-A-Shipment," will enable real-time tracking and up-to-the-minute delivery progress for shippers needing to maximize their just-in-time delivery service.

The Company also announced recently that it is pursuing the introduction of an embedded device in credit cards, passports, etc., that will pinpoint the location of lost or stolen cards in real time. We believe that our product range admirably addresses these growing security needs, and that the marketplace will enthusiastically welcome the Finder technology.

The technology provides a capability that is ideal for families living in fear of their children being kidnapped, or of having elderly family members, suffering from dementia or any other form of memory loss, wander off aimlessly without their loved one's knowledge.

BREAKING NEWS!!

TUCSON, Ariz., Sept. 9, 2003 (PRIMEZONE) Environmental Technologies Inc. (Other OTC:[EMTI.PK News](#)) is pleased to announce they have received the prototypes for its first two **FINDER SECURITY DEVICES**, the **Gadget Finder** and **Kinder Finder**, ahead of schedule, following which the devices will undergo independent testing this fall.

The Company is engaged in discussions with several recognized testing/engineering firms and expects to enter into an agreement by month-end whereby formal testing will be carried out preparatory to the commencement of production design and engineering.

Gadget Finder -- represents an inexpensive way to prevent the loss or theft of portable electronic gadgets such as cell phones, PDAs, laptops, CD players, etc. The device, which encompasses leading-edge GPS, wireless, and RFID technology, allows the owner to instantly locate the missing device using a pocket-held wireless unit. As well, an audible beep will alert the owner whenever the device reaches a stipulated distance (i.e., 30 feet) from the owner.

Kinder Finder -- consists of a tiny device hidden on a child's person that will allow the parent to pinpoint the location of that child to within 1,000 square feet anywhere in the world at any time. If a parent and child get separated in public, the parent can immediately determine, from a pocket-held unit or medallion, the direction in which the child has wandered off, and the distance to the child. With kidnappings and reports of missing children having risen to an all time high in the US, Kinder Finder addresses an urgent need that is vital to every parent or guardian.

Wall Street Stock Alerts publishes reports providing information on selected companies. WSSA is not a registered investment advisor or broker-dealer. This report is provided as an information service only, and the statements and opinions in this report should not be construed as an offer or solicitation to buy or sell any security. WSSA accepts no liability for any loss arising from an investor's reliance on or use of this report. An investment in EMTI is considered to be highly speculative and should not be considered unless a person can afford a complete loss of investment. Stock Alerts, LLC has received \$20,000 cash from a non-affiliated third party, for the publication and circulation of this report. This report contains forward-looking statements, which involve risks, and uncertainties that may cause actual results to differ materially from those set forth in the forward-looking statements. Copyright 2003 by WSSA. All rights reserved.

To be removed from our database, call toll free at 1-888-399-1563