

THIS DRAWING IS UNPUBLISHED. RELEASED FOR PUBLICATION 20
 © COPYRIGHT 20 BY - ALL RIGHTS RESERVED.

LOC	DIST	REVISIONS			
P	LTR	DESCRIPTION	DATE	DWN	APVD
-	-	A8	ECR-18-004630	29MAR2018	SC BH

TABLE 1

NO.	NAME	MATERIAL
1	POST CONTACT	BRASS, FINISH; TIN PLATING
2	HDR HOUSING	PA 66 GF UL94 V-0

KINK POSITION TABLE 2

POSITION	KINK A	KINK B
4	1,2	3,4
6	1,3	4,6
8	1,4	5,8
10	1,5	6,10
12	1,6	7,12
14	1,7	8,14

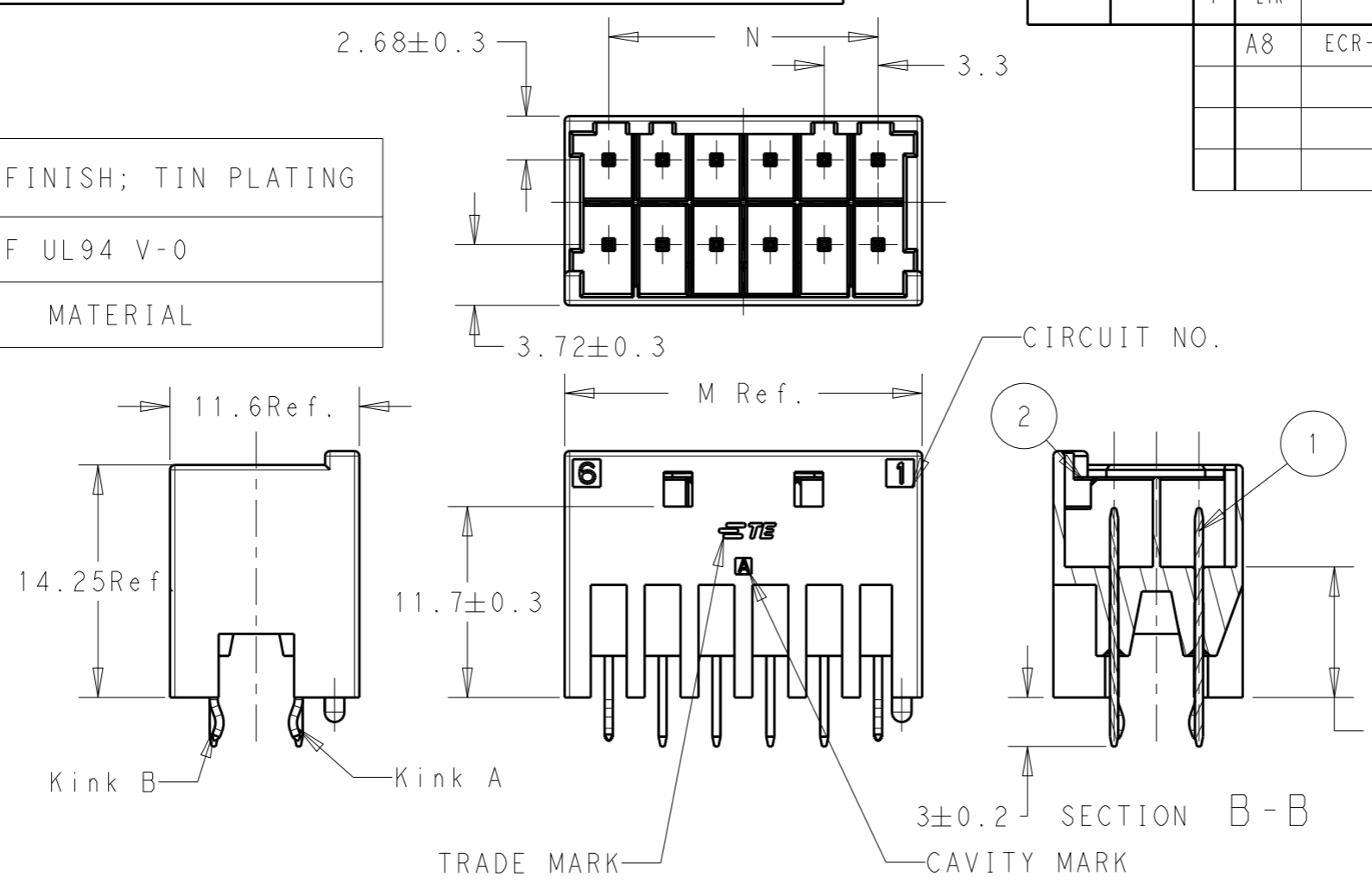

- NOTES:
- 1. RECOMMENDED PCB LAYOUT
 - 2. APPLICABLE PCB THICKNESS 1.6MM
 - 3. MATERIAL SEE TABLE 1
 - 4. KINK FORM SEE TABLE 2
 - 5. MATING PLUG HOUSING SEE TABLE 3
 - 6. PIN DIMENSION
 - 7. ADDITIONAL REQUESTS FOR P/N: 5-1971906-7, 6-1971906-7, 5-1971906-6
 - 8. ADDITIONAL REQUESTS FOR P/N: 5-1971906-3, 5-1971906-5, 6-1971906-5:
 - 9. PRELIMINARY-NOT FOR PRODUCTION

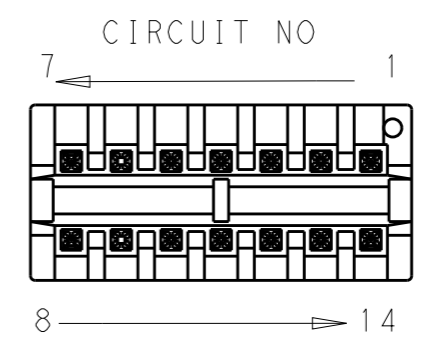
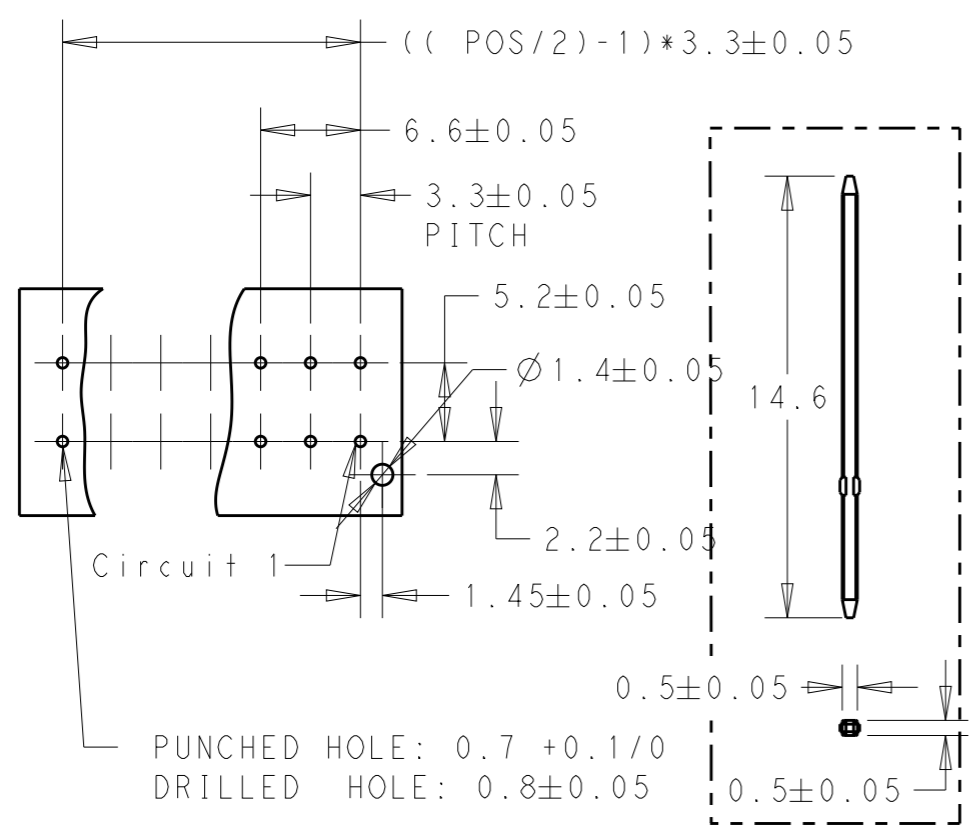

1 RECOMMENDED PCB LAYOUT

6 Pin

THIS DRAWING IS A CONTROLLED DOCUMENT.		DWN	LZH	08JAN2013	 TE Connectivity	NAME		NEXT GENERATION G13.3 HEADER ASSEMBLY 2 ROW	
DIMENSIONS: mm		CHK	HAPYE.WU	08JAN2013		PRODUCT SPEC		108-106094	
TOLERANCES UNLESS OTHERWISE SPECIFIED:		APVD	YH.MAO	08JAN2013		APPLICATION SPEC		114-106094	
0 PLC ±- 1 PLC ±0.5 2 PLC ±0.13 3 PLC ±0.013 4 PLC ±0.0001 ANGLES ±-		MATERIAL		WEIGHT		SIZE		CAGE CODE	
		FINISH		Customer Drawing		SCALE		SHEET	
						A3		00779	
						G=		1971906	
						RESTRICTED TO			
						SCALE		SHEET	
						5:2		1 OF 3	
								REV	
								A8	

THIS DRAWING IS UNPUBLISHED.

RELEASED FOR PUBLICATION

20

LOC -

DIST -

REVISIONS

© COPYRIGHT 20 BY -

ALL RIGHTS RESERVED.

P	LTR	DESCRIPTION	DATE	DWN	APVD
		SEE SHEET 1			

5-1971906-7:
KEY A, NATURAL

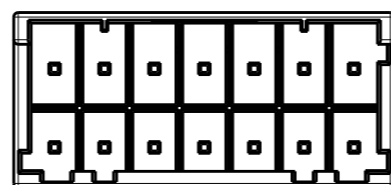
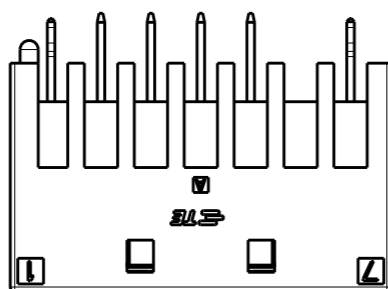

KEYING A

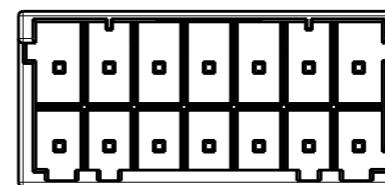

KEYING B

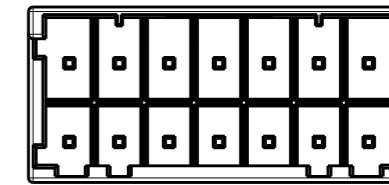

KEYING C

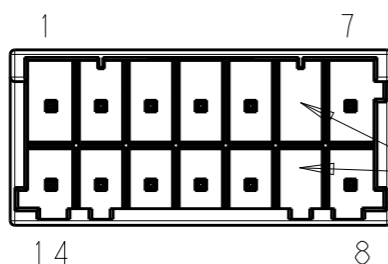

NO PIN
7

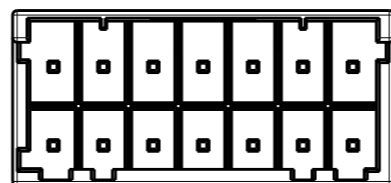

KEYING D

6-1971906-7:
KEY B, BLUE

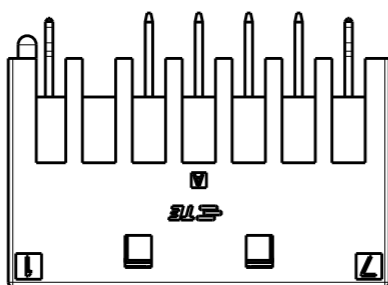

5-1971906-6:
KEY A, NATURAL

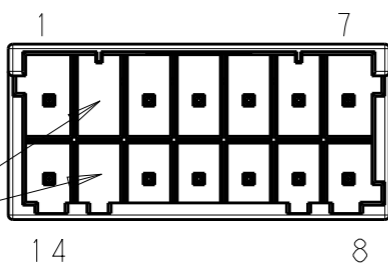
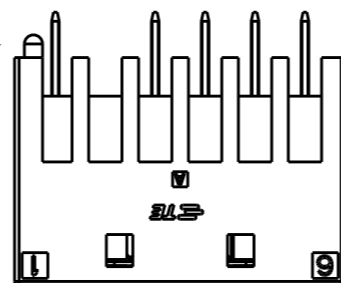

NO PIN
7

NO PIN
7

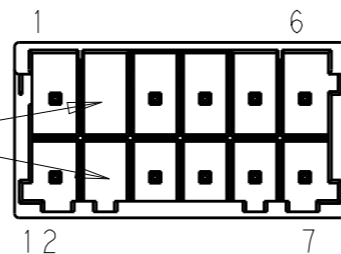
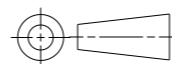

TABLE 3 5

MATING PLUG P/N	COLOR	KEYING	N	M	POS	PART NO.
2-1971905-7	BLUE	B	19.8	25.2	14	6-1971906-7
1-1971905-7	NATURAL	A			14	5-1971906-7
4-1971905-7	YELLOW	D			14	4-1971906-7
3-1971905-7	RED	C			14	3-1971906-7
2-1971905-7	BLUE	B	16.5	21.9	14	2-1971906-7
1-1971905-7	NATURAL	A			14	1-1971906-7
1-1971905-6	NATURAL	A			12	5-1971906-6
4-1971905-6	YELLOW	D			12	4-1971906-6
3-1971905-6	RED	C	16.5	21.9	12	3-1971906-6
2-1971905-6	BLUE	B			12	2-1971906-6
1-1971905-6	NATURAL	A			12	1-1971906-6
4-1971905-5	YELLOW	D			10	4-1971906-5
3-1971905-5	RED	C	13.2	18.6	10	3-1971906-5
1-1971905-5	BLUE	B			10	2-1971906-5
1-1971905-5	NATURAL	A			10	1-1971906-5
4-1971905-4	YELLOW	D			8	4-1971906-4
3-1971905-4	RED	C	9.9	15.3	8	3-1971906-4
2-1971905-4	BLUE	B			8	2-1971906-4
1-1971905-4	NATURAL	A			8	1-1971906-4
4-1971905-3	YELLOW	D			6	4-1971906-3
3-1971905-3	RED	C	6.6	12	6	3-1971906-3
2-1971905-3	BLUE	B			6	2-1971906-3
1-1971905-3	NATURAL	A			6	1-1971906-3
4-1971905-2	YELLOW	D			4	4-1971906-2
3-1971905-2	RED	C	3.3	8.7	4	3-1971906-2
2-1971905-2	BLUE	B			4	2-1971906-2
1-1971905-2	NATURAL	A			4	1-1971906-2

THIS DRAWING IS A CONTROLLED DOCUMENT.

DIMENSIONS:
mm



TOLERANCES UNLESS OTHERWISE SPECIFIED:

- 0 PLC ±-
- 1 PLC ±0.5
- 2 PLC ±0.13
- 3 PLC ±0.013
- 4 PLC ±0.0001
- ANGLES ±-

MATERIAL -

FINISH -

DWN 08JAN2013

LZH

CHK 08JAN2013

HAPYE.WU

APVD 08JAN2013

YH.MAO

PRODUCT SPEC

108-106094

APPLICATION SPEC

114-106094

WEIGHT -

Customer Drawing



TE Connectivity

NAME
NEXT GENERATION G13.3
HEADER ASSEMBLY 2 ROW

SIZE CAGE CODE DRAWING NO RESTRICTED TO

A3 00779 C-1971906

SCALE - SHEET 2 OF 3 REV A8

THIS DRAWING IS UNPUBLISHED.

RELEASED FOR PUBLICATION

20

© COPYRIGHT 20

BY -

ALL RIGHTS RESERVED.

LOC -

DIST -

REVISIONS

P

LTR

DESCRIPTION

DATE

DWN

APVD

SEE SHEET 1

5-1971906-3:
KEY A, NATURAL

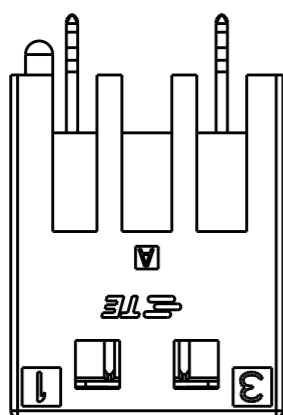

1 3

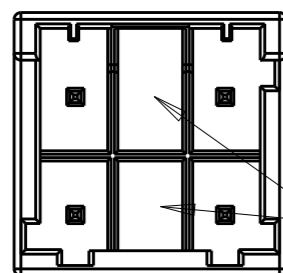

6 4

NO PIN



5-1971906-5:
KEY A, NATURAL

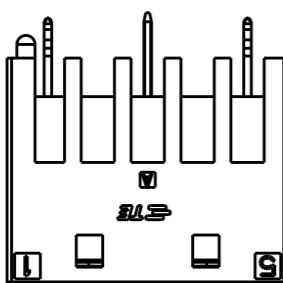

1 5

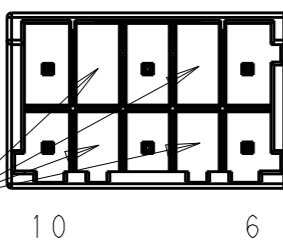

10 6

NO PIN



6-1971906-5:
KEY B, BLUE

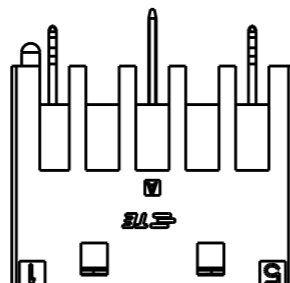

1 5

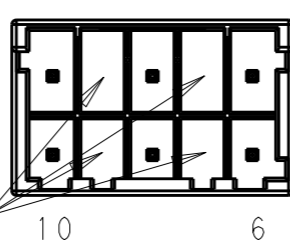

NO PIN

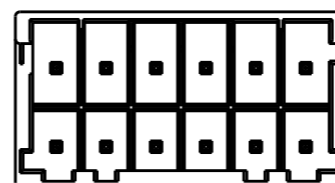

KEYING A

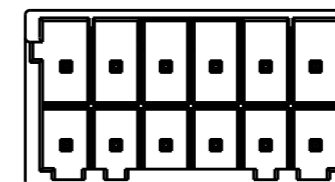

KEYING B

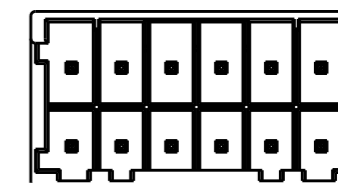

KEYING C

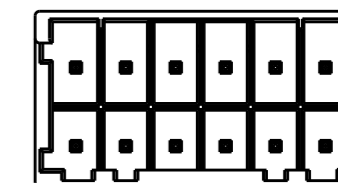

KEYING D

TABLE 3

2, 4, 7, 9	2-1971905-5	BLUE	B	13.2	18.6	10	6-1971906-5		
2, 4, 7, 9	1-1971905-5	NATURAL	A	13.2	18.6	10	5-1971906-5		
2, 5	1-1971905-3	NATURAL	A	6.6	12	6	5-1971906-3		
POS NUMBER REMOVED	MATING PLUG P/N	COLOR	KEYING	N	M	POS	PART NO.		

THIS DRAWING IS A CONTROLLED DOCUMENT.

DIMENSIONS:
mm

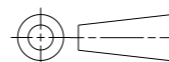

TOLERANCES UNLESS OTHERWISE SPECIFIED:

- 0 PLC ±-
- 1 PLC ±0.5
- 2 PLC ±0.13
- 3 PLC ±0.013
- 4 PLC ±0.0001
- ANGLES ±-

MATERIAL -

FINISH -

DWN 08JAN2013

LZH

CHK 08JAN2013

HAPYE.WU

APVD 08JAN2013

YH.MAO

PRODUCT SPEC

108-106094

APPLICATION SPEC

114-106094

WEIGHT -

Customer Drawing



TE Connectivity

NAME

NEXT GENERATION G13.3
HEADER ASSEMBLY 2 ROW

SIZE

CAGE CODE

DRAWING NO

RESTRICTED TO

A3

00779

C=1971906

SCALE 5:2

SHEET 3 OF 3

REV A8