

REVISIONS				
P	LTR	DESCRIPTION	DATE	APVD
C6		REVISED PER ECN-23-242776	13DEC2023	WLS VS

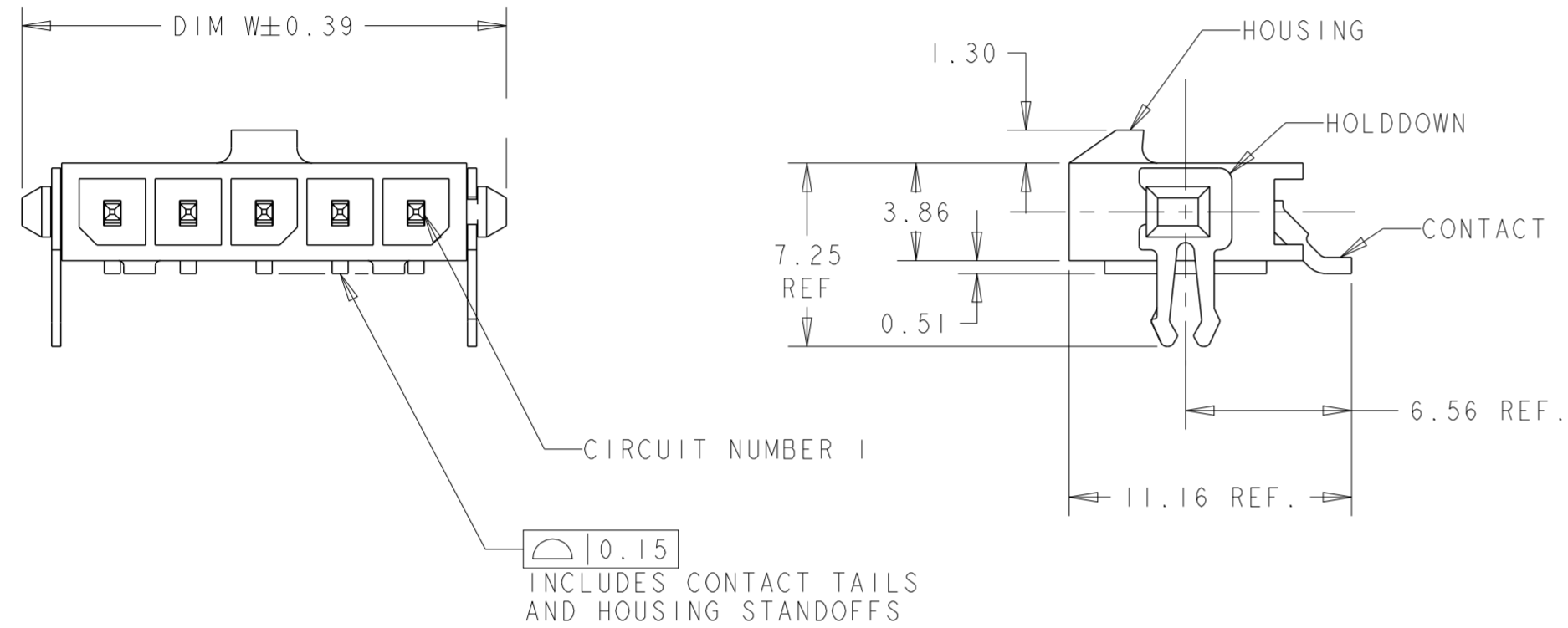

- 1 MATERIAL: HOUSING - UL 94V-0 RATED HIGH TEMP NYLON, COLOR BLACK.
CONTACTS - BRASS
HOLDDOWNS - PHOSPHOR BRONZE.
- 2 RECOMMENDED PC BOARD THICKNESS OF 1.57.
- 3 PLATING: CONTACTS - 2.54µm MINIMUM MATTE TIN OVER 1.27µm MINIMUM NICKEL.
HOLDDOWNS - 2.54µm MINIMUM MATTE TIN OVER 1.27µm MINIMUM NICKEL.
- 4 COUNTERPART RECOMMENDED IS PN 1445022 OR 2008571 (DASH ACC. TO NUMBER OF POSITION).
- 5 FOR REELING DIRECTION AND PACKAGING TYPE, SEE SPECIFICATION 114-13000.

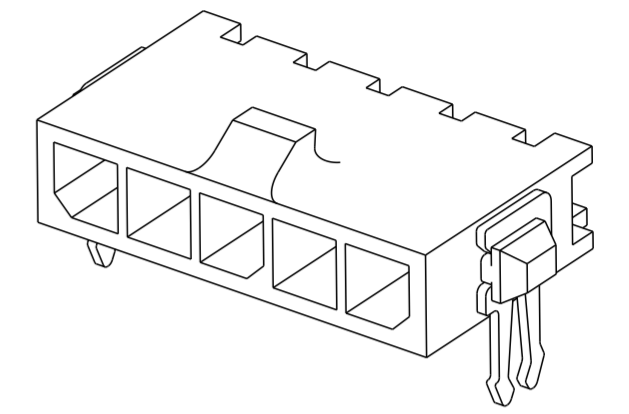
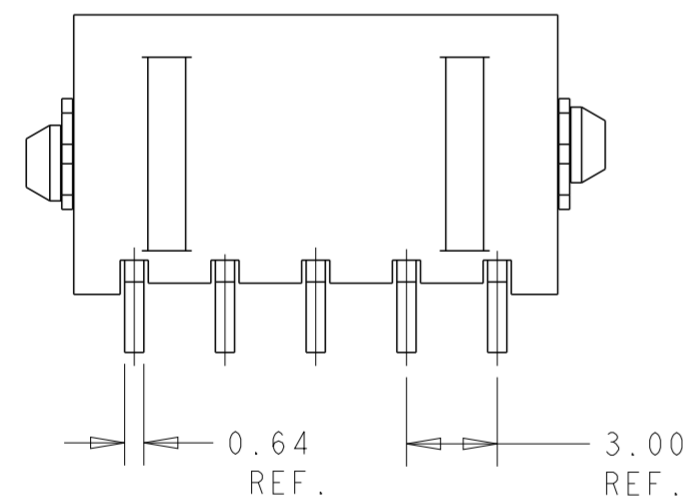

OBSOLETE	33.00	37.43	40.00	12	3-1445056-2
OBSOLETE	30.00	34.43	37.00	11	3-1445056-1
OBSOLETE	27.00	31.43	34.00	10	3-1445056-0
OBSOLETE	24.00	28.43	31.00	9	2-1445056-9
OBSOLETE	21.00	25.43	28.00	8	2-1445056-8
OBSOLETE	18.00	22.43	25.00	7	2-1445056-7
OBSOLETE	15.00	19.43	22.00	6	2-1445056-6
OBSOLETE	12.00	16.43	19.00	5	2-1445056-5
	9.00	13.43	16.00	4	2-1445056-4
	6.00	10.43	13.00	3	2-1445056-3
	3.00	7.43	10.00	2	2-1445056-2
	DIM Z	DIM V	DIM W	NO. OF POSN	PART NUMBER

THIS DRAWING IS A CONTROLLED DOCUMENT.

DIMENSIONS: mm	TOLERANCES UNLESS OTHERWISE SPECIFIED: 0 PLC ± 1 PLC ± 2 PLC ±0.13 3 PLC ± 4 PLC ± ANGLES ±1° FINISH	DWN J.ROOT 03OCT2000 CHK K.WHITAKER 13-MAR-2001 APVD K.WHITAKER 13-MAR-2001 PRODUCT SPEC 108-1836 APPLICATION SPEC 114-13000 WEIGHT -	TE Connectivity NAME RT ANGLE SURFACE MOUNT HEADER ASSY, TIN CONTACTS W/THRU HOLE HOLDDOWNS, SINGLE ROW, MICRO MATE-N-LOK™ SIZE A2 CAGE CODE 00779 DRAWING NO. C-1445056 RESTRICTED TO - SCALE 4:1 SHEET 1 OF 2 REV C6
----------------	---	--	--

CUSTOMER DRAWING

P	LTR	DESCRIPTION	DATE	DWN	APVD
-	-	SEE SHEET 1	-	-	-

2 POS.

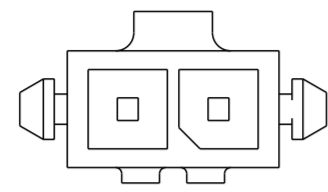

8 POS.

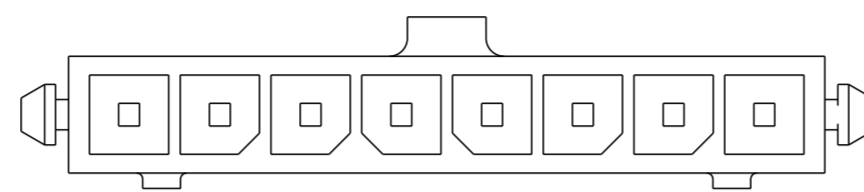

3 POS.

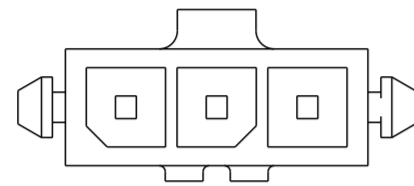

9 POS.

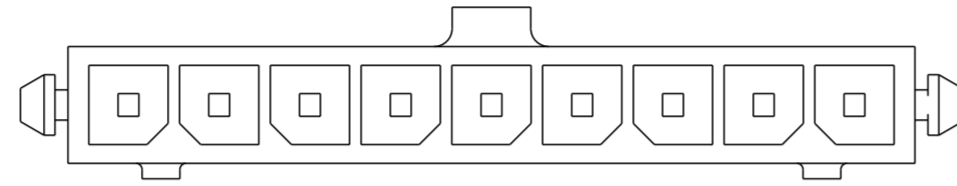

4 POS.

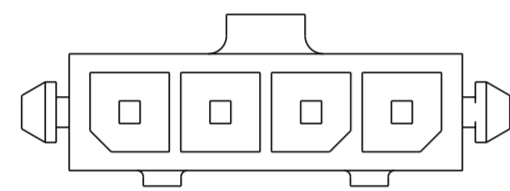

10 POS.

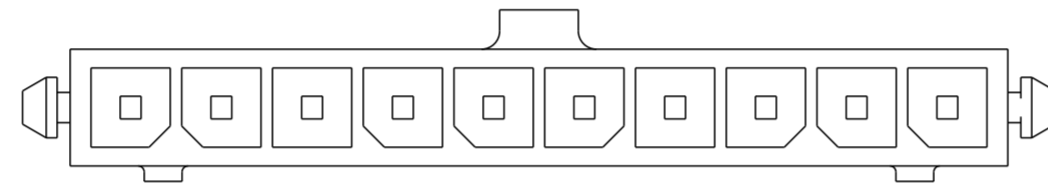

5 POS.

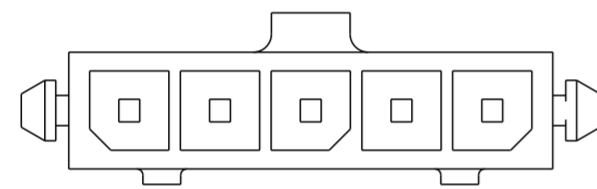

11 POS.

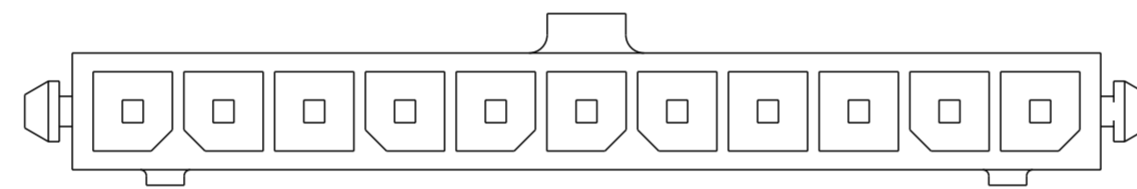

6 POS.

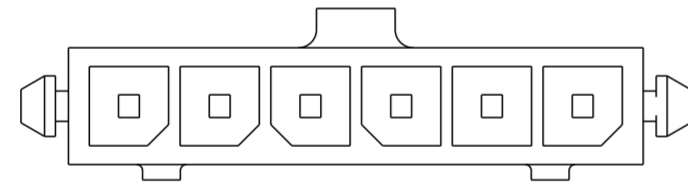

12 POS.

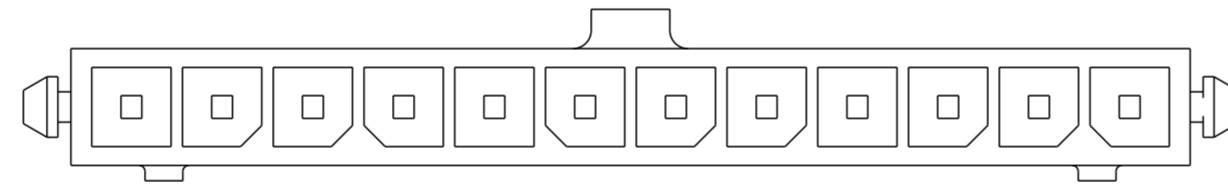

7 POS.

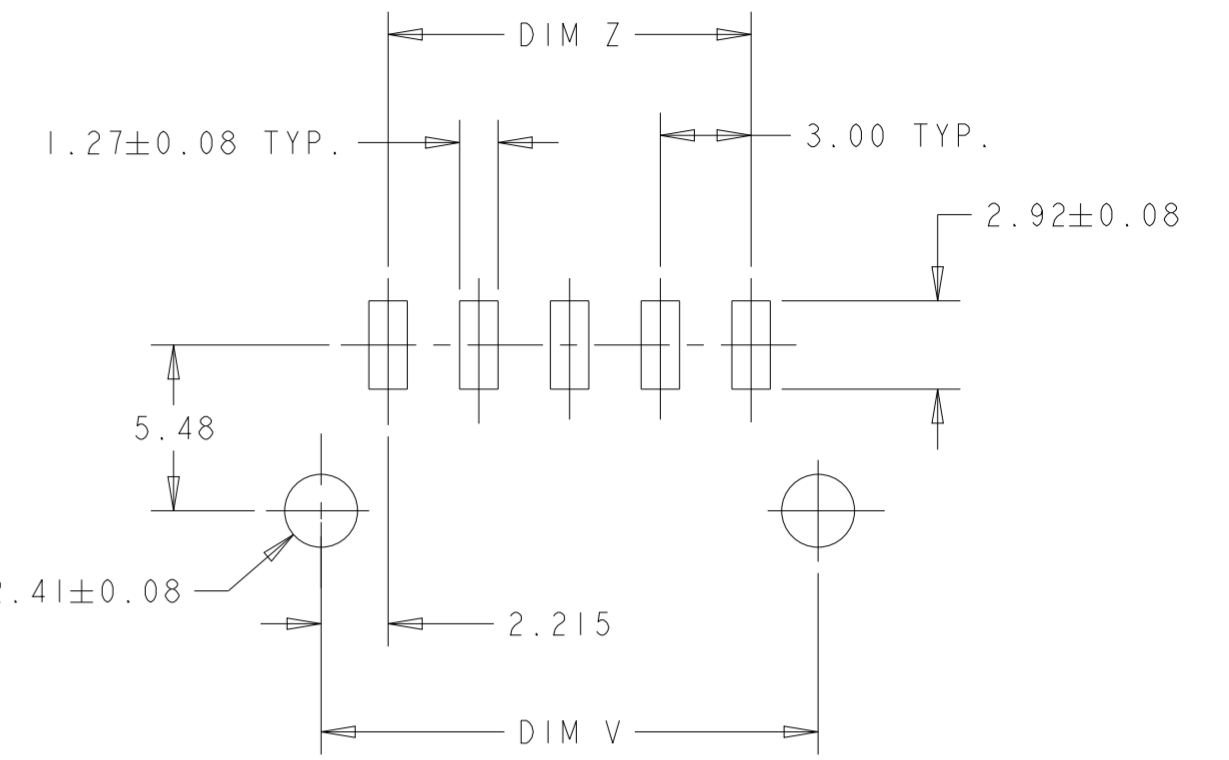
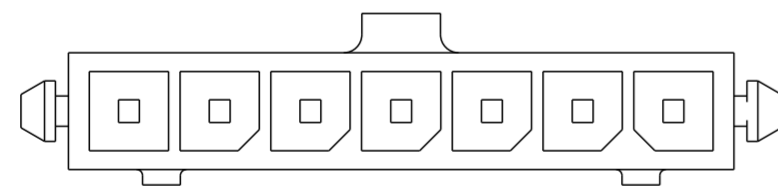

PCB LAYOUT COMPONENT SIDE $\triangle 2$

KEYING BY POSITION SIZE

THIS DRAWING IS A CONTROLLED DOCUMENT.		DWN J. ROOT 03OCT2000	TE Connectivity	
DIMENSIONS: mm		CHK K. WHITAKER 13-MAR-2001		
TOLERANCES UNLESS OTHERWISE SPECIFIED:		APVD K. WHITAKER 13-MAR-2001	NAME RT ANGLE SURFACE MOUNT HEADER ASSY, TIN CONTACTS W/THRU HOLE HOLDDOWNS, SINGLE ROW, MICRO MATE-N-LOK	
		PRODUCT SPEC 108-1836	RESTRICTED TO	
MATERIAL		APPLICATION SPEC 114-13000	SIZE A200779	CAGE CODE C-1445056
FINISH		WEIGHT	DRAWING NO	
-		-	SCALE 5:1 SHEET 2 OF 2 REV C6	
-		-	CUSTOMER DRAWING	