

207441-7 ✓ ACTIVE

AMP | AMP Metrimate

TE Internal #: 207441-7

PCB Mount Header, Vertical, Wire-to-Board, 9 Position, 5 mm [.197 in] Centerline, Fully Shrouded, Tin, Through Hole - Solder, AMP Metrimate

[View on TE.com >](#)



Connectors > PCB Connectors > PCB Headers & Receptacles

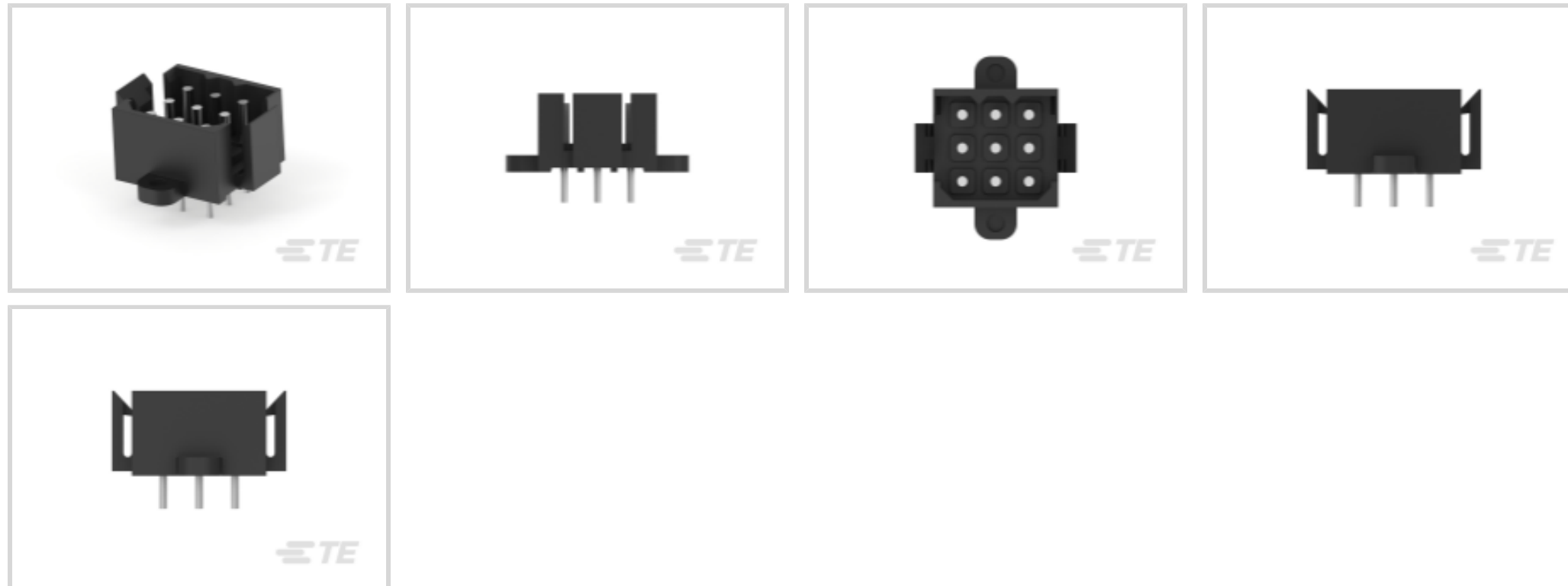

Connector System: **Wire-to-Board**

Number of Positions: **9**

Number of Rows: **3**

Centerline (Pitch): **5 mm [.197 in]**

PCB Mount Orientation: **Vertical**

Features

Product Type Features

| | |
|-----------------------------------|-----------------------|
| Connector System | Wire-to-Board |
| Header Type | Fully Shrouded |
| Sealable | No |
| Connector & Contact Terminates To | Printed Circuit Board |
| PCB Connector Assembly Type | PCB Mount Header |

Configuration Features

| | |
|----------------------------------|--------------|
| Number of Columns | 3 |
| Number of Loaded Positions | 9 |
| Connector Contact Load Condition | Fully Loaded |
| Number of Positions | 9 |
| Number of Rows | 3 |
| PCB Mount Orientation | Vertical |

Electrical Characteristics

| | |
|-------------------|---------|
| Operating Voltage | 600 VAC |
|-------------------|---------|



Body Features

| | |
|-----------------------|-------|
| Primary Product Color | Black |
|-----------------------|-------|

Contact Features

| | |
|---|--|
| PCB Contact Termination Area Plating Material Thickness | 3.81 μm [150 μin] |
| Contact Layout | Matrix |
| Mating Pin Diameter | 1.75 mm[.069 in] |
| Contact Underplating Material Thickness | 2.54 μm [100 μin] |
| Contact Mating Area Plating Material Thickness | 3.81 μm [150 μin] |
| PCB Contact Termination Area Plating Material Finish | Matte |
| Contact Mating Area Plating Material Finish | Matte |
| Contact Underplating Material | Copper |
| PCB Contact Termination Area Plating Material | Tin |
| Contact Mating Area Plating Material | Tin |
| Contact Type | Pin |
| Contact Current Rating (Max) | 7.5 A |

Termination Features

| | |
|---|-----------------------|
| Round Termination Post & Tail Diameter | .99 mm[.039 in] |
| Termination Method to Printed Circuit Board | Through Hole - Solder |

Mechanical Attachment

| | |
|--------------------------|--------------|
| Mating Alignment Type | Polarization |
| Mating Retention | With |
| PCB Mount Retention Type | Screw Mount |
| Connector Mounting Type | Board Mount |
| Mating Alignment | With |
| PCB Mount Alignment | Without |
| PCB Mount Retention | With |

Housing Features

| | |
|--------------------|---------------|
| Housing Material | PA 66 |
| Centerline (Pitch) | 5 mm[.197 in] |

Dimensions

| | |
|------------------|-------------------|
| Connector Length | 17.78 mm[.7 in] |
| Connector Height | 11.79 mm[.464 in] |



| | |
|-----------------|-------------------|
| Connector Width | 18.72 mm[.737 in] |
|-----------------|-------------------|

| | |
|--------------------|---------------|
| Row-to-Row Spacing | 5 mm[.197 in] |
|--------------------|---------------|

Usage Conditions

| | |
|-----------------------------|----------------------------|
| Operating Temperature Range | -55 – 130 °C[-67 – 266 °F] |
|-----------------------------|----------------------------|

Operation/Application

| | |
|---------------------|----------------|
| Circuit Application | Power & Signal |
|---------------------|----------------|

Industry Standards

| | |
|-----------------|--------------|
| Agency/Standard | CSA, UL, VDE |
|-----------------|--------------|

| | |
|------------------------|----------|
| UL Flammability Rating | UL 94V-0 |
|------------------------|----------|

Packaging Features

| | |
|--------------------|----|
| Packaging Quantity | 70 |
|--------------------|----|

| | |
|----------------|------|
| Packaging Type | Tray |
|----------------|------|

Product Compliance

[For compliance documentation, visit the product page on TE.com>](#)

| | |
|------------------------------|-----------|
| EU RoHS Directive 2011/65/EU | Compliant |
|------------------------------|-----------|

| | |
|-----------------------------|-----------|
| EU ELV Directive 2000/53/EC | Compliant |
|-----------------------------|-----------|

| | |
|---|---|
| China RoHS 2 Directive MIIT Order No 32, 2016 | No Restricted Materials Above Threshold |
|---|---|

| | |
|--|---|
| EU REACH Regulation (EC) No. 1907/2006 | Current ECHA Candidate List: JUNE 2023 (235) Candidate List Declared Against: JUNE 2023 (235) Does not contain REACH SVHC |
|--|---|

| | |
|-----------------|--|
| Halogen Content | Not Low Halogen - contains Br or Cl > 900 ppm. |
|-----------------|--|

| | |
|---------------------------|--|
| Solder Process Capability | Not reviewed for solder process capability |
|---------------------------|--|

Product Compliance Disclaimer

This information is provided based on reasonable inquiry of our suppliers and represents our current actual knowledge based on the information they provided. This information is subject to change. The part numbers that TE has identified as EU RoHS compliant have a maximum concentration of 0.1% by weight in homogenous materials for lead, hexavalent chromium, mercury, PBB, PBDE, DBP, BBP, DEHP, DIBP, and 0.01% for cadmium, or qualify for an exemption to these limits as defined in the Annexes of Directive 2011/65/EU (RoHS2). Finished electrical and electronic equipment products will be CE marked as required by Directive 2011/65/EU. Components may not be CE marked. Additionally, the part numbers that TE has identified as EU ELV compliant have a maximum concentration of 0.1% by weight in homogenous materials for lead, hexavalent chromium, and mercury, and 0.01% for cadmium, or qualify for an exemption to these limits as defined in the Annexes of Directive 2000/53/EC (ELV). Regarding the REACH Regulation, the information TE provides on SVHC in articles for this part number is based on the latest European Chemicals Agency (ECHA) 'Guidance on requirements for substances in articles' posted at this URL: <https://echa.europa.eu/guidance-documents/guidance-on-reach>

Compatible Parts



Also in the Series | AMP Metrimate

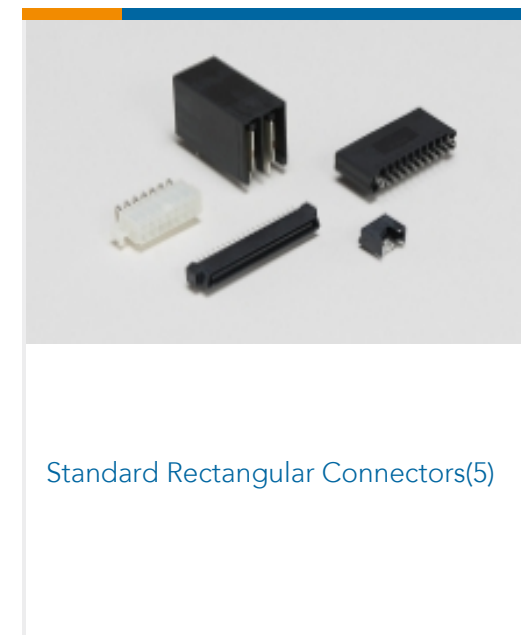
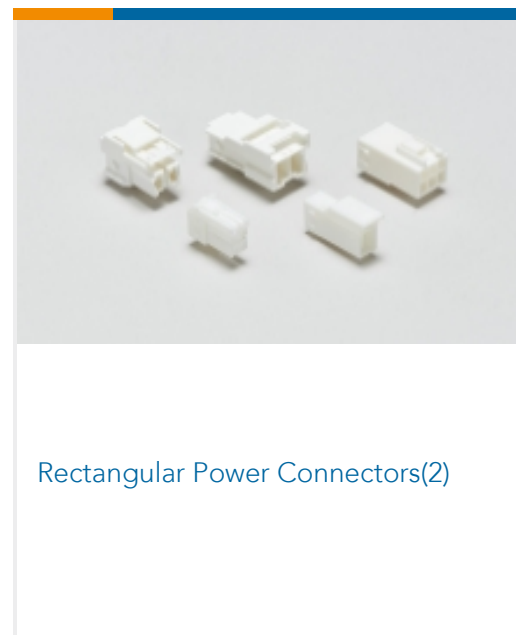
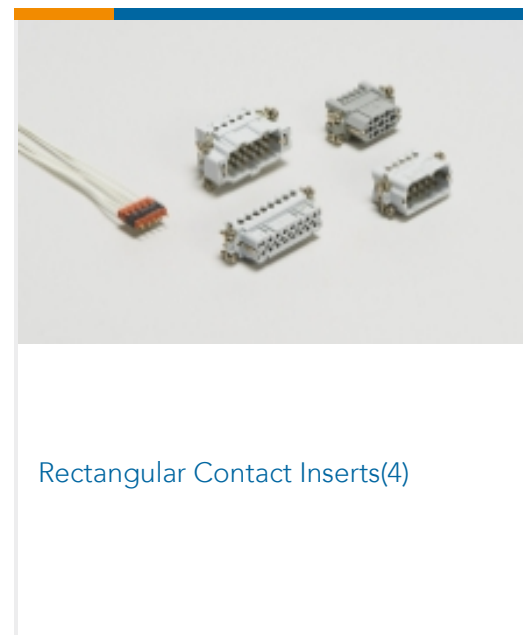
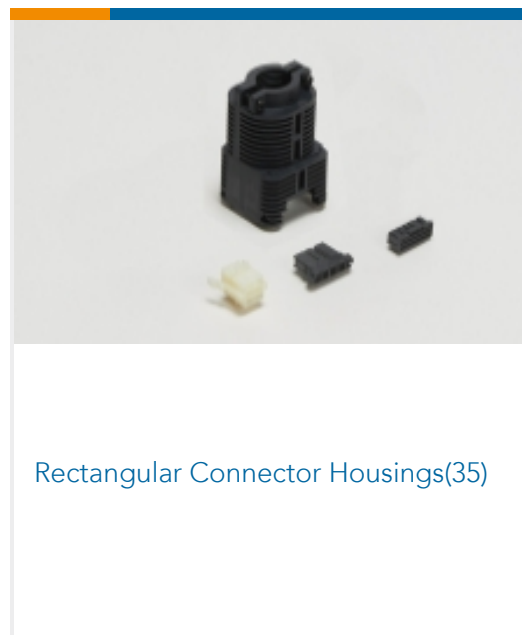
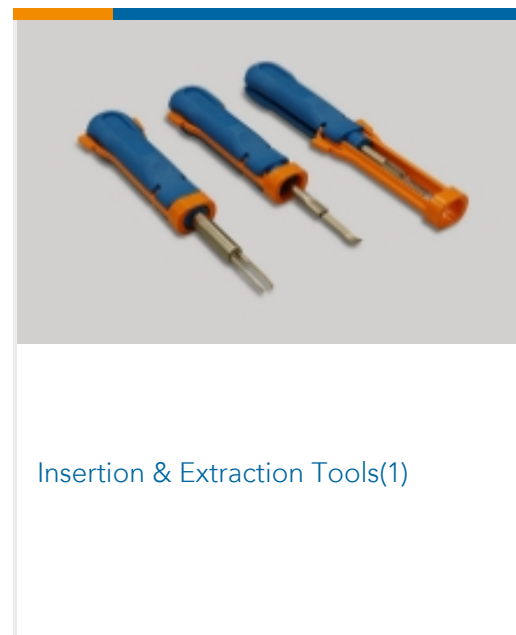
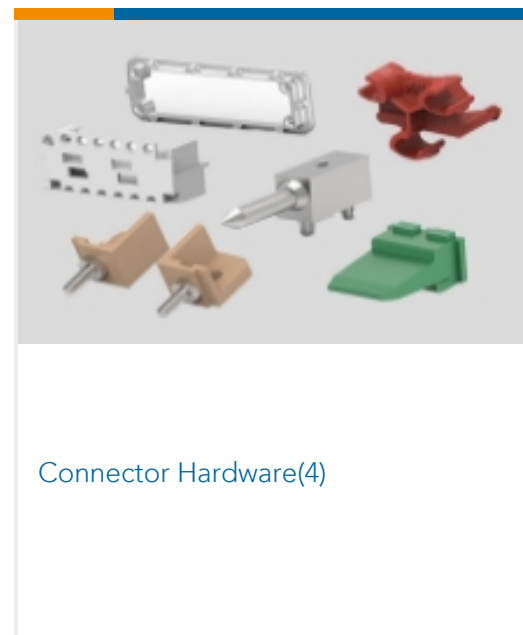
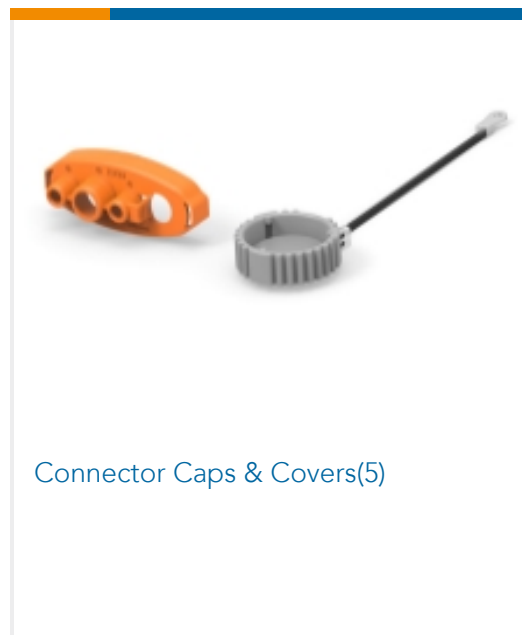

Customers Also Bought



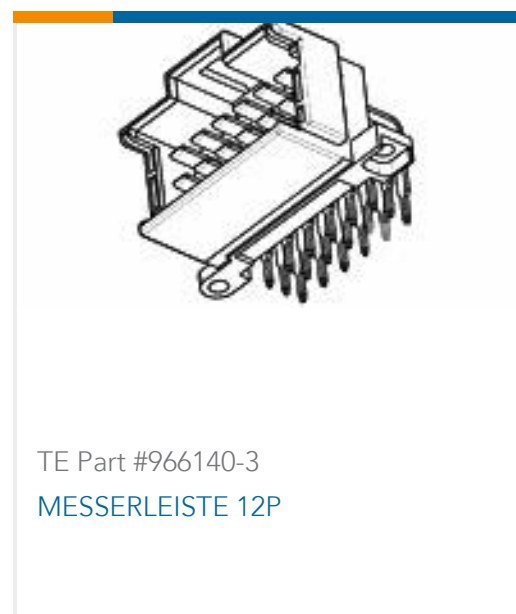

Documents

Product Drawings

METRIMATE PIN HEADER ASSY,9P

English

CAD Files

3D PDF

English

Customer View Model

[ENG_CVM_207441-7_M.2d_dxf.zip](#)

English

Customer View Model

[ENG_CVM_207441-7_M.3d_igs.zip](#)

English

Customer View Model

[ENG_CVM_207441-7_M.3d_stp.zip](#)

English

3D PDF

3D

Customer View Model

[ENG_CVM_CVM_207441-7_S.2d_dxf.zip](#)

English

Customer View Model

[ENG_CVM_CVM_207441-7_S.3d_igs.zip](#)

English

Customer View Model

[ENG_CVM_CVM_207441-7_S.3d_stp.zip](#)

English



By downloading the CAD file I accept and agree to the [Terms and Conditions](#) of use.

Datasheets & Catalog Pages

[METRIMATE_PIN_SOCKET_CATALOG](#)

English

Product Specifications

[Product Specification](#)

English

Product Environmental Compliance

[MD_207441-7_052920181157_dmtec](#)

English

[MD_207441-7_052920181157_dmtec](#)

English

Agency Approvals

[CSA Certificate](#)

English