

1971032-8 ✓ ACTIVE



GRACE INERTIA 2.0

TE Internal #: 1971032-8

PCB Mount Header, Vertical, Wire-to-Board, 8 Position, 2 mm [.079 in] Centerline, Fully Shrouded, Tin, Through Hole - Solder, GRACE INERTIA 2.0

[View on TE.com >](#)

Connectors > PCB Connectors > PCB Headers & Receptacles



Connector System: **Wire-to-Board**

Number of Positions: **8**

Number of Rows: **1**

Centerline (Pitch): **2 mm [.079 in]**

PCB Mount Orientation: **Vertical**

Features

Product Type Features

Connector System	Wire-to-Board
Header Type	Fully Shrouded
Sealable	No
Connector & Contact Terminates To	Printed Circuit Board
PCB Connector Assembly Type	PCB Mount Header

Configuration Features

Number of Positions	8
Number of Rows	1
PCB Mount Orientation	Vertical

Electrical Characteristics

Operating Voltage	50 VAC
-------------------	--------

Body Features

Primary Product Color	Natural
-----------------------	---------



Contact Features

Contact Mating Area Length	3 mm[.118 in]
Mating Square Post Dimension	.5 mm[.02 in]
PCB Contact Termination Area Plating Material Thickness	2 μ m[78.73 μ in]
Contact Layout	Inline
Contact Underplating Material Thickness	1 μ m[39.37 μ in]
Contact Mating Area Plating Material Thickness	2 μ m[78.73 μ in]
PCB Contact Termination Area Plating Material Finish	Bright
Contact Mating Area Plating Material Finish	Bright
Contact Underplating Material	Nickel
PCB Contact Termination Area Plating Material	Tin
Contact Base Material	Brass
Contact Mating Area Plating Material	Tin
Contact Type	Tab
Contact Current Rating (Max)	2.2 A

Termination Features

Square Termination Post & Tail Dimension	.5 mm[.02 in]
Termination Post & Tail Length	2.6 mm[.102 in]
Termination Method to Printed Circuit Board	Through Hole - Solder

Mechanical Attachment

PCB Mount Alignment Type	Locating Posts
Mating Alignment Type	Keyed
Mating Retention	With
Panel Mount Feature	Without
Mating Retention Type	Latch
Connector Mounting Type	Board Mount
Mating Alignment	With
PCB Mount Alignment	With
PCB Mount Retention	Without

Housing Features

Housing Material	Nylon 66 GF
Centerline (Pitch)	2 mm[.079 in]

Dimensions



Connector Length	20 mm[.78 in]
Connector Height	6.5 mm[.255 in]
Connector Width	5.6 mm[.22 in]
PCB Thickness (Recommended)	1.6 mm[.063 in]

Usage Conditions

Operating Temperature Range	-30 – 105 °C[-22 – 221 °F]
-----------------------------	----------------------------

Operation/Application

Circuit Application	Signal
---------------------	--------

Industry Standards

Agency/Standard	UL
UL Flammability Rating	UL 94V-0

Packaging Features

Packaging Quantity	200
Packaging Type	Package

Product Compliance

[For compliance documentation, visit the product page on TE.com>](#)

EU RoHS Directive 2011/65/EU	Compliant
EU ELV Directive 2000/53/EC	Compliant
China RoHS 2 Directive MIIT Order No 32, 2016	No Restricted Materials Above Threshold
EU REACH Regulation (EC) No. 1907/2006	Current ECHA Candidate List: JUNE 2023 (235) Candidate List Declared Against: JUNE 2023 (235) Does not contain REACH SVHC
Halogen Content	Not Low Halogen - contains Br or Cl > 900 ppm.
Solder Process Capability	Wave solder capable to 260°C

Product Compliance Disclaimer

This information is provided based on reasonable inquiry of our suppliers and represents our current actual knowledge based on the information they provided. This information is subject to change. The part numbers that TE has identified as EU RoHS compliant have a maximum concentration of 0.1% by weight in homogenous materials for lead, hexavalent chromium, mercury, PBB, PBDE, DBP, BBP, DEHP, DIBP, and 0.01% for cadmium, or qualify for an exemption to these limits as defined in the Annexes of Directive 2011/65/EU (RoHS2). Finished electrical and electronic equipment products will be CE marked as required by Directive 2011/65/EU. Components may not be CE marked. Additionally, the part numbers that TE has identified as EU ELV compliant have a maximum concentration of 0.1% by weight in homogenous materials for lead, hexavalent chromium, and mercury, and 0.01% for cadmium, or qualify for an exemption to these limits

as defined in the Annexes of Directive 2000/53/EC (ELV). Regarding the REACH Regulation, the information TE provides on SVHC in articles for this part number is based on the latest European Chemicals Agency (ECHA) 'Guidance on requirements for substances in articles' posted at this URL: <https://echa.europa.eu/guidance-documents/guidance-on-reach>

Compatible Parts



TE Part # 1971032-9
9POS HEADER ASSEMBLY FOR GIC 2.0 EV



TE Part # 1971032-1
10POS HEADER ASSEMBLY FOR GIC 2.0 EV



TE Part # 1971032-4
4POS HEADER ASSEMBLY FOR GIC 2.0 EV



TE Part # 1971032-3
3P HEADER ASSEMBLY FOR GIC 2.0 EV



TE Part # 1971032-5
5P HEADER ASSEMBLY FOR GIC 2.0 EV



TE Part # 1971032-7
7pos header assembly for gic 2.0 ev



TE Part # 1971032-2
2POS HEADER ASSEMBLY FOR GIC 2.0 EV



TE Part # 1971032-6
6POS HEADER ASSEMBLY FOR GIC 2.0 EV



TE Part # 1-1971032-3
3POS HEADER ASSEMBLY FOR GIC 2.0 EV



TE Part # 1-1971032-8
8POS HEADER ASSEMBLY FOR GIC 2.0 EV



TE Part # 2-1971032-8
8POS HEADER ASSEMBLY FOR GIC 2.0 EV



TE Part # 3-1971032-8
8POS HEADER ASSEMBLY FOR GIC 2.0 EV

Also in the Series | GRACE INERTIA 2.0



Connector Contacts(3)



PCB Headers & Receptacles(70)



Rectangular Connector Housings(20)



Standard Rectangular Connectors(18)



Wire-to-Board Connector Assemblies & Housings(1)

Customers Also Bought

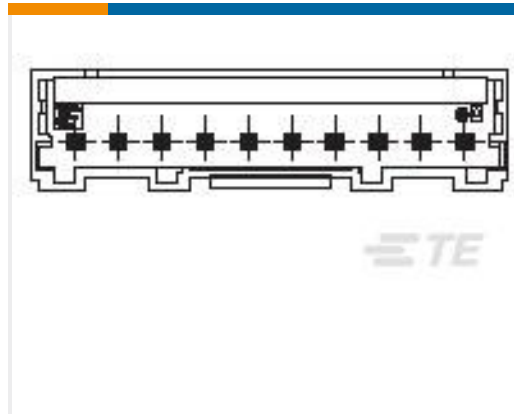
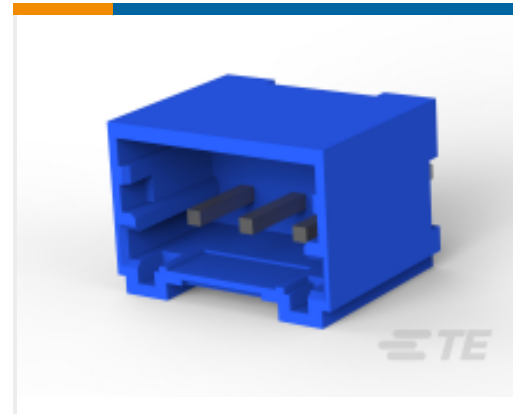
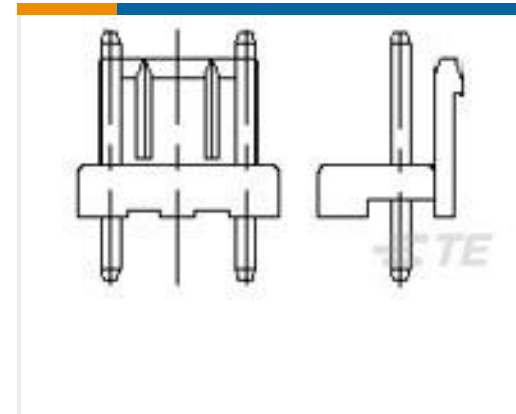
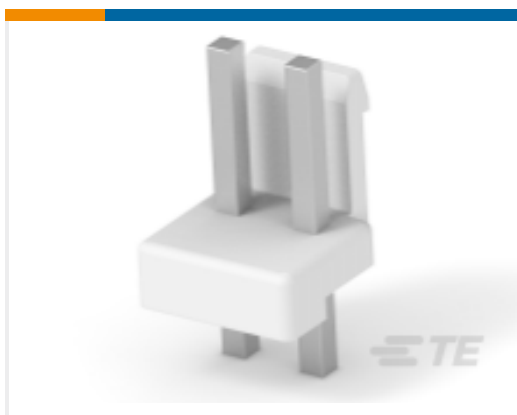
TE Part #1-292173-4
CT BOX HDR H SMT 4P O/TAPE NATTE Part #1971032-9
9POS HEADER ASSEMBLY FOR GIC 2.0 EVTE Part #2-1971032-3
3POS HEADER ASSEMBLY FOR GIC 2.0 EVTE Part #1744103-1
3.96 EPHDR ASSY 3P OMIT #2 PINTE Part #1744103-2
3.96 EPHDR ASSY 2PTE Part #2367943-5
G12.0EV VT SMT Poting HDR,NTL,Key A,5PTE Part #5-1744105-4
EP HDR ASSY 5P omit 2&4,black A,5P

Documents

Product Drawings

[8POS HEADER ASSEMBLY FOR GIC 2.0 EV](#)

English

[8POS HEADER ASSEMBLY FOR GIC 2.0 EV](#)

English

CAD Files

[3D PDF](#)

3D

Customer View Model

[ENG_CVM_CVM_1971032-8_D.2d_dxf.zip](#)

English

Customer View Model

[ENG_CVM_CVM_1971032-8_D.3d_igs.zip](#)

English

Customer View Model

[ENG_CVM_CVM_1971032-8_D.3d_stp.zip](#)



English

By downloading the CAD file I accept and agree to the [Terms and Conditions](#) of use.

Product Specifications

[Application Specification](#)

English

Product Environmental Compliance

[MD_1971032-8_082020181216_dmtec](#)

English

[MD_1971032-8_082020181216_dmtec](#)

English