

FEATURES

- Fast switching
- 100% avalanche tested
- Improved dv/dt capability

APPLICATIONS

- Switch Mode Power Supply (SMPS)
- Uninterruptible Power Supply (UPS)
- Power Factor Correction (PFC)

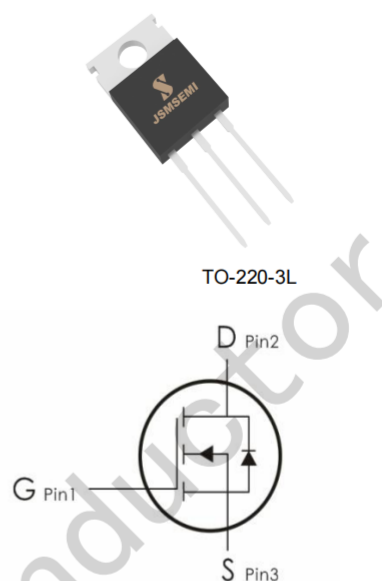

Device Marking and Package Information		
Device	Package	Marking
IRFB7537PBF	TO-220	IRFB7537

Absolute Maximum Ratings $T_C = 25^\circ\text{C}$, unless otherwise noted			
Parameter	Symbol	Value	Unit
		TO-220	
Drain-Source Voltage ($V_{GS} = 0\text{V}$)	V_{DSS}	60	V
Continuous Drain Current	I_D	180	A
Pulsed Drain Current (note1)	I_{DM}	720	A
Gate-Source Voltage	V_{GSS}	± 20	V
Single Pulse Avalanche Energy (note2)	E_{AS}	653	mJ
Avalanche Current (note1)	I_{AS}	40	A
Repetitive Avalanche Energy (note1)	E_{AR}	391.8	mJ
Power Dissipation ($T_C = 25^\circ\text{C}$)	P_D	358	W
Operating Junction and Storage Temperature Range	T_J, T_{stg}	-55~+150	$^\circ\text{C}$

Thermal Resistance			
Parameter	Symbol	Value	Unit
Thermal Resistance, Junction-to-Case	R_{thJC}	0.65	$^\circ\text{C/W}$
Thermal Resistance, Junction-to-Ambient	R_{thJA}	62	

Specifications $T_J = 25^\circ\text{C}$, unless otherwise noted

Parameter	Symbol	Test Conditions	Value			Unit
			Min.	Typ.	Max.	
Static						
Drain-Source Breakdown Voltage	$V_{(BR)DSS}$	$V_{GS} = 0V, I_D = 250\mu A$	60	--	--	V
Zero Gate Voltage Drain Current	I_{DSS}	$V_{DS} = 60V, V_{GS} = 0V, T_J = 25^\circ\text{C}$	--	--	1	μA
Gate-Source Leakage	I_{GSS}	$V_{GS} = \pm 20V, V_{DS} = 0V$	--	--	± 100	nA
Gate-Source Threshold Voltage	$V_{GS(th)}$	$V_{DS} = V_{GS}, I_D = 250\mu A$	2.0	--	4.0	V
Drain-Source On-Resistance (Note3)	$R_{DS(on)}$	$V_{GS} = 10V, I_D = 60A$	--	0.003	0.005	Ω
Forward Transconductance	gfs	$V_{DS} = 25V, I_D = 60A$	--	17	--	S
Dynamic						
Input Capacitance	C_{iss}	$V_{GS} = 0V,$ $V_{DS} = 25V,$ $f = 1.0\text{MHz}$	--	3699	--	pF
Output Capacitance	C_{oss}		--	1316	--	
Reverse Transfer Capacitance	C_{rss}		--	687	--	
Total Gate Charge	Q_g	$V_{DS} = 28V, V_{GS} = 15V,$ $I_D = 42A$	--	115	--	nC
Gate-Source Charge	Q_{gs}		--	13	--	
Gate-Drain Charge	Q_{gd}		--	55	--	
Turn-on Delay Time	$t_{d(on)}$	$V_{DD} = 28V, I_D = 42A,$ $V_{GS} = 15V, R_G = 25\Omega$	--	52	--	ns
Turn-on Rise Time	t_r		--	142	--	
Turn-off Delay Time	$t_{d(off)}$		--	355	--	
Turn-off Fall Time	t_f		--	230	--	
Drain-Source Body Diode Characteristics						
Continuous Source Current	I_{SD}	$T_J = 25^\circ\text{C}, I_{SD} = 60A, V_{GS} = 0V$	--	--	180	A
Pulsed Source Current	I_{SM}		--	--	720	
Body Forward Voltage	V_{SD}	$I_S = 40A, V_{GS} = 0V$	--	--	1.2	V
Reverse Recovery Time	t_{rr}	$V_{GS} = 0V, I_F = 180A,$ $di_F/dt = 100A/\mu s$	--	100	--	ns
Reverse Recovery Charge	Q_{rr}		--	0.33	--	μC

Notes

1. Repetitive Rating: Pulse width limited by maximum junction temperature
2. $L = 1\text{mH}, V_{DD} = 50V, R_G = 25\Omega, \text{Starting } T_J = 25^\circ\text{C}$
3. Pulse Test: Pulse width $\leq 300\mu s, \text{Duty Cycle } \leq 1\%$

Typical Characteristics $T_J = 25^\circ\text{C}$, unless otherwise noted

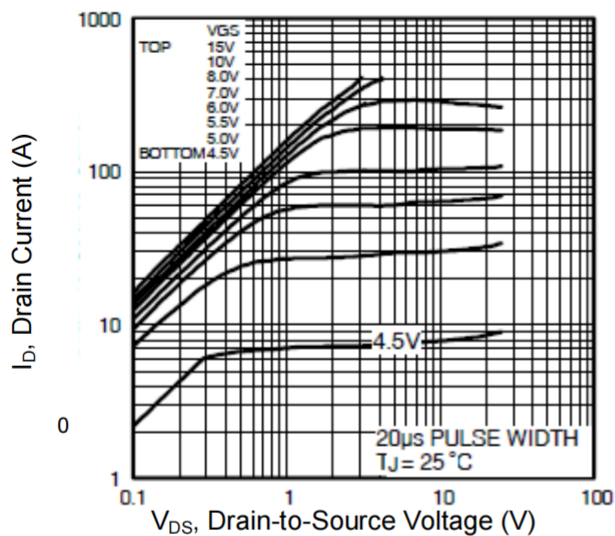
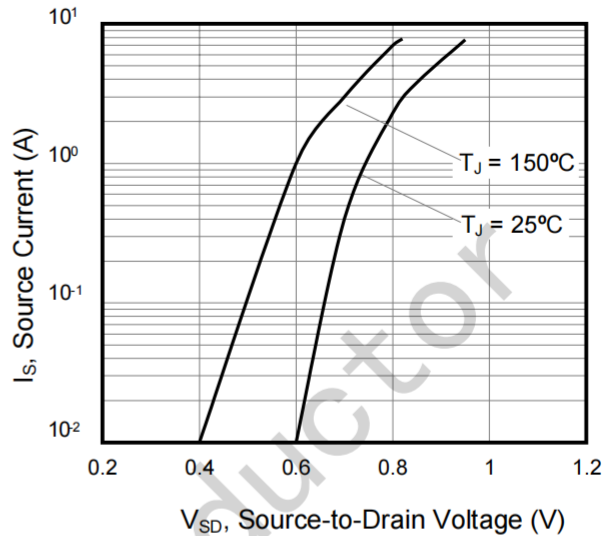
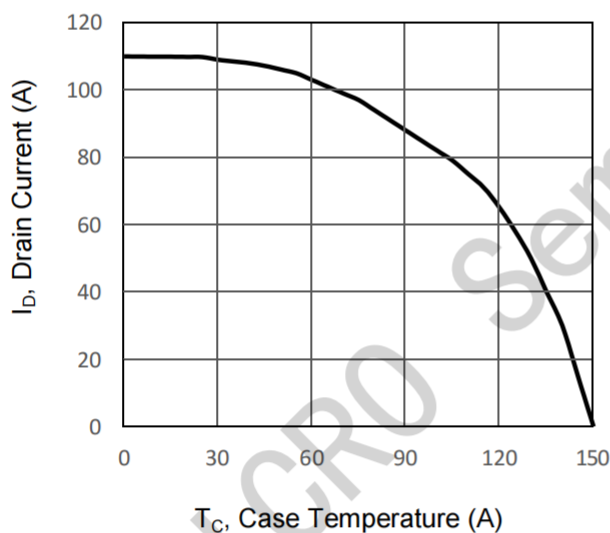
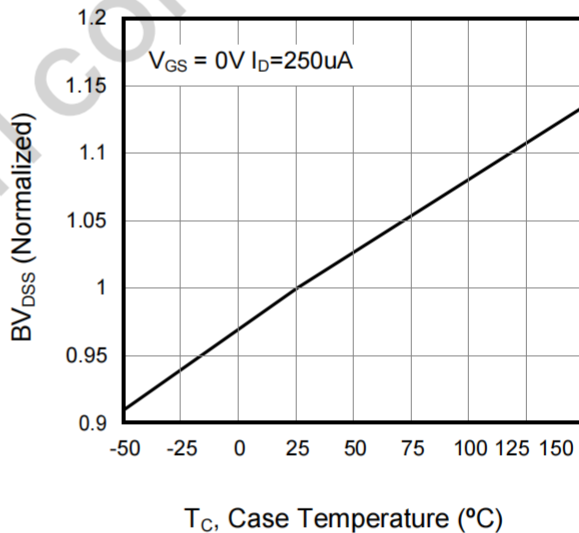
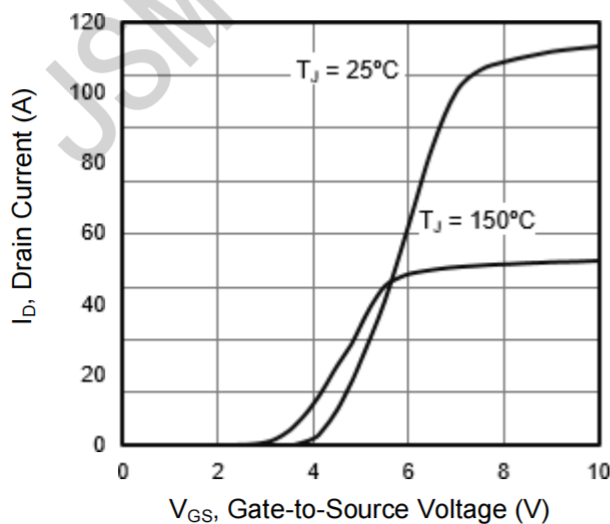
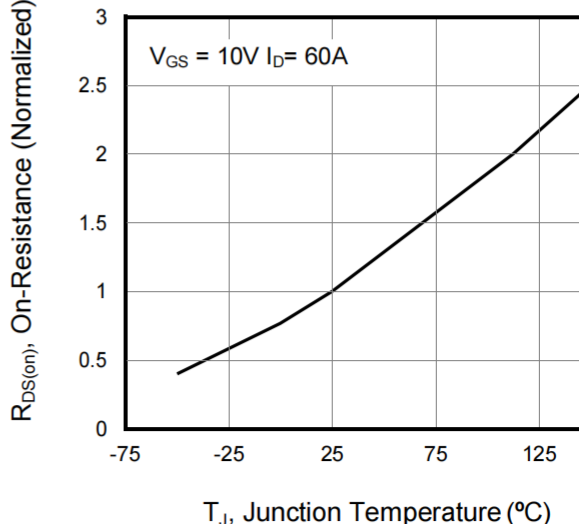
Figure 1. Output Characteristics ($T_J = 25^\circ\text{C}$)

Figure 2. Body Diode Forward Voltage

Figure 3. Drain Current vs. Temperature

Figure 4. BV_{DSS} Variation vs. Temperature

Figure 5. Transfer Characteristics

Figure 6. On-Resistance vs. Temperature

Typical Characteristics $T_J = 25^\circ\text{C}$, unless otherwise noted

Figure 7. Capacitance

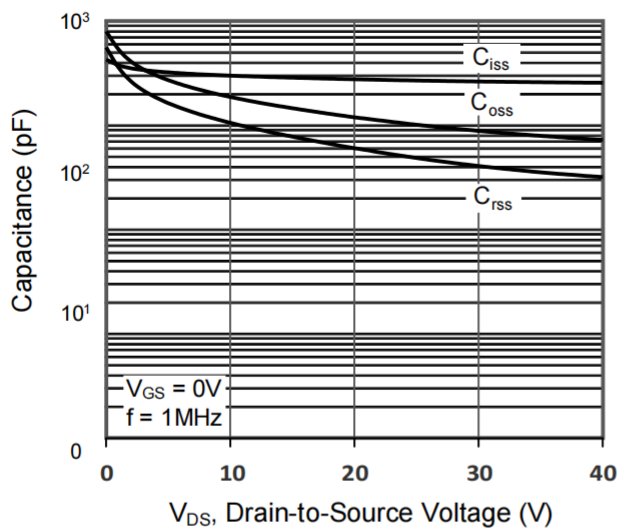

Figure 8. Gate Charge

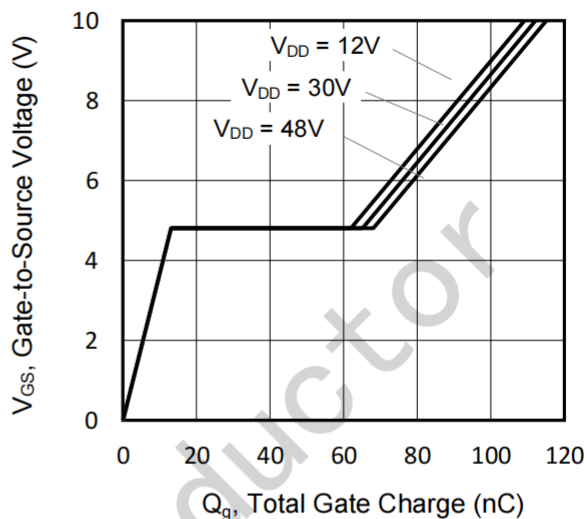

Figure 9. Transient Thermal Impedance
TO-220

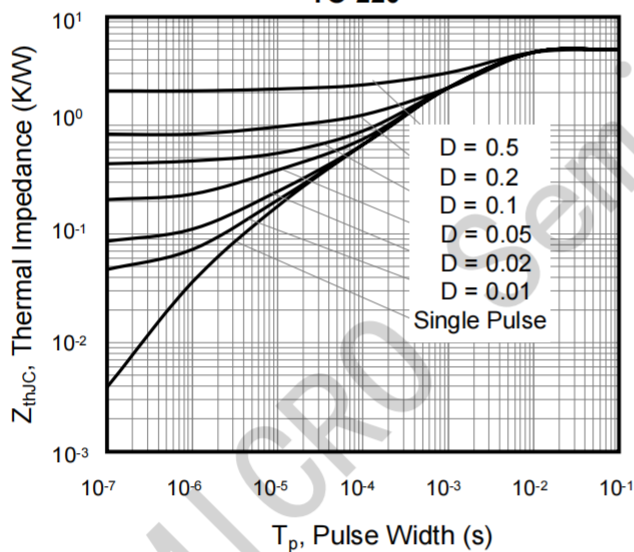

Figure A: Gate Charge Test Circuit and Waveform

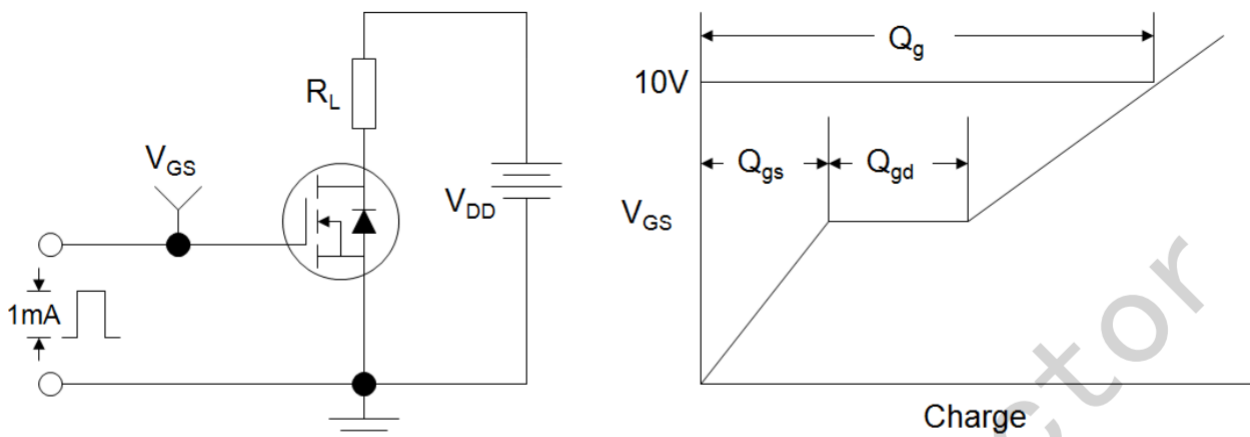

Figure B: Resistive Switching Test Circuit and Waveform

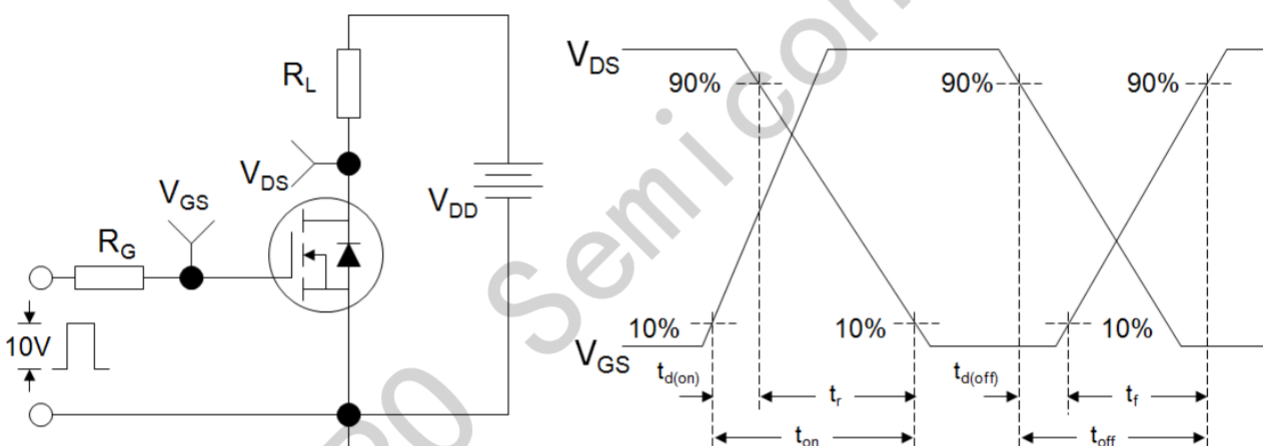
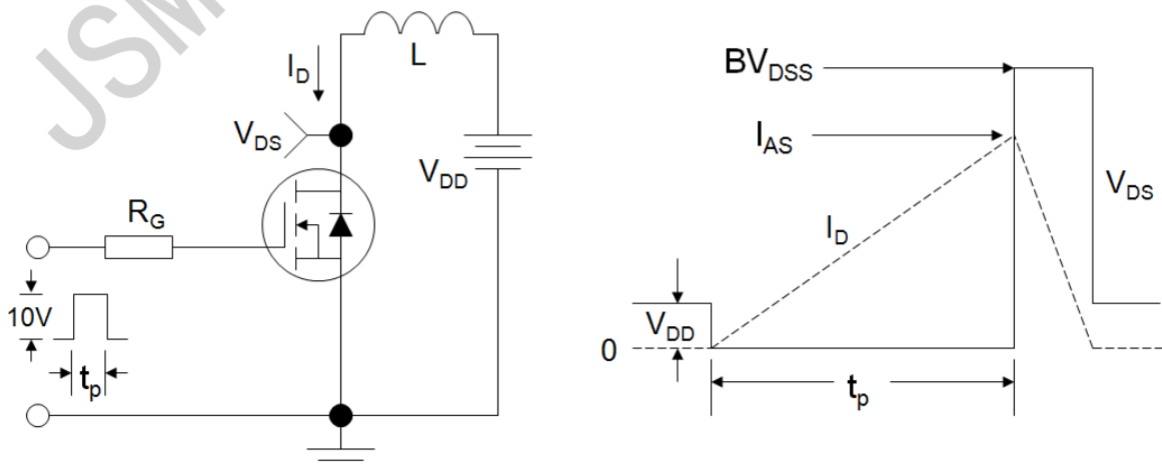
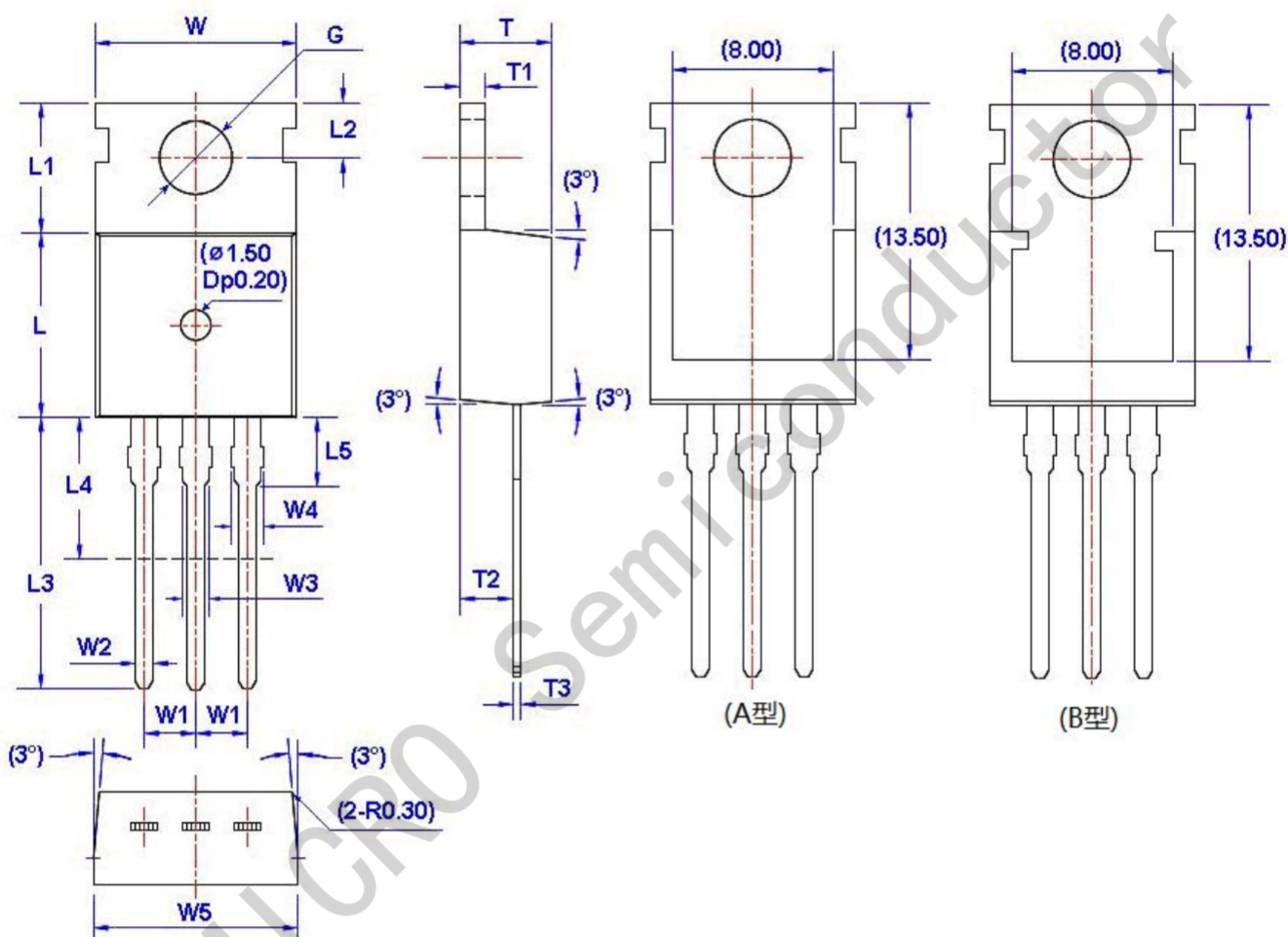

Figure C: Unclamped Inductive Switching Test Circuit and Waveform



Package Information

TO-220



Unit: mm

Symbol	Size		Symbol	Size		Symbol	Size		Symbol	Size	
	Min	Max		Min	Max		Min	Max		Min	Max
W	9.66	10.28	W5	9.80	10.20	L4**	6.20	6.60	T3	0.45	0.60
W1	2.54 (TYP)		L	9.00	9.40	L5	2.79	3.30	G(Φ)	3.50	3.70
W2	0.70	0.95	L1	6.40	6.80	T	4.30	4.70			
W3	1.17	1.37	L2	2.70	2.90	T1	1.15	1.40			
W4*	1.32	1.72	L3	12.70	14.27	T2	2.20	2.60			