

Features

- Low dynamic output impedance.
- Sink current capability of 1.0 to 100mA.
- Low output noise voltage
- Fast turn on response

Application

- It provides very wide applications, including shunt regulator, series regulator, switching regulator, voltage reference and others.

SOT-23

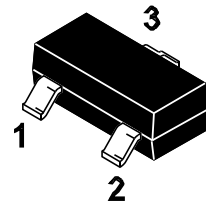

1. Cathode 2.Reference 3.Anode

Marking Code:

CD431: 431

CD431A: 431A

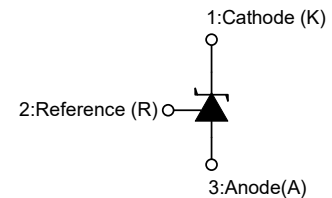

Absolute Maximum Ratings (Ta=25°C unless otherwise specified)

Parameter	Symbol	Value	Units
Cathode Voltage	V_{KA}	37	V
Cathode Current Range(Continuous)	I_{KA}	-100 ~ +150	mA
Reference Input Current Range	I_{REF}	-0.05 ~ +10	mA
Maximum Power Dissipation	P_D	350	mW
Operating Junction Temperature	T_J	150	°C
Storage Temperature Range	T_{STG}	-65 ~ +150	°C

Recommended Operating Conditions

Parameter	Symbol	Min.	Max.	Units
Cathode Voltage	V_{KA}	V_{REF}	36	V
Cathode Current	I_{KA}	1	100	mA
Operating Ambient Temperature Range	T_{OPR}	-25	85	°C

Electrical Characteristics (Ta=25°C unless otherwise specified)

Parameter	Symbol	Test Conditions	Min.	Typ.	Max.	Unit	
Reference Input Voltage Fig ¹	V _{REF}	V _{KA} =V _{REF} , I _{KA} =10mA	CD431(1%)	2.47	2.495	2.52	V
			CD431A(0.5%)	2.483	2.495	2.507	V
Deviation of Reference Input Voltage Over Temperature Fig ¹	ΔV _{REF}	V _{KA} =V _{REF} , I _{KA} =10mA -25°C ≤ T _A ≤ +85°C	--	4.5	17	mV	
Ratio of Change in Reference Input Voltage to The Change in Cathode Voltage Fig ²	$\frac{\Delta V_{REF}}{\Delta V_{KA}}$	I _{KA} =10mA	ΔV _{KA} =10V~V _{REF}	--	-1.0	-2.7	mV/V
			ΔV _{KA} =36V~10V	--	-0.5	-2.0	
Reference Input Current Fig ²	I _{REF}	I _{KA} =10mA, R1=10KΩ, R2=∞	--	1.5	4	μA	
Deviation of Reference Input Current Over Full Temperature Range Fig ²	ΔI _{REF}	I _{KA} =10mA, R1=10KΩ, R2=∞, -25°C ≤ T _A ≤ +85°C	--	0.4	1.2	μA	
Minimum Cathode Current for Regulation Fig ¹	I _{KA(MIN)}	V _{KA} =V _{REF}	--	0.45	1	mA	
Off-State Cathode Current Fig ³	I _{KA(OFF)}	V _{KA} =36V, V _{REF} =0	--	0.05	1.0	μA	
Dynamic Impedance	Z _{KA}	V _{KA} =V _{REF} , I _{KA} =1~100mA, f≤1.0KHZ	--	0.15	0.5	Ω	

Figure 1. Test Circuit for V_{KA} = V_{REF}

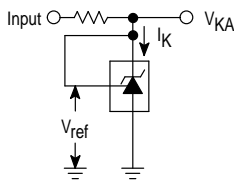

Figure 2. Test Circuit for V_{KA} > V_{REF}

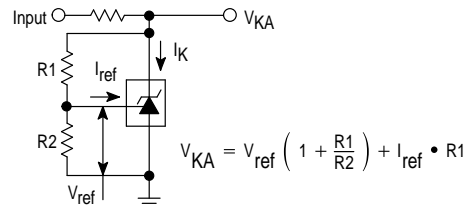
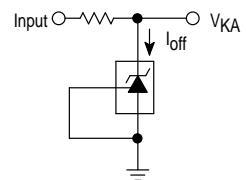
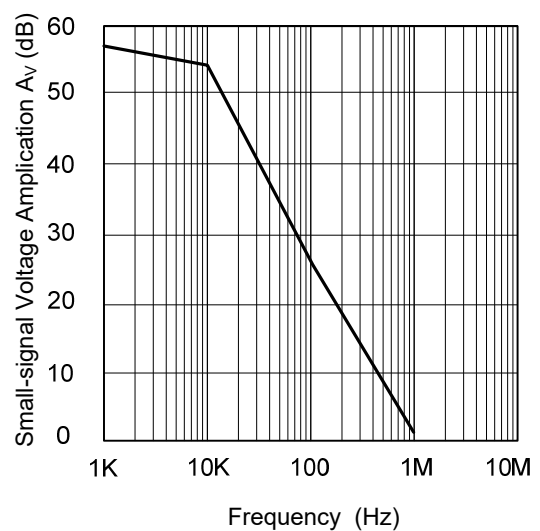
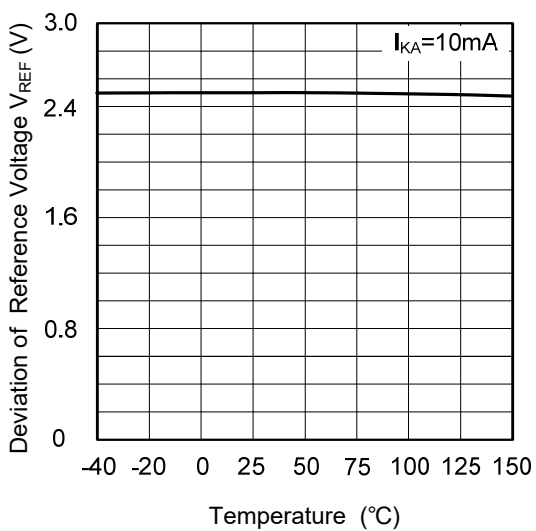
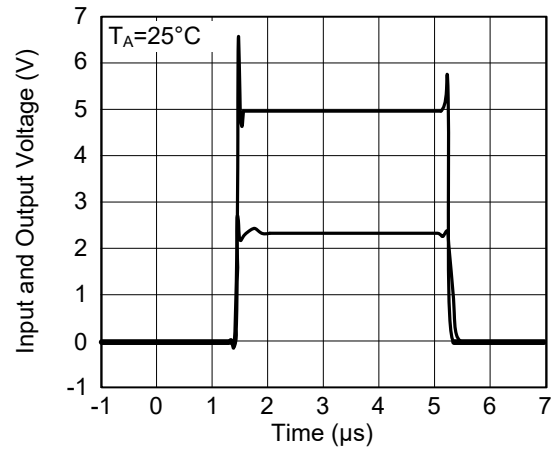
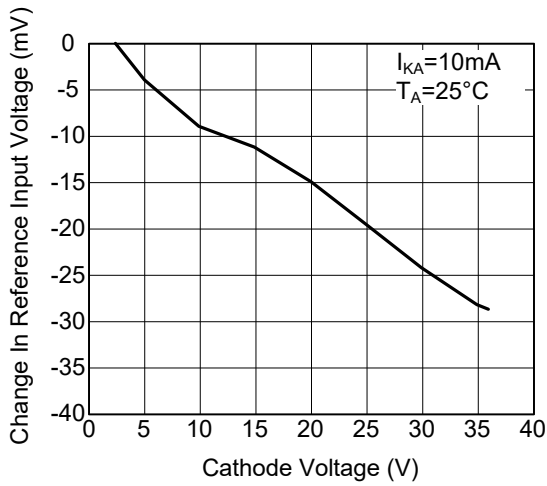
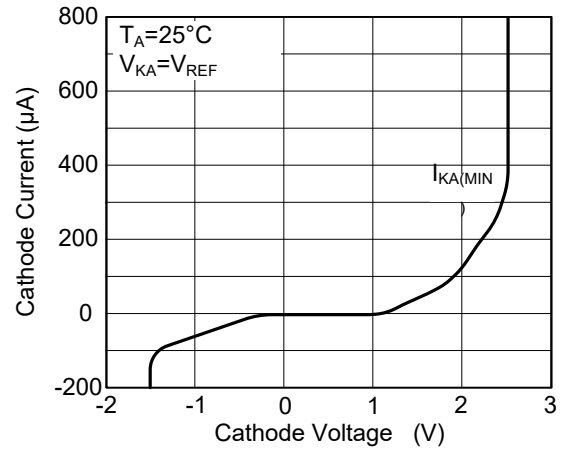
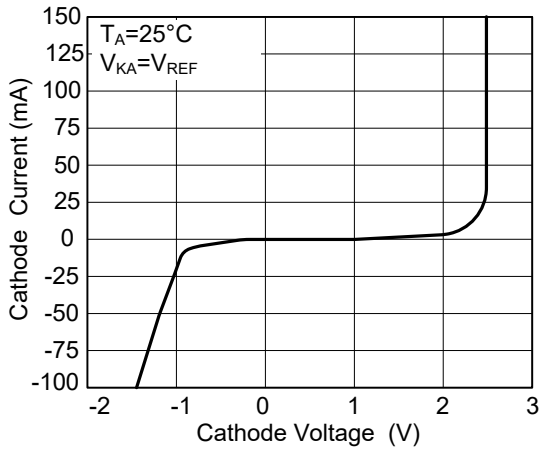

Figure 3. Test Circuit for I_{OFF}





Typical Characteristic Curves





Package Outline

SOT-23

Dimensions in mm

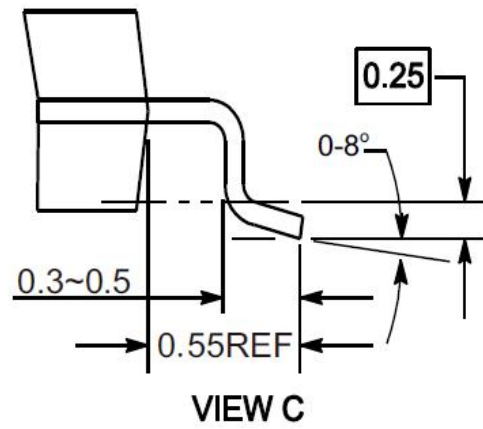
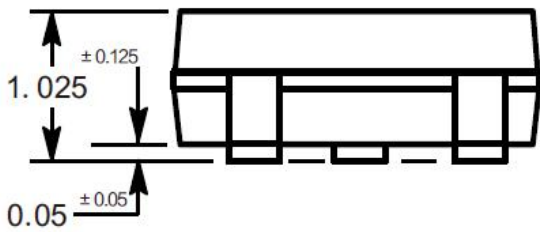
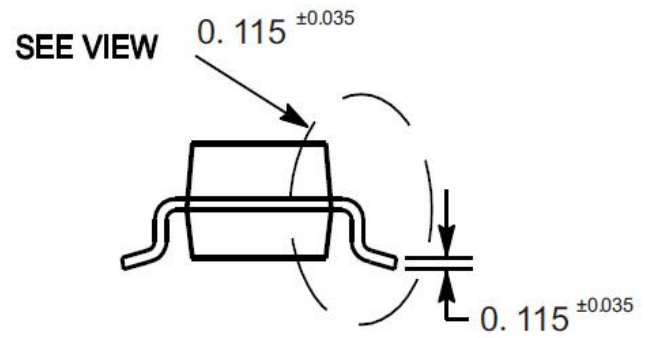
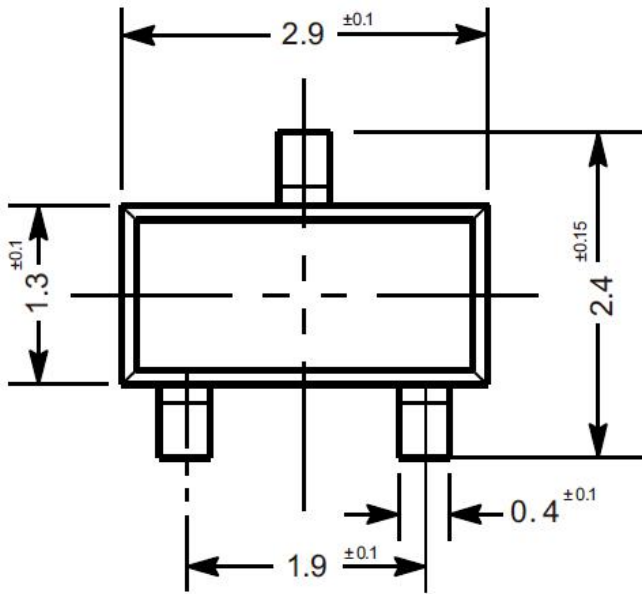

Ordering Information

Device	Package	Shipping
CD431/CD431A	SOT-23	3,000PCS/Reel&7inches