

KL851

HIGH VOLTAGE PHOTO TRANSISTOR

DIP4 高压晶体管光耦

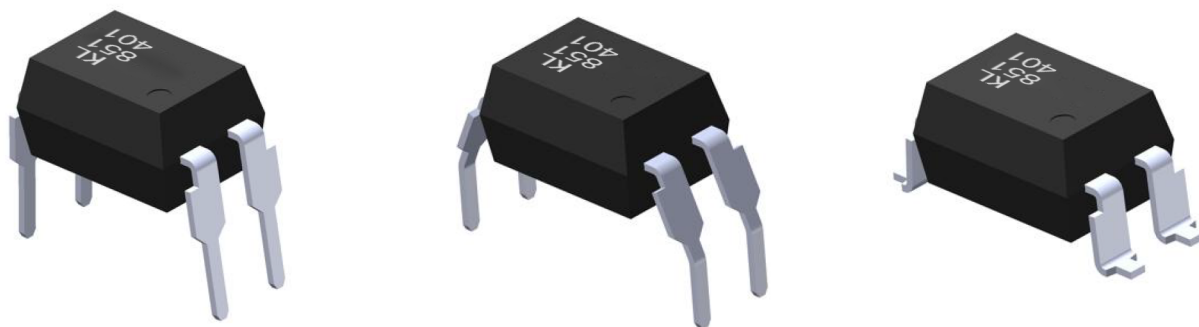

* 本文中包含的信息反映了具有代表性的使用场景，仅供技术参考。

The information contained in this document reflects representative usage scenarios and is intended for technical reference only.

* 本文中提到的产品型号和规格如有更改或改进，恕不另行通知。在生产使用之前，客户应参考产品规格书的最新数据表。

Product models and specifications mentioned in this document are subject to change or improvement without notice. Customers should refer to the latest data sheets in the product specifications prior to production use.

* 在使用本文中引用的产品时，请确保产品在数据手册中规定的环境和电气限制范围内运行。如果客户使用超过指定的限制，晶台将不会对任何后续问题负责。

When using the products referenced in this document, ensure that the products are operated within the environmental and electrical limits specified in the data sheet. If the customer uses the product beyond the specified limits, Kinglight will not be responsible for any subsequent problems.

* 本文档中的信息适用于电子元器件应用中的典型用法。如有任何特殊用途，请向晶台咨询，以获得进一步的帮助。

The information in this document applies to typical use in electronic component applications. For special applications, please contact Kinglight for further assistance.

* 未经晶台允许，不得复制或转载本文件的内容和信息。对于最新的信息，请参考官方网站 www.kinglight.com。

The contents and information in this document may not be copied or reproduced without the permission of Kinglight. For the latest information, please visit the official website www.kinglight.com.

1. 产品特点 Product features

- 电流转换率(Current transfer ratio)
(CTR: 50~600% at $I_F = 5\text{mA}$, $V_{CE} = 5\text{V}$)
- 集电极-发射极高电压(V_{CE} Min350V)
High collector- emitter voltage (V_{CE} Min350V)
- 输入与输出高隔离电压($V_{iso}=5000\text{ V rms}$)
High isolation voltage between inputs and output ($V_{iso}=5000\text{ V rms}$)
- 紧凑的双列式封装 Compact dual-in-line package
- 产品本身将保持在符合RoHS的版本范围内
The product itself will remain within RoHS compliant version
- 符合欧盟REACH法规 Compliance with EU REACH
- 合规无卤素 (仅限铜引线框) (溴<900ppm, 氯<900ppm, 溴+氯<1500ppm)
Compliance Halogens Free (Only copper leadframe) (Br < 900ppm, Cl < 900ppm, Br+Cl < 1500ppm)
- CQC认证已批准(编号:CQC23001407997)
CQC approved (No. CQC23001407997)

2. 产品描述 Product Description

- KL851由红外发射二极管与光电晶体管耦合, 组成光电耦合器。
The KL851 series devices consist an infrared emitting diodes, optically coupled to a phototransistor detector.
- 此器件采用4引脚DIP封装, 提供宽引脚间距和SMD选项
The devices are in a 4-pin DIP package and available in wide-lead spacing and SMD option.

3. 产品应用 Product Applications

- 电话线接口Telephone line interface
- 与电源电路的接口 Interface to power supply circuit
- SSRs的控制器, 直流电动机 Controller for SSRs. DC motor
- 可编程序控制器 Programmable Controllers

4. 示意图 Schematic

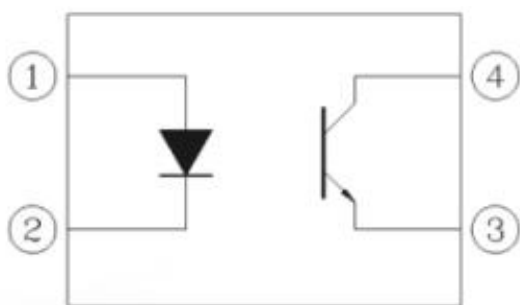

引脚配置 Pin Configuration

1. 阳极Anode
2. 阴极Cathode
3. 发射极Emitter
4. 集电极Collector

5. 光电特性 Electrical-Optical characteristics

• 最大限度额定值(温度=25°C) Absolute Maximum Ratings(Ta=25°C)

参数 Parameter		符号 Symbol	额定值 Rated Value	单位 Unit
输入 Input	正向电流 Forward current	I_F	60	mA
	峰值正向电流 (1μs脉冲) Peak forward current (1μs pulse)	I_{FM}	1	A
	反向电压 Reverse voltage	V_R	6	V
	功耗 Power dissipation	P_D	100	mW
输出 Output	集电极功耗 Collector power dissipation	P_C	150	mW
	集电极发射极电压 Collector-Emitter voltage	V_{CEO}	350	V
	集电极电流 Collector current	I_C	50	mA
	发射极-集电极电压 Emitter-Collector voltage	V_{ECO}	7	V
总消耗功率 Total Power Dissipation		P_{TOT}	200	mW
隔离电压 (1*) Isolation Voltage		V_{ISO}	5000	Vrms
工作温度 Operating temperature		T_{OPR}	-55 to +100	°C
储存温度 Storage temperature		T_{STG}	-55 to +125	°C
焊接温度 (2*) Soldering temperature		T_{SOL}	260	°C

附注(Notes):

1* 交流电源1分钟内, 相对湿度=40~60%R.H.在此测试中, 引脚1&2短接在一起, 引脚3&4短接在一起。
AC for 1 minute, R.H.= 40 ~ 60% R.H. In this test, pins 1&2 are shorted together, and pins 3& 4 are shorted together.

2* 焊接时间为10秒 Soldering time is 10 seconds

6. 电气特性(Ta=25°C,除非另有规定)

Electrical Characteristics(Ta=25°C unless specified otherwise)

参数 Parameter		符号 Symbol	最小值 Min.	规格值 Typ.	最大值 Max.	单位 Unit	条件 Condition
输入 In put	正向电压 Forward voltage	V_F	-	1.2	1.4	V	$I_F=10\text{mA}$
	反向电流 Reverse current	I_R	-	-	10	μA	$V_R=5\text{V}$
	输入电容 Input capacitance	C_{in}	-	30	250	pF	$V=0, f=1\text{kHz}$
输出 Out put	集电极与发射极间暗电流 Collector-Emitter dark current	I_{CEO}	-	-	100	nA	$V_{CE}=200\text{V}$ $I_F=0\text{mA}$
	集电极与发射极间击穿电压 Collector-Emitter breakdown voltage	V_{CEO}	350	-	-	V	$I_C=0.1\text{mA}$ $I_F=0\text{mA}$
	发射极与集电极间击穿电压 Emitter-Collector breakdown voltage	V_{ECO}	7	-	-	V	$I_E=0.1\text{mA}$ $I_F=0\text{mA}$
	集电极电容 Collector-Emitter capacitance	C_{CE}	-	10	-	pF	$V_{CE}=0\text{V}$ $f=1\text{MHz}$
传输特性 Transfer Characteristics	集电极与发射极间饱和电压 Collector-Emitter saturation voltage	$V_{CE(sat)}$	-	-	0.4	V	$I_F=20\text{mA}$ $I_C=1\text{mA}$
	电流传输比 Current transfer ratio(1*)	CTR	50	-	600	%	$I_F=5\text{mA}$ $V_{CE}=5\text{V}$
	隔离电阻 Isolation resistance	R_{IO}	10^{11}	-	-	Ω	$V_{IO}=500\text{Vdc}$ 40~60% R.H.
	输入输出电容 Input-output capacitance	C_{IO}	-	0.6	-	pF	$V_{IO}=0, f=1\text{MHz}$
	上升时间 Rise time	t_r	-	4	18	μs	$V_{CE}=2\text{V}$, $I_C=2\text{mA}$, $R_L=100\Omega$
	下降时间 Fall time	t_f	-	5	18	μs	

• 温度Ta=25°C下规格值 Typical values at Ta = 25°C

7. 可靠性试验 Reliability Test

序号 NO.	试验项目 Test Items	参考标准 Reference	试验条件 Test conditions	试验过程 Test process	试验数 Qty.(pcs)	允收水准 LTPD
1	温度循环 TC	JESD22-A104C	H:125±5°C 15min ∫5min L:-55±5°C 15min	300cycle	45	0/45
2	高温操作寿命 HTOL	JESD22-A108C	HTOL@100°±5C IF=10mA Ic=20mA	168、500、 1000hrs	45	0/45
3	高温反向偏压 HTRB	JESD22-A108C	HTRB@100±5°C Vce=280V	168、500、 1000hrs	45	0/45
4	温湿度反向偏 压寿命试验 H3TRB	JESD22-A101- B	H3TRB@ 85+5/- 2°C、85±5%RH Vce=60V	168、500、 1000hrs	45	0/45
5	压力锅 Autoclave	JESD22-A102- C	Ta=121±5°C, 100±5%RH, 2atm	96hrs	45	0/45
6	高温储存 HTS	JESD22-A103C	HTS@125±5°C	168、500、 1000hrs	45	0/45
7	低温储存 LTS	JESD22-A119	LTS@-55±5°C	168、500、 1000hrs	45	0/45
8	耐锡热试验 RSH	JESD22-B106C	RSH@260±5°C	10sec*3times	45	0/45
9	可焊性 SD	JESD22-B102D	Pb-free@ 245±5°C	3sec*1times	22	0/22
备注 Remarks	<p>以上试验项目如与客户试验要求存在差异或者特殊客户特殊要求的,可根据实际情况按照客户的要求进行试 作,客户未要求依我司试验标准试作,不同产品使用不同电流进行测试</p> <p>All the tests should be performed according to customers' actual requirements, while difference of test standard or special requirements exist. Otherwise, all the tests are performed according to the standard listed above. Different current is applied to the tests of different product models</p>					

8. 特性曲线 Characteristic Curves

图1 正向电流与正向电压的关系

Fig.1 Forward Current vs Forward Voltage



图3 集电极电流与集电极发射极电压的关系

Fig.3 Collector Current vs Collector Emitter Voltage



图5.集电极-发射极饱和电压与环境温度的关系
Fig.5 Collector-emitter Saturation Voltage vs Ambient Temperature

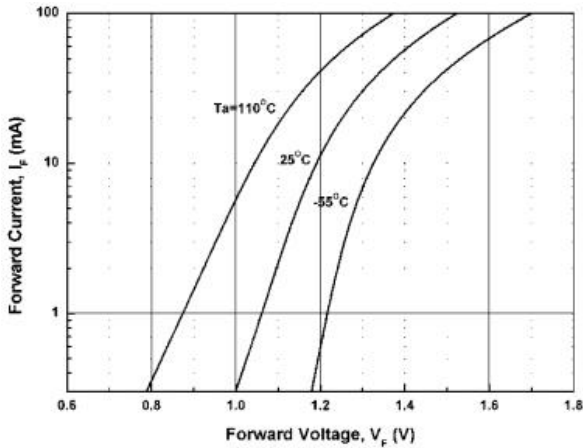

图2 电流传输比与正向电流的关系

Fig.2 Current Transfer Ratio vs Forward Current

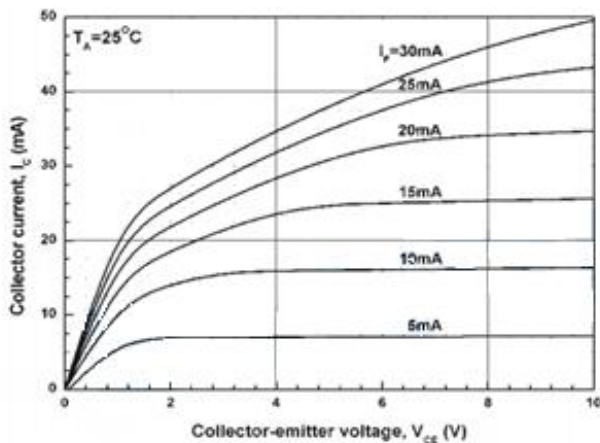

图4 相对电流传输比与环境温度的关系

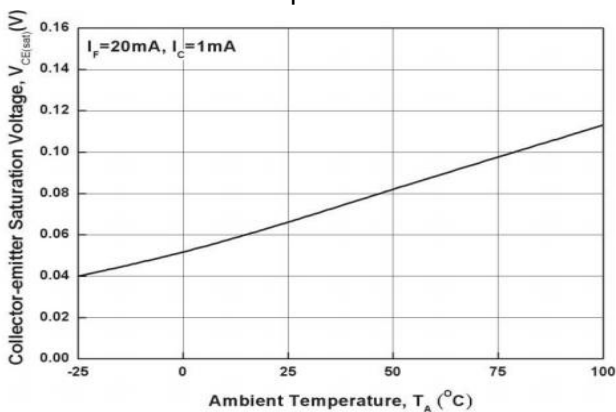
Fig.4 Relative Current Transfer Ratio vs Ambient Temperature



图6 暗电流与环境温度的关系
Fig.6 Dark Current vs Ambient Temperature

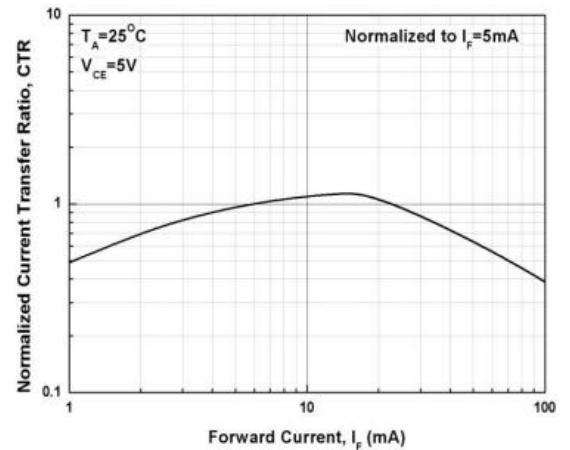

图7. 开关时间与负载电阻的关系

Fig.7 Switching Time vs Load Resistance

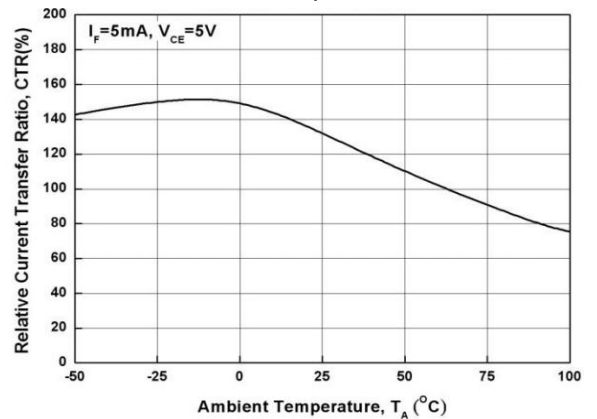

图8.集电极-发射极饱和电压与正向电流的关系

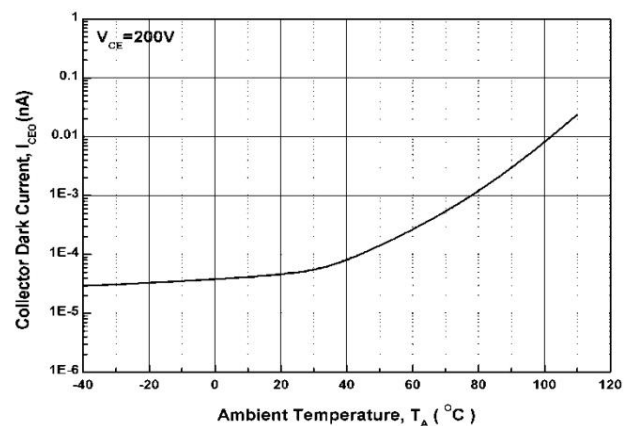
Fig.8 Collector-emitter Saturation Voltage vs Forward Current

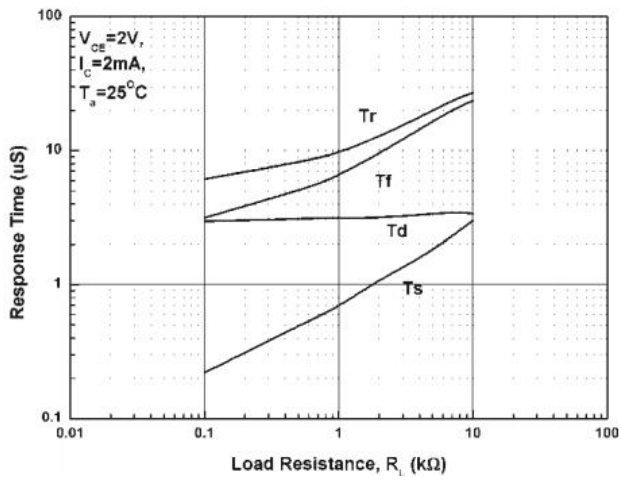

图9 开关时间测试电路及波形

Fig 9. Switching Time Test Circuit & Waveforms

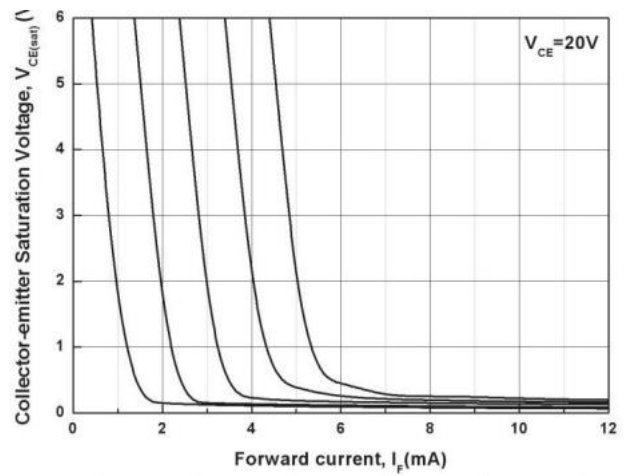
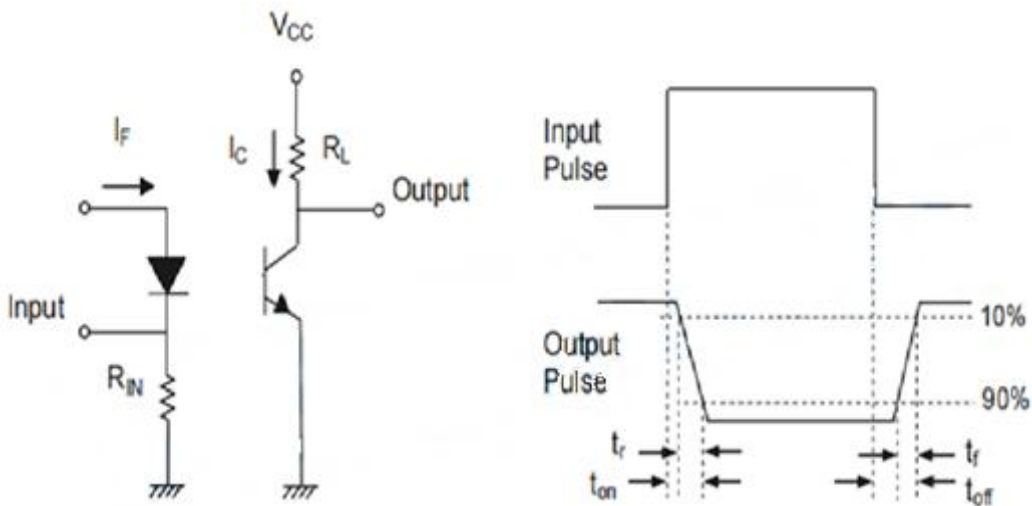

9. 订单信息 Order Information

• 零件编号 Part Number

KL851-YZ

附注(Notes):

- Y = 表示引脚形式选项(S1、M或无)
 Lead form option (S1, M or none)
- Z = 表示料带和卷盘选项(TA, TB, TU, TD 或 无)
 Tape and reel option (TA, TB, TU, TD or none)

选项 Option	描述 Description	包装数量 Packing quantity
直脚None	标准DIP-4 Standard DIP-4	每管100pcs 100 units per tube
M脚	折弯脚(0.4英寸间距) Wide lead bend (0.4 inch spacing)	每管100pcs 100 units per tube
S1 (TA)	表面贴装脚型方式(低轮廓)+ TA料带 & 卷轴选择 Surface mount lead form (low profile) + TA tape & reel option	每卷1000pcs 1000 units per reel
S1 (TB)	表面贴装脚型方式(低轮廓)+ TB料带 & 卷轴选择 Surface mount lead form (low profile) + TB tape & reel option	每卷1000pcs 1000 units per reel
S1 (TU)	表面贴装脚型方式(低轮廓)+ TU料带 & 卷轴选择 Surface mount lead form (low profile) + TU tape & reel option	每卷1500pcs 1500 units per reel
S1 (TD)	表面贴装脚型方式(低轮廓)+ TD料带 & 卷轴选择 Surface mount lead form (low profile) + TD tape & reel option	每卷1500pcs 1500 units per reel

10. 包装尺寸(单位:毫米) Package Dimension(Dimension in mm)

• 标准DIP型号 Standard DIP Type

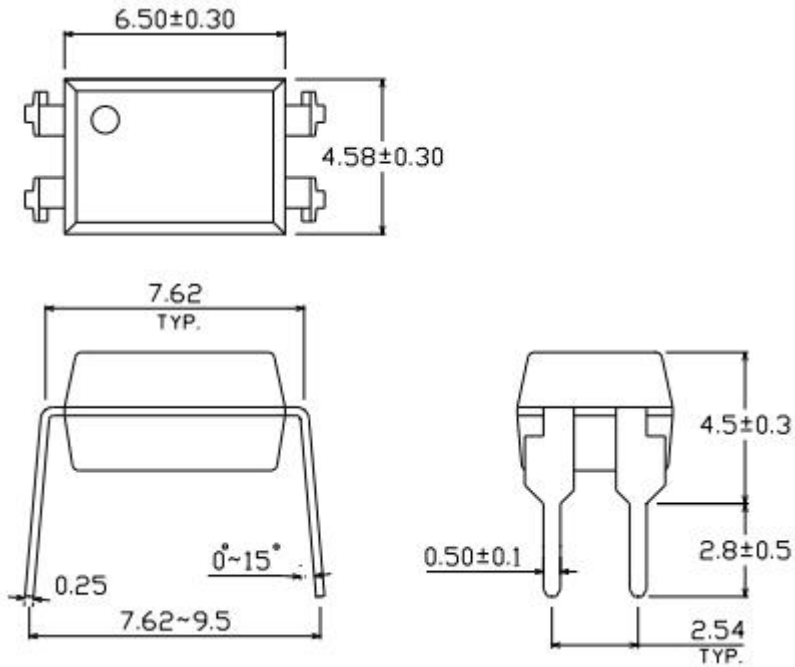

• 选择M型号 Option M Type

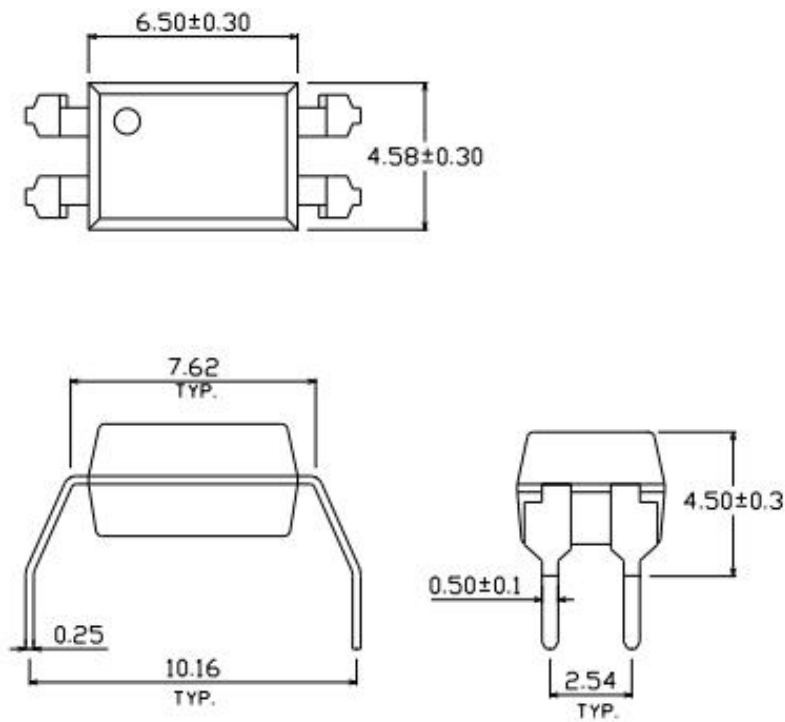

• 选择S1型号 Option S1 Type

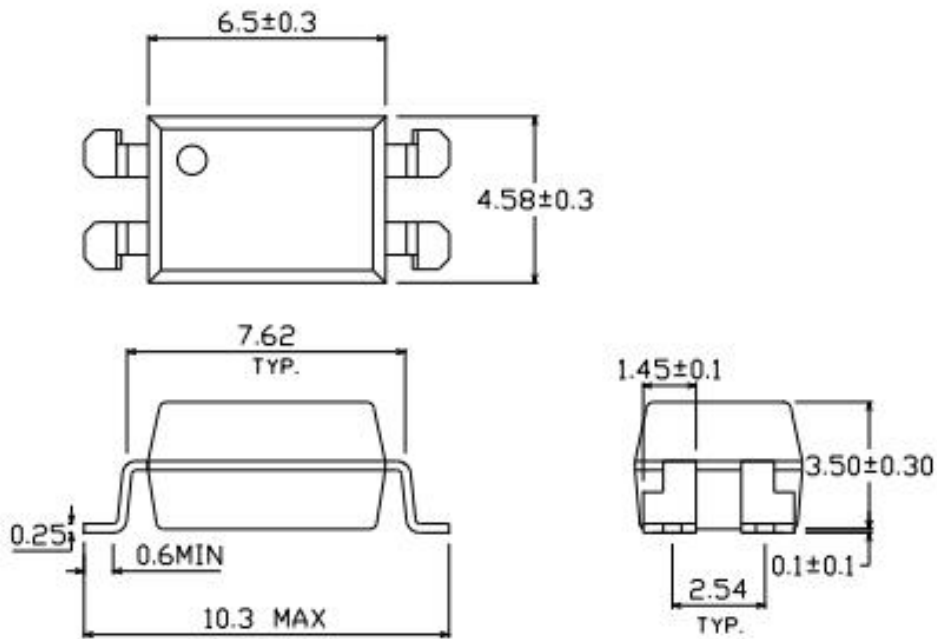

• 表面贴装引线框架 推荐焊盘布局 Recommended pad layout for surface mount leadform

S1脚型焊盘 S1 Options

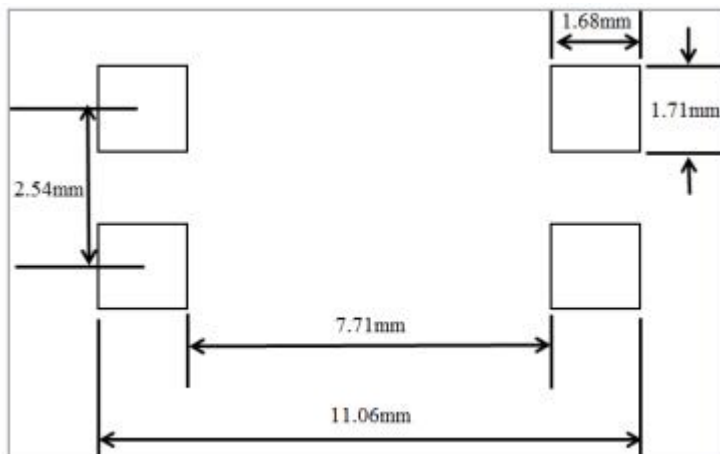

附注(Notes):

- a. 建议焊盘尺寸仅供参考 Suggested pad dimension is just for reference only
- b. 请根据个人需要修改焊盘尺寸 Please modify the pad dimension based on individual need

11. 设备标记 Device marking

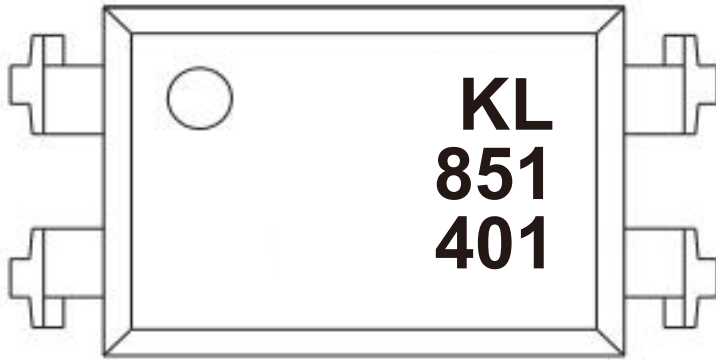

备注Notes

KL = 品牌
851 = 产品型号
4 = 年份代码
01 = 周代码

KL = Brand
851 = Product Model
4 = Year code
01 = Week code

12. 料带和卷轴包装规格 Tape & Reel Packing Specifications

• 选择TA Option TA

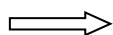
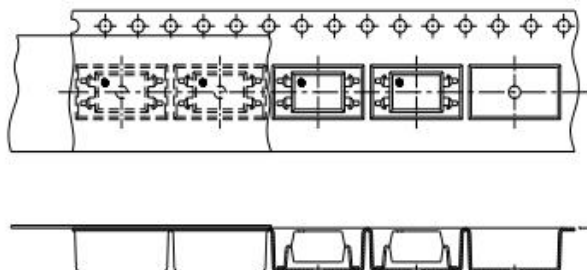

卷轴进给方向 Direction of feed from reel

• 选择TB Option TB

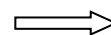
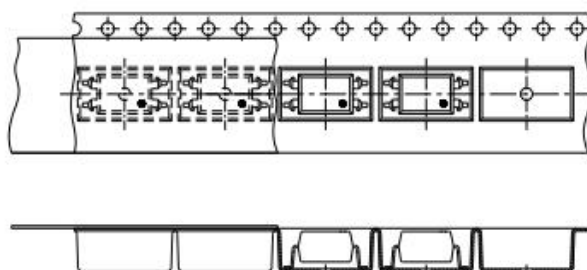

卷轴进给方向 Direction of feed from reel

料带尺寸 Material belt size

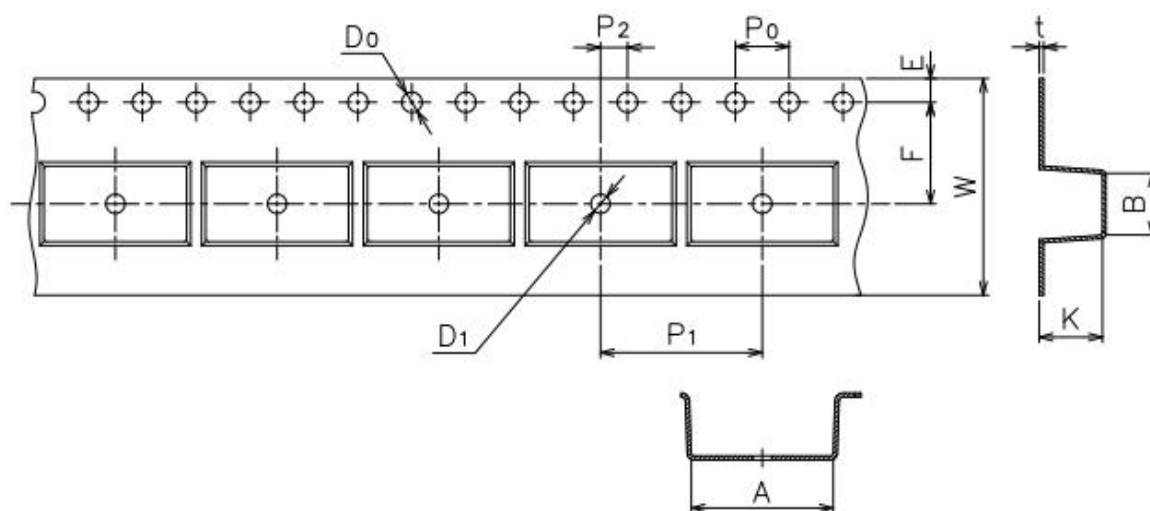

尺寸编号 Dimension No.	A	B	D0	D1	E	F
S1尺寸(mm) S1 Dimension(mm)	10.7±0.1	4.65±0.1	1.5±0.1	1.5±0.1	1.75±0.1	7.5±0.1
尺寸编号 Dimension No.	P0	P1	P2	t	W	K
S1尺寸(mm) S1 Dimension(mm)	4.0±0.1	12.0±0.1	2.0±0.1	0.4±0.1	16.0±0.3	3.9±0.1

料带和卷轴包装规格 Tape & Reel Packing Specifications

• 选择TD Option TD

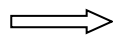
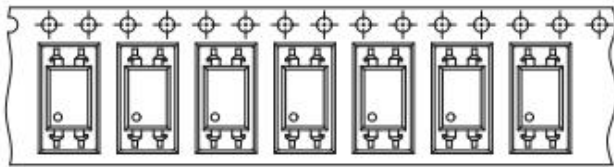

卷轴进给方向 Direction of feed from reel

• 选择TU Option TU

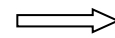
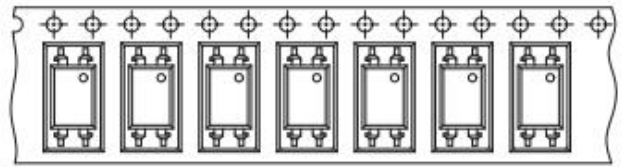

卷轴进给方向 Direction of feed from reel

料带尺寸 Material belt size

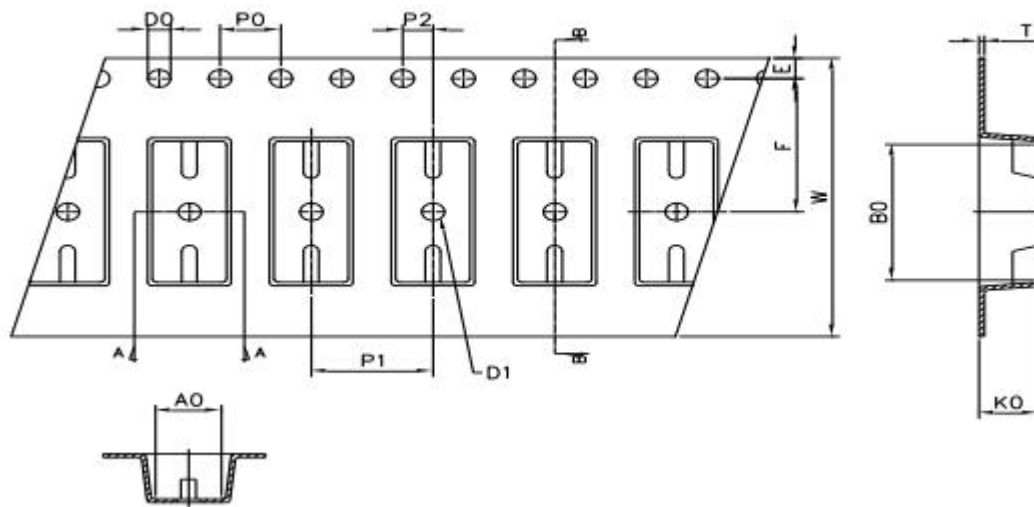

尺寸编号 Dimension No.	A0	B0	D0	D1	E	F
尺寸(mm) Dimension(mm)	4.9±0.1	10.4±0.1	1.5±0.1	1.5±0.1	1.75±0.1	7.5±0.1
尺寸编号 Dimension No.	P0	P1	P2	t	W	K0
尺寸(mm) Dimension(mm)	4.0±0.1	8.0±0.1	2.0±0.1	0.4±0.1	16.0±0.3	4.6±0.1

13. 焊接温度曲线 Temperature Profile Of Soldering

• 回流焊温度曲线 Reflow soldering

建议在下面所示的温度和时间分布条件下, 进行一次回流焊作业, 不得超过三次

One time soldering reflow is recommended within the condition of temperature and time profile shown below. Do not solder more than three times.

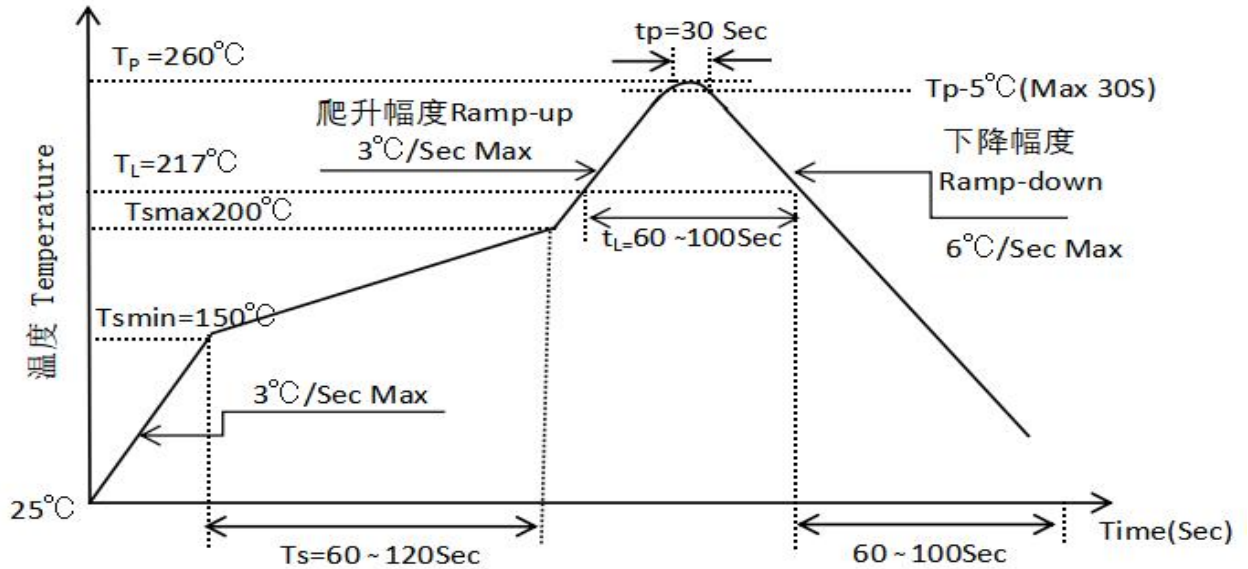

项目 Item	符号 Symbol	最小值 Min.	最大值 Max.	单位 Unit
预热温度 Preheat Temperature	T_s	150	200	°C
预热时间 Preheat Time	t_s	60	120	s
升温速率 Ramp-Up Rate (T_L to T_p)	-	-	3	°C/s
液相线温度 Liquidus Temperature	T_L	217		°C
高于液相线温度(T_L)的时间 Time above Liquidus Temperature T_L	t_L	60	100	s
峰值温度 Peak Temperature	T_p	-	260	°C
T_c 在(T_p-5)和 T_p 之间的时间 Time During Which T_c Is Between (T_p-5) and T_p	t_p	-	30	s
降温速率 Ramp-down Rate(T_p to T_L)	-	-	6	°C/s

• 波峰焊温度曲线 Wave Soldering

温度条件下, 建议一次焊接

One time soldering is recommended within the condition of temperature

