



Features

- 3rd Generation SiC MOSFET technology
- High blocking voltage with low on-resistance
- High speed switching with low capacitances
- Fast intrinsic diode with low reverse recovery (Qrr)
- Halogen free, RoHS compliant

Benefits

- Higher system efficiency
- Reduced cooling requirements
- Increased power density
- Increased system switching frequency

Applications

- Solar inverters
- EV motor drive
- High voltage DC/DC converters
- Switched mode power supplies

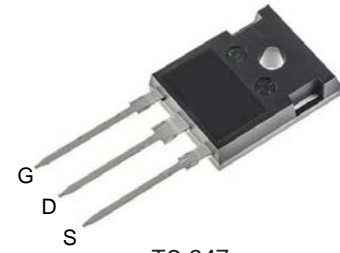

TO-247
Package

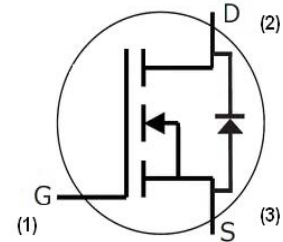

Part Number	Package	Marking
HC3M0015065D	TO-247	HC3M0015065D

Maximum Ratings ($T_c = 25^\circ\text{C}$ unless otherwise specified)

Symbol	Parameter	Value	Unit	Note
V_{DSmax}	Drain - Source Voltage	650	V	
V_{GSmax}	Gate - Source voltage	-8/+19	V	Note 1
I_D	Continuous Drain Current, $V_{GS} = 15\text{ V}$, $T_c = 25^\circ\text{C}$	120	A	Fig. 19 Note 2
	Continuous Drain Current, $V_{GS} = 15\text{ V}$, $T_c = 100^\circ\text{C}$	96		
$I_{D(pulse)}$	Pulsed Drain Current, Pulse width t_p limited by T_{jmax}	418	A	
P_D	Power Dissipation, $T_c = 25^\circ\text{C}$, $T_j = 175^\circ\text{C}$	416	W	Fig. 20
T_J, T_{stg}	Operating Junction and Storage Temperature	-40 to +175	$^\circ\text{C}$	
T_L	Solder Temperature, 1.6mm (0.063") from case for 10s	260	$^\circ\text{C}$	
M_d	Mounting Torque, (M3 or 6-32 screw)	1	Nm lbf-in	
		8.8		

Note (1): Recommended turn off / turn on gate voltage $V_{GS} = -4V \dots 0V / +15V$

Note (2): Package limited to 120 A



Electrical Characteristics ($T_c = 25^\circ\text{C}$ unless otherwise specified)

Symbol	Parameter	Min.	Typ.	Max.	Unit	Test Conditions	Note
$V_{(BR)DSS}$	Drain-Source Breakdown Voltage	650			V	$V_{GS} = 0\text{ V}, I_D = 100\ \mu\text{A}$	
$V_{GS(th)}$	Gate Threshold Voltage	1.8	2.3	3.6	V	$V_{DS} = V_{GS}, I_D = 15.5\ \text{mA}$	Fig. 11
			1.9		V	$V_{DS} = V_{GS}, I_D = 15.5\ \text{mA}, T_J = 175^\circ\text{C}$	
I_{DSS}	Zero Gate Voltage Drain Current		1	50	μA	$V_{DS} = 650\ \text{V}, V_{GS} = 0\ \text{V}$	
I_{GSS}	Gate-Source Leakage Current		10	250	nA	$V_{GS} = 15\ \text{V}, V_{DS} = 0\ \text{V}$	
$R_{DS(on)}$	Drain-Source On-State Resistance	10.5	15	21	m Ω	$V_{GS} = 15\ \text{V}, I_D = 55.8\ \text{A}$	Fig. 4, 5, 6
			20			$V_{GS} = 15\ \text{V}, I_D = 55.8\ \text{A}, T_J = 175^\circ\text{C}$	
g_{fs}	Transconductance		42		S	$V_{DS} = 20\ \text{V}, I_{DS} = 55.8\ \text{A}$	Fig. 7
			40			$V_{DS} = 20\ \text{V}, I_{DS} = 55.8\ \text{A}, T_J = 175^\circ\text{C}$	
C_{iss}	Input Capacitance		5011		pF	$V_{GS} = 0\ \text{V}, V_{DS} = 400\ \text{V}$ $f = 100\ \text{Khz}$ $V_{AC} = 25\ \text{mV}$	Fig. 17, 18
C_{oss}	Output Capacitance		289				
C_{rss}	Reverse Transfer Capacitance		31				
$C_{o(er)}$	Effective Output Capacitance (Energy Related)		357				Note: 3
$C_{o(tr)}$	Effective Output Capacitance (Time Related)		516				Note: 3
E_{oss}	C_{oss} Stored Energy		29		μJ		Fig. 16
E_{ON}	Turn-On Switching Energy (Body Diode)		1500		μJ	$V_{DS} = 400\ \text{V}, V_{GS} = -4\ \text{V}/15\ \text{V}, I_D = 55.8\ \text{A},$ $R_{G(ext)} = 5\ \Omega, L = 57.6\ \mu\text{H}, T_J = 175^\circ\text{C}$ FWD = Internal Body Diode of MOSFET	Fig. 25
E_{OFF}	Turn Off Switching Energy (Body Diode)		700				
E_{ON}	Turn-On Switching Energy (External Diode)		1200		μJ	$V_{DS} = 400\ \text{V}, V_{GS} = -4\ \text{V}/15\ \text{V}, I_D = 55.8\ \text{A},$ $R_{G(ext)} = 5\ \Omega, L = 57.6\ \mu\text{H}, T_J = 175^\circ\text{C}$ FWD = External SiC DIODE	Fig. 25
E_{OFF}	Turn Off Switching Energy (External Diode)		1000				
$t_{d(on)}$	Turn-On Delay Time		22		ns	$V_{DD} = 400\ \text{V}, V_{GS} = -4\ \text{V}/15\ \text{V}$ $I_D = 55.8\ \text{A}, R_{G(ext)} = 5\ \Omega, L = 57.6\ \mu\text{H}$ Timing relative to V_{DS} Inductive load	Fig. 26
t_r	Rise Time		125				
$t_{d(off)}$	Turn-Off Delay Time		58				
t_f	Fall Time		25				
$R_{G(int)}$	Internal Gate Resistance		1.5		Ω	$f = 1\ \text{MHz}, V_{AC} = 25\ \text{mV}$	
Q_{gs}	Gate to Source Charge		54		nC	$V_{DS} = 400\ \text{V}, V_{GS} = -4\ \text{V}/15\ \text{V}$ $I_D = 55.8\ \text{A}$ Per IEC60747-8-4 pg 21	Fig. 12
Q_{gd}	Gate to Drain Charge		62				
Q_g	Total Gate Charge		188				

Note (3): $C_{o(er)}$, a lumped capacitance that gives same stored energy as C_{oss} while V_{ds} is rising from 0 to 400V
 $C_{o(tr)}$, a lumped capacitance that gives same charging time as C_{oss} while V_{ds} is rising from 0 to 400V



Reverse Diode Characteristics ($T_C = 25^\circ\text{C}$ unless otherwise specified)

Symbol	Parameter	Typ.	Max.	Unit	Test Conditions	Note
V_{SD}	Diode Forward Voltage	4.7		V	$V_{GS} = -4\text{ V}, I_{SD} = 27.9\text{ A}, T_J = 25^\circ\text{C}$	Fig. 8, 9, 10
		4.2		V	$V_{GS} = -4\text{ V}, I_{SD} = 27.9\text{ A}, T_J = 175^\circ\text{C}$	
I_S	Continuous Diode Forward Current		79	A	$V_{GS} = -4\text{ V}, T_C = 25^\circ\text{C}$	
$I_{S, pulse}$	Diode pulse Current		418	A	$V_{GS} = -4\text{ V}$, pulse width t_p limited by T_{jmax}	
t_{rr}	Reverse Recovery time	85		ns	$V_{GS} = -4\text{ V}, I_{SD} = 55.8\text{ A}, V_R = 400\text{ V}$ $dif/dt = 1500\text{ A}/\mu\text{s}, T_J = 175^\circ\text{C}$	
Q_{rr}	Reverse Recovery Charge	667		nC		
I_{rrm}	Peak Reverse Recovery Current	17		A		
t_{rr}	Reverse Recovery time	74		ns	$V_{GS} = -4\text{ V}, I_{SD} = 55.8\text{ A}, V_R = 400\text{ V}$ $dif/dt = 1000\text{ A}/\mu\text{s}, T_J = 175^\circ\text{C}$	
Q_{rr}	Reverse Recovery Charge	562		nC		
I_{rrm}	Peak Reverse Recovery Current	14		A		

Thermal Characteristics

Symbol	Parameter	Typ.	Unit	Test Conditions	Note
$R_{\theta JC}$	Thermal Resistance from Junction to Case	0.35	$^\circ\text{C}/\text{W}$		Fig. 21
$R_{\theta JA}$	Thermal Resistance From Junction to Ambient	40			



Typical Performance

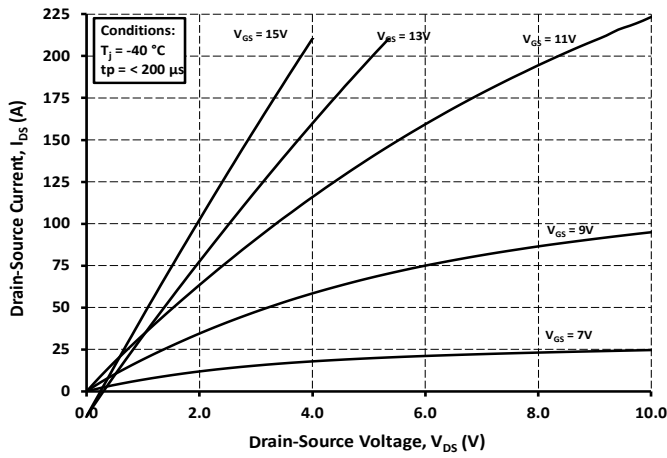

Figure 1. Output Characteristics $T_j = -40\text{ }^\circ\text{C}$

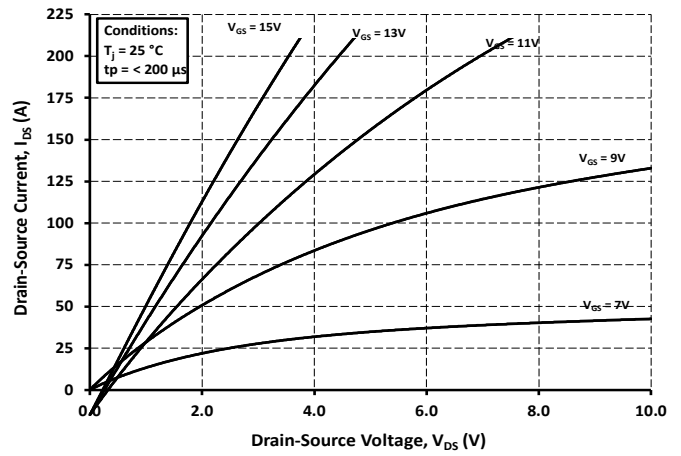

Figure 2. Output Characteristics $T_j = 25\text{ }^\circ\text{C}$

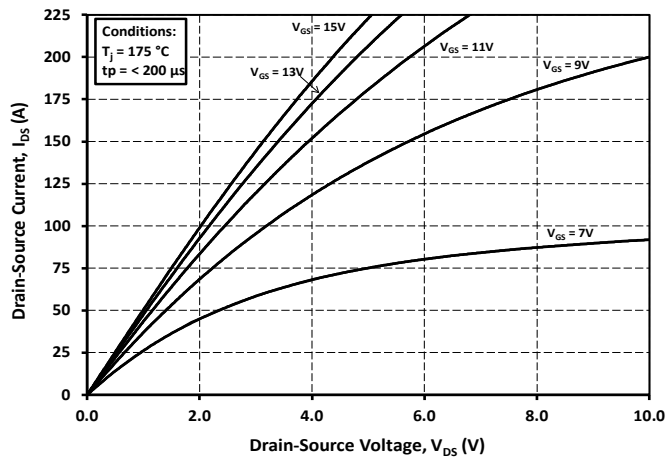

Figure 3. Output Characteristics $T_j = 175\text{ }^\circ\text{C}$

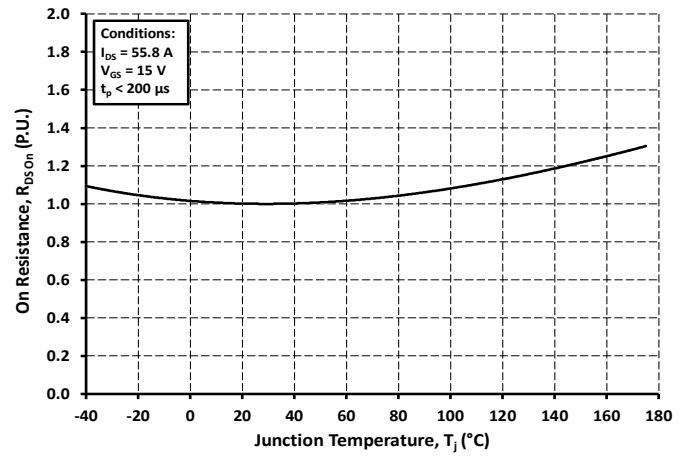

Figure 4. Normalized On-Resistance vs. Temperature

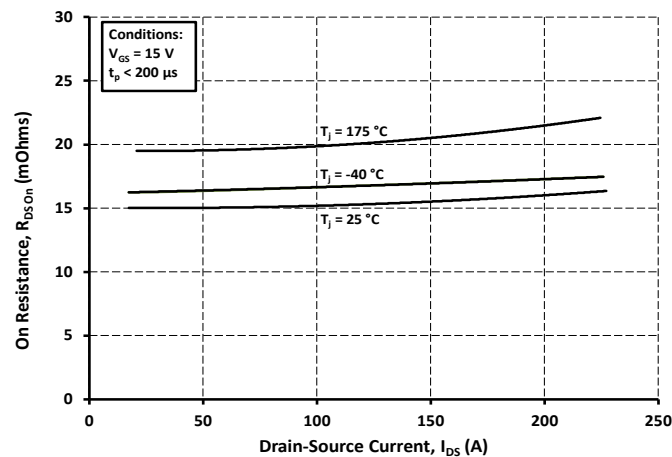

Figure 5. On-Resistance vs. Drain Current For Various Temperatures

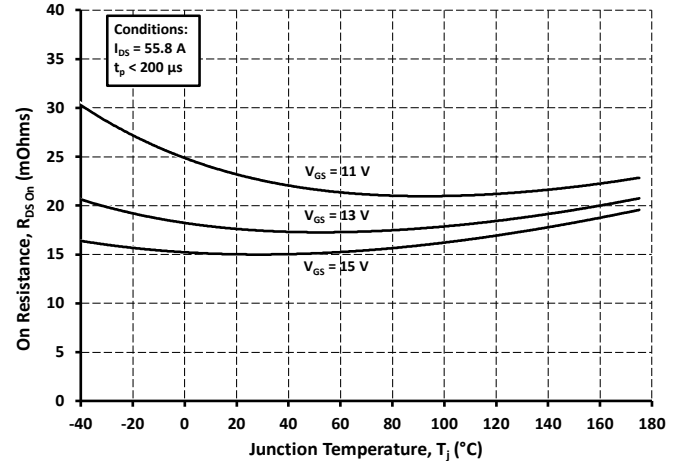

Figure 6. On-Resistance vs. Temperature For Various Gate Voltage



Typical Performance

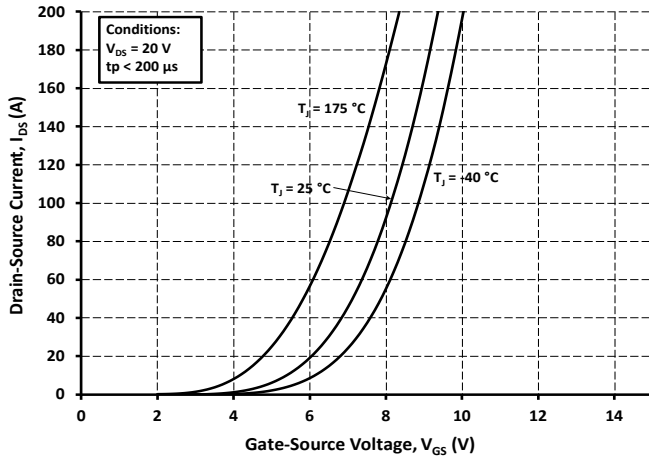

Figure 7. Transfer Characteristic for Various Junction Temperatures

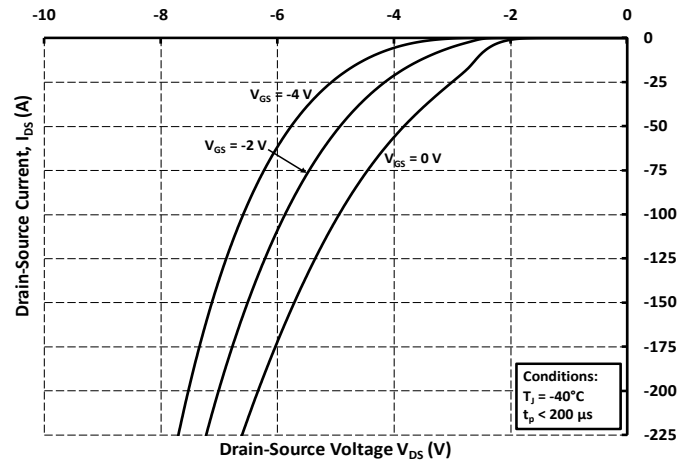

Figure 8. Body Diode Characteristic at $-40\text{ }^\circ\text{C}$

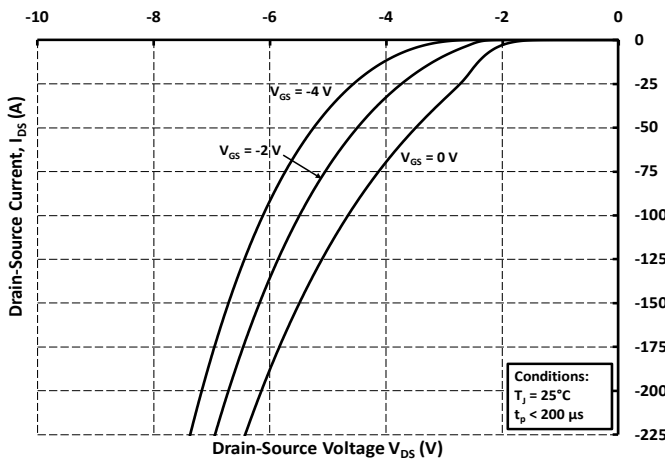

Figure 9. Body Diode Characteristic at $25\text{ }^\circ\text{C}$

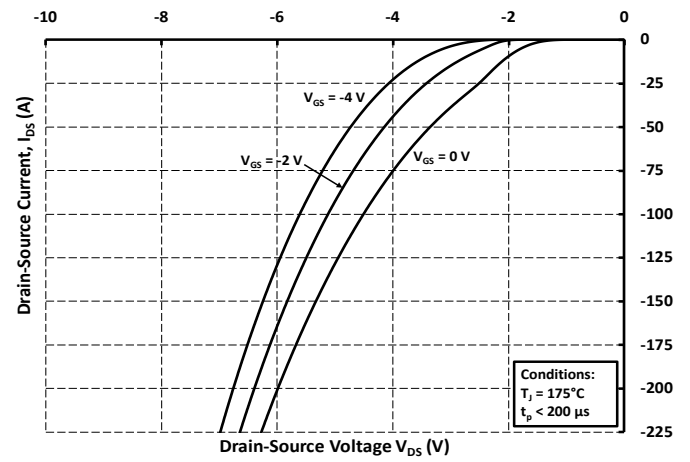

Figure 10. Body Diode Characteristic at $175\text{ }^\circ\text{C}$

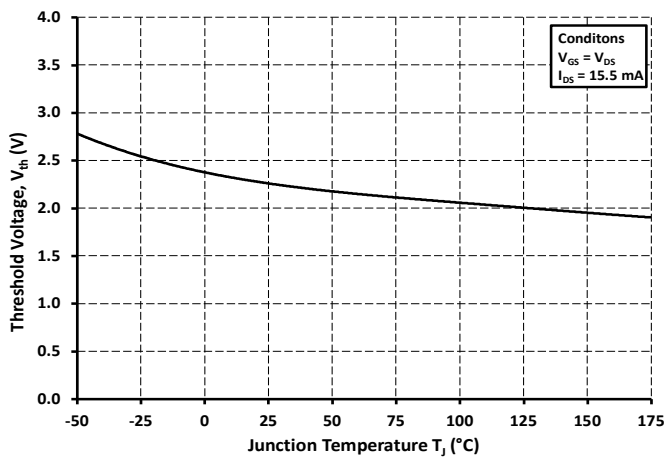

Figure 11. Threshold Voltage vs. Temperature

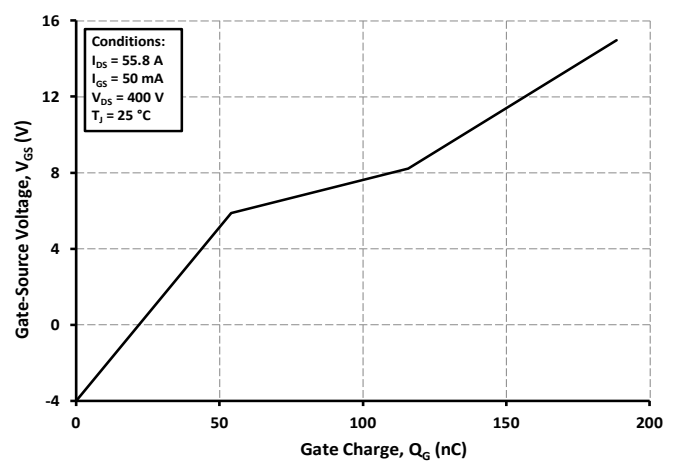

Figure 12. Gate Charge Characteristics



Typical Performance

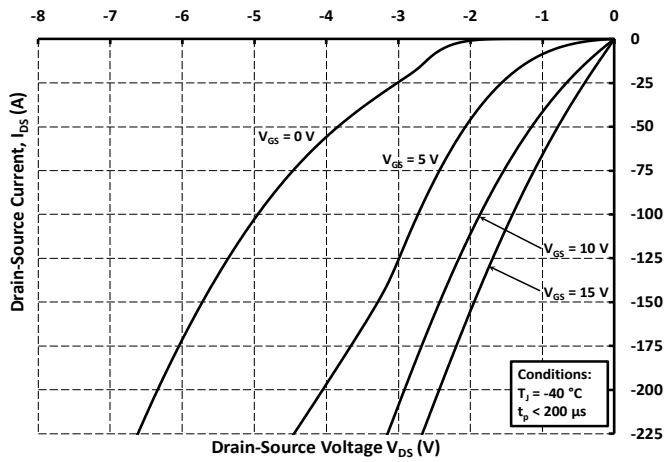

Figure 13. 3rd Quadrant Characteristic at -40 °C

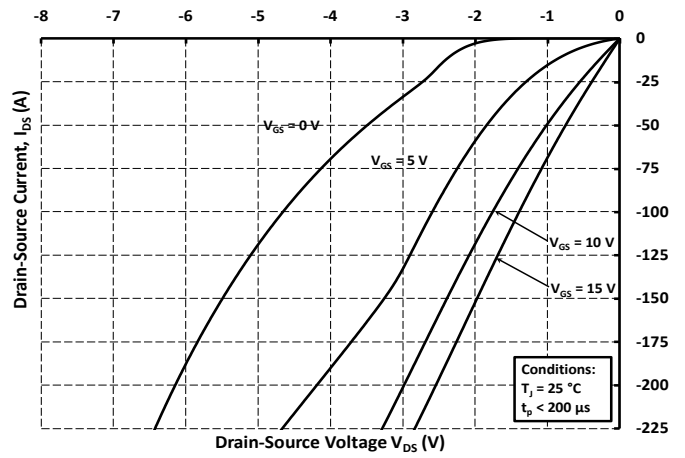

Figure 14. 3rd Quadrant Characteristic at 25 °C

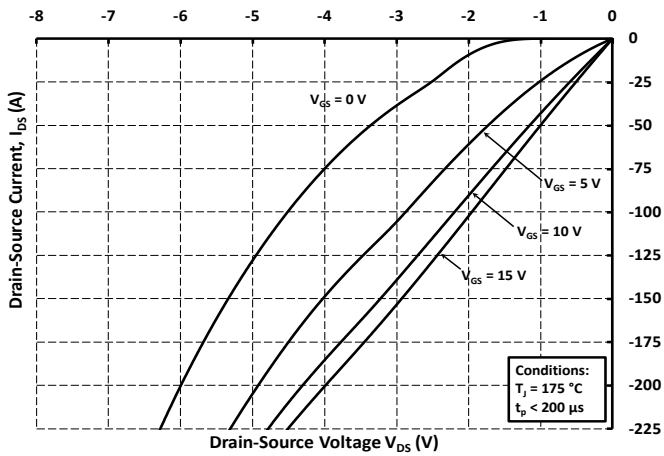

Figure 15. 3rd Quadrant Characteristic at 175 °C

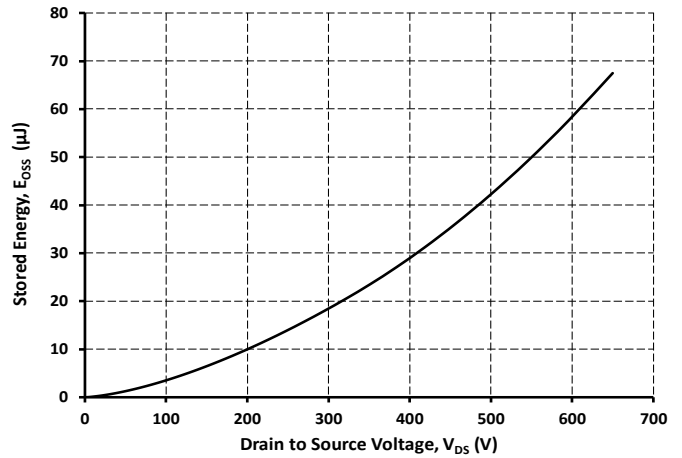

Figure 16. Output Capacitor Stored Energy

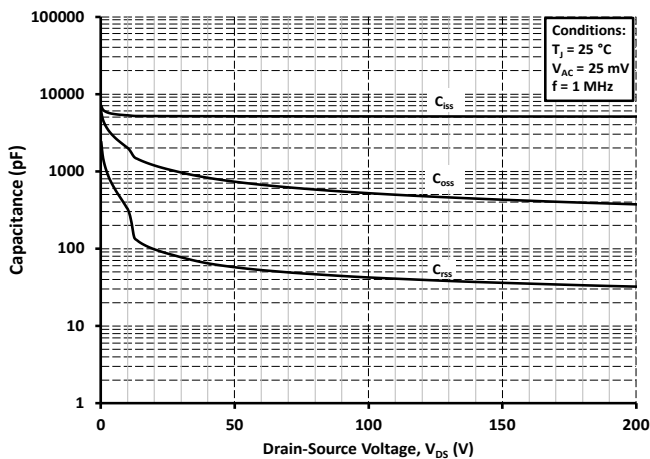

Figure 17. Capacitances vs. Drain-Source Voltage (0 - 200V)

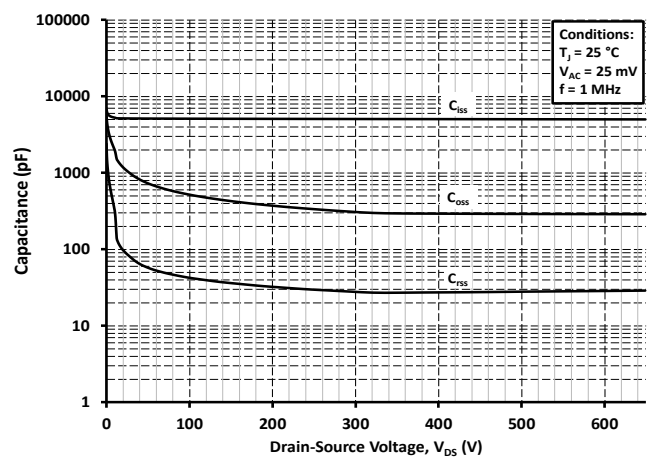

Figure 18. Capacitances vs. Drain-Source Voltage (0 - 650V)



Typical Performance

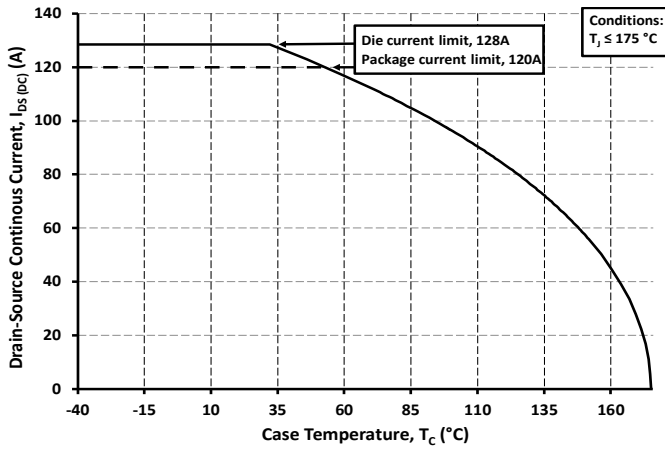

Figure 19. Continuous Drain Current Derating vs. Case Temperature

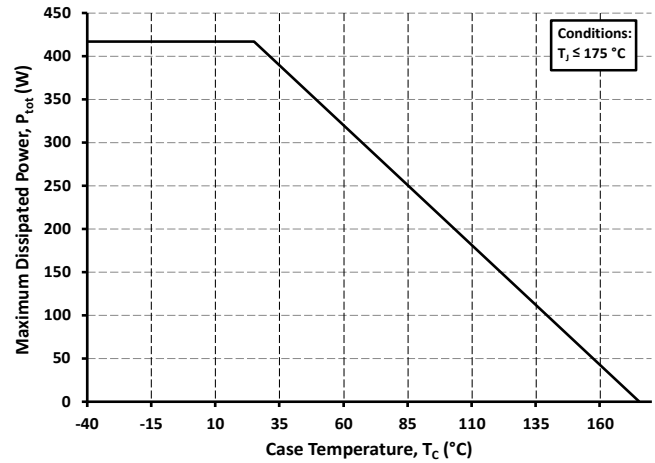

Figure 20. Maximum Power Dissipation Derating vs. Case Temperature

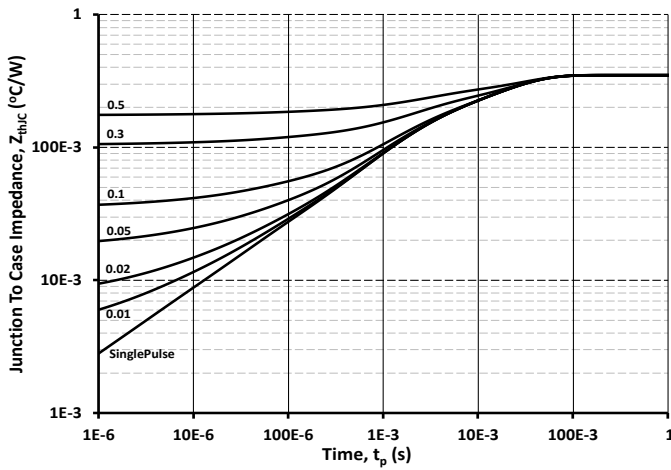

Figure 21. Transient Thermal Impedance (Junction - Case)

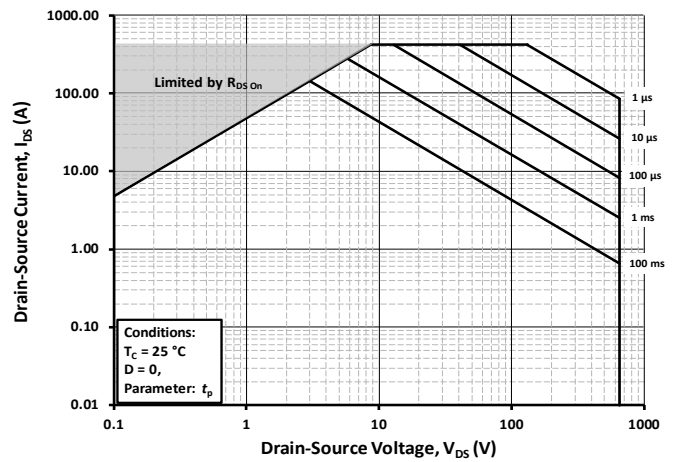

Figure 22. Safe Operating Area

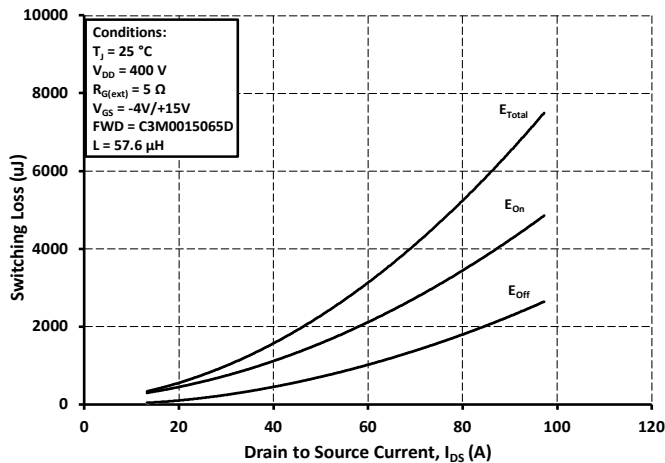

Figure 23. Clamped Inductive Switching Energy vs. Drain Current ($V_{DD} = 400V$)

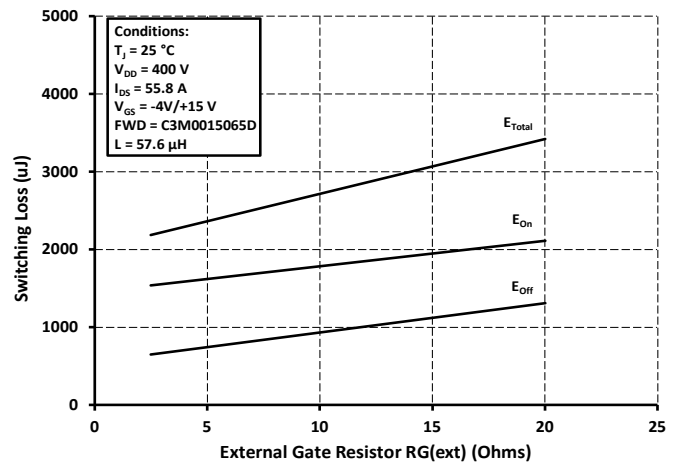

Figure 24. Clamped Inductive Switching Energy vs. $R_{G(ext)}$



Typical Performance

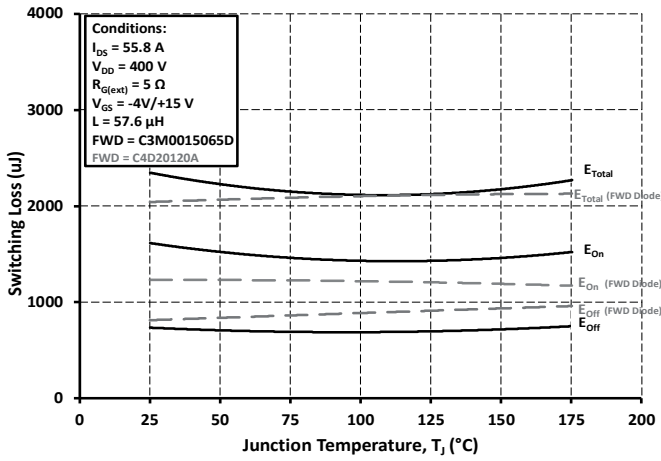

Figure 25. Clamped Inductive Switching Energy vs. Temperature

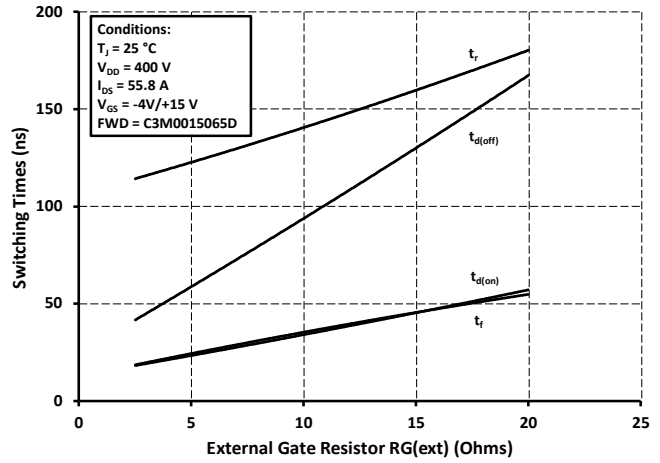

Figure 26. Switching Times vs. $R_{G(ext)}$



Test Circuit Schematic

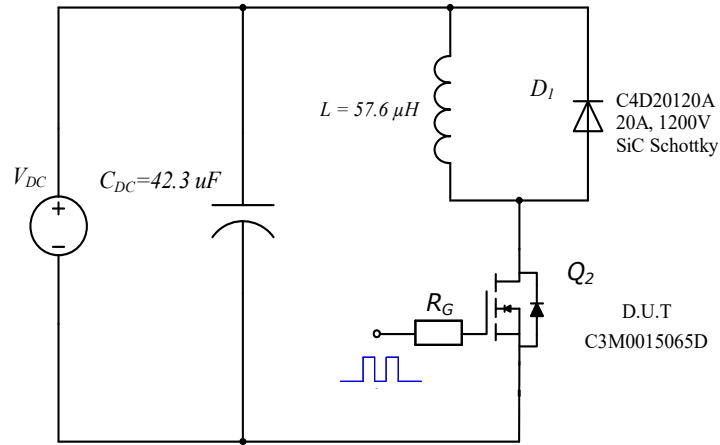

Figure 27. Clamped Inductive Switching
Waveform Test Circuit

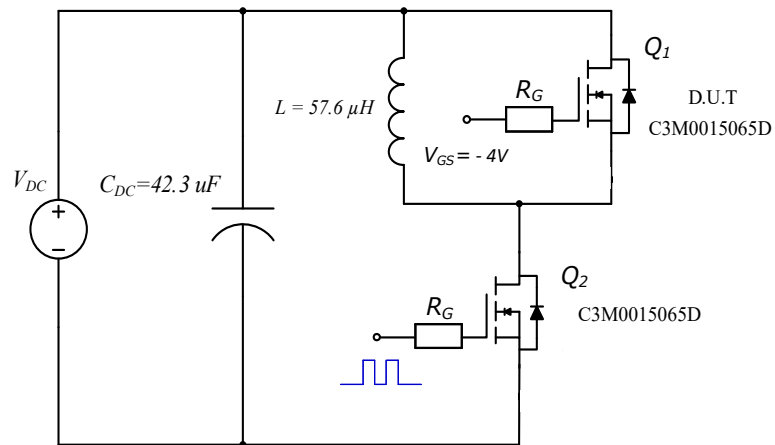
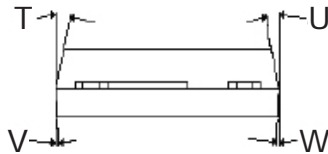
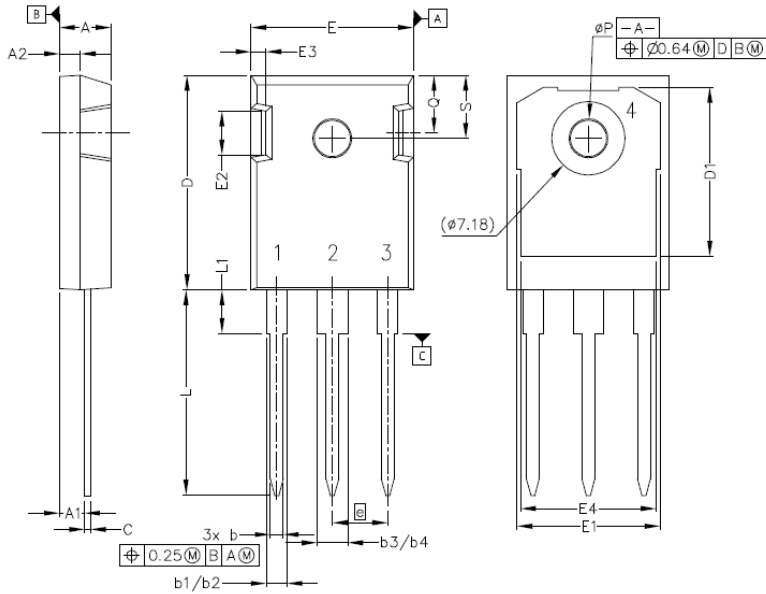

Figure 28. Body Diode Recovery Test Circuit



Package Dimensions

Package TO-247



Pinout Information:

- Pin 1 = Gate
- Pin 2, 4 = Drain
- Pin 3 = Source

POS	Inches		Millimeters	
	Min	Max	Min	Max
A	.190	.205	4.83	5.21
A1	.090	.100	2.29	2.54
A2	.075	.085	1.91	2.16
b	.042	.052	1.07	1.33
b1	.075	.095	1.91	2.41
b2	.075	.085	1.91	2.16
b3	.113	.133	2.87	3.38
b4	.113	.123	2.87	3.13
c	.022	.027	0.55	0.68
D	.819	.831	20.80	21.10
D1	.640	.695	16.25	17.65
D2	.037	.049	0.95	1.25
E	.620	.635	15.75	16.13
E1	.516	.557	13.10	14.15
E2	.145	.201	3.68	5.10
E3	.039	.075	1.00	1.90
E4	.487	.529	12.38	13.43
e	.214 BSC		5.44 BSC	
N	3		3	
L	.780	.800	19.81	20.32
L1	.161	.173	4.10	4.40
ØP	.138	.144	3.51	3.65
Q	.216	.236	5.49	6.00
S	.238	.248	6.04	6.30
T	9°	11°	9°	11°
U	9°	11°	9°	11°
V	2°	8°	2°	8°
W	2°	8°	2°	8°

Recommended Solder Pad Layout

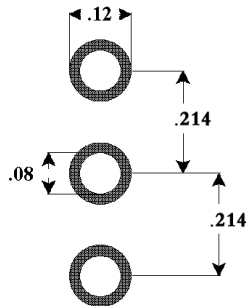

TO-247



Attention

- Any and all HUA XUAN YANG ELECTRONICS products described or contained herein do not have specifications that can handle applications that require extremely high levels of reliability, such as life-support systems, aircraft's control systems, or other applications whose failure can be reasonably expected to result in serious physical and/or material damage. Consult with your HUA XUAN YANG ELECTRONICS representative nearest you before using any HUA XUAN YANG ELECTRONICS products described or contained herein in such applications.
- HUA XUAN YANG ELECTRONICS assumes no responsibility for equipment failures that result from using products at values that exceed, even momentarily, rated values (such as maximum ratings, operating condition ranges, or other parameters) listed in products specifications of any and all HUA XUAN YANG ELECTRONICS products described or contained herein.
- Specifications of any and all HUA XUAN YANG ELECTRONICS products described or contained herein stipulate the performance, characteristics, and functions of the described products in the independent state, and are not guarantees of the performance, characteristics, and functions of the described products as mounted in the customer's products or equipment. To verify symptoms and states that cannot be evaluated in an independent device, the customer should always evaluate and test devices mounted in the customer's products or equipment.
- HUA XUAN YANG ELECTRONICS CO.,LTD. strives to supply high-quality high-reliability products. However, any and all semiconductor products fail with some probability. It is possible that these probabilistic failures could give rise to accidents or events that could endanger human lives, that could give rise to smoke or fire, or that could cause damage to other property. When designing equipment, adopt safety measures so that these kinds of accidents or events cannot occur. Such measures include but are not limited to protective circuits and error prevention circuits for safe design, redundant design, and structural design.
- In the event that any or all HUA XUAN YANG ELECTRONICS products(including technical data, services) described or contained herein are controlled under any of applicable local export control laws and regulations, such products must not be exported without obtaining the export license from the authorities concerned in accordance with the above law.
- No part of this publication may be reproduced or transmitted in any form or by any means, electronic or mechanical, including photocopying and recording, or any information storage or retrieval system, or otherwise, without the prior written permission of HUA XUAN YANG ELECTRONICS CO.,LTD.
- Information (including circuit diagrams and circuit parameters) herein is for example only ; it is not guaranteed for volume production. HUA XUAN YANG ELECTRONICS believes information herein is accurate and reliable, but no guarantees are made or implied regarding its use or any infringements of intellectual property rights or other rights of third parties.
- Any and all information described or contained herein are subject to change without notice due to product/technology improvement, etc. When designing equipment, refer to the "Delivery Specification" for the HUA XUAN YANG ELECTRONICS product that you intend to use.